

G450

DRIFTDOWN PROCEDURES AND SYSTEMS' ASSESSMENT

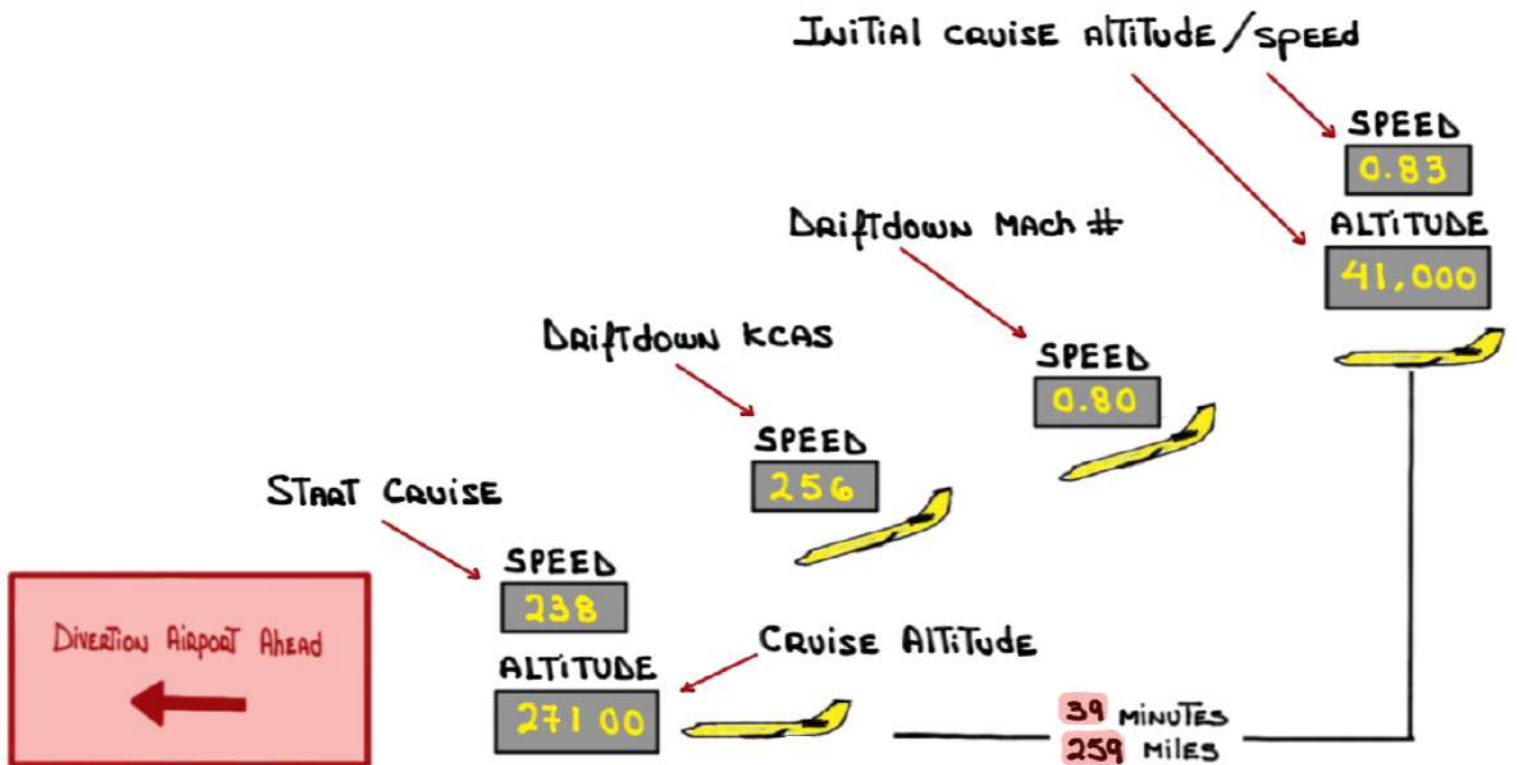

For study purposes only

PART I

- NOATH ATLANTIC (NAT) / High LEVEL
AIRSPACE (HLA)
- ORGANIZED TRACK SYSTEM (OTS)
- RANDOM ROUTES
- EQUAL TIME POINT (ETP)
- NAT OPS BULLETIN 2018-005
- DEVIATIONS AROUND SEVERE WEATHER
- WAKE TURBULENCE

NORTH ATLANTIC (NAT)

High LEVEL AIRSPACE (HLA)

① ICAO NAT Doc 007 - AIRSPACE MANUAL

② VOLUME of AIRSPACE BETWEEN **FL 285** AND **FL 420**

WITHIN THE OCEANIC CONTROL AREAS of:

- Bodo OCEANIC
- GANDER OCEANIC
- NEW YORK OCEANIC EAST
- REYKJAVIK
- SANTA MARIA
- SHANWICK

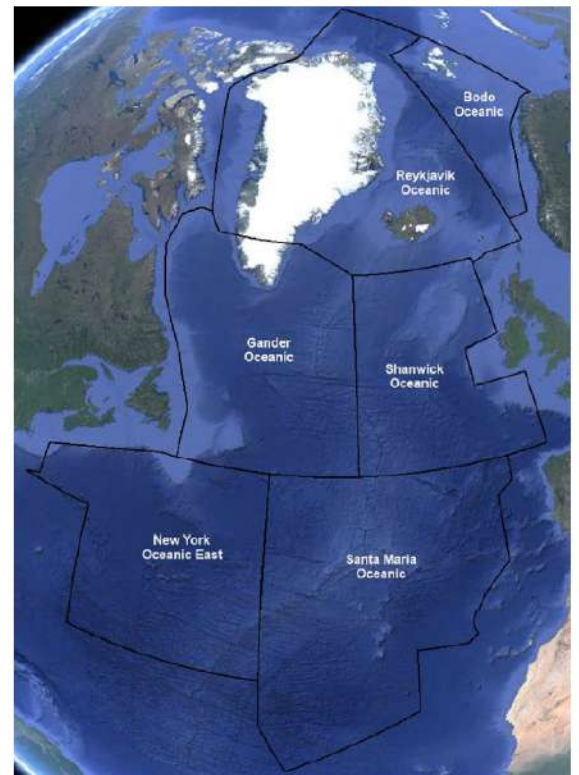
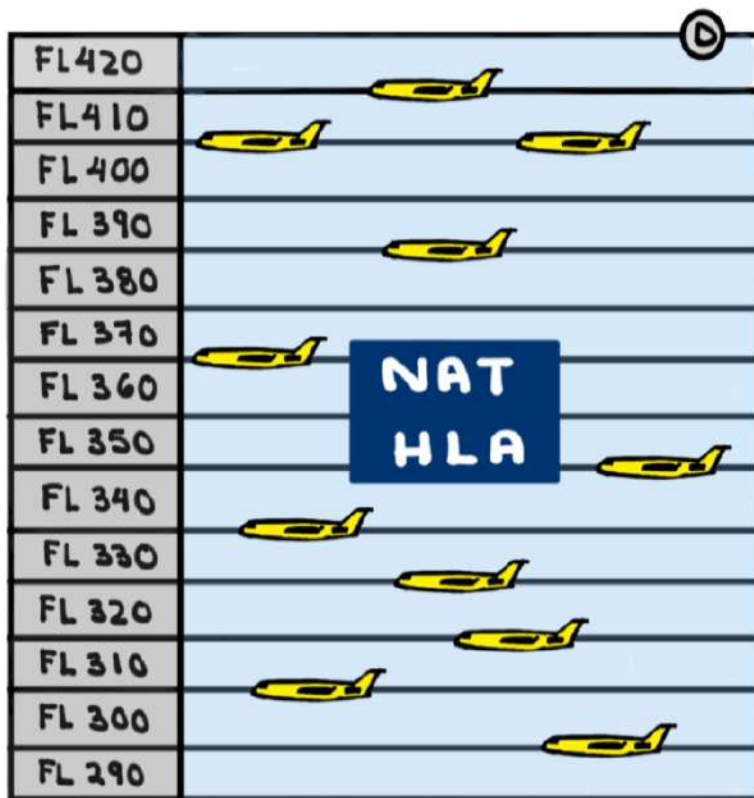

ORGANIZED TRACK SYSTEM (OTS)

- ① UNI-DIRECTIONAL AND CONCENTRATED flow of TRAFFIC BETWEEN NORTH AMERICA AND EUROPE
- ② THE OTS CONSISTS OF TWO (2) MAJOR ALTERNATING flows:
 - A WESTBOUND flow DEPARTING EUROPE IN THE MORNING

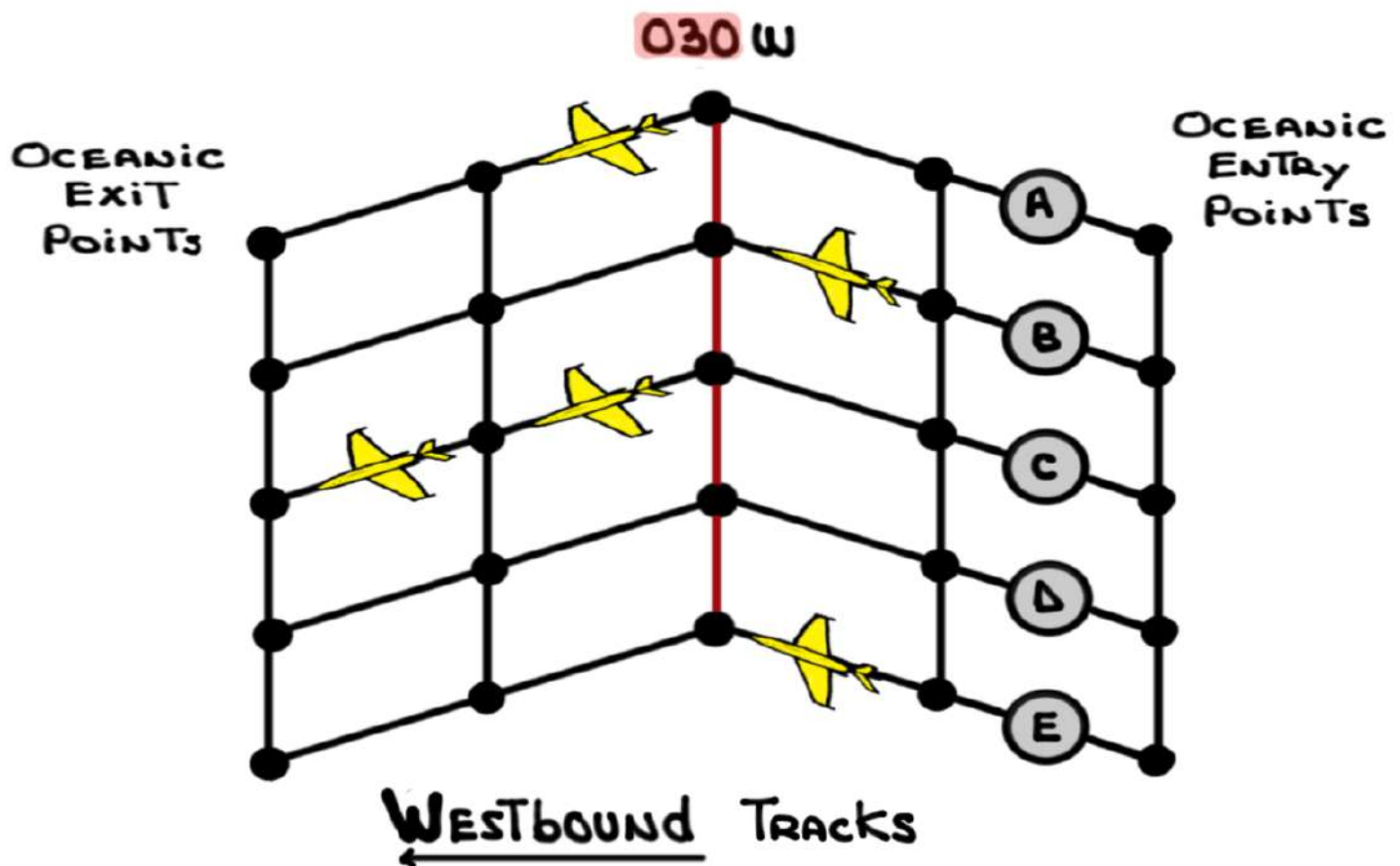

- AN EASTBOUND flow DEPARTING NORTH AMERICA IN THE EVENING

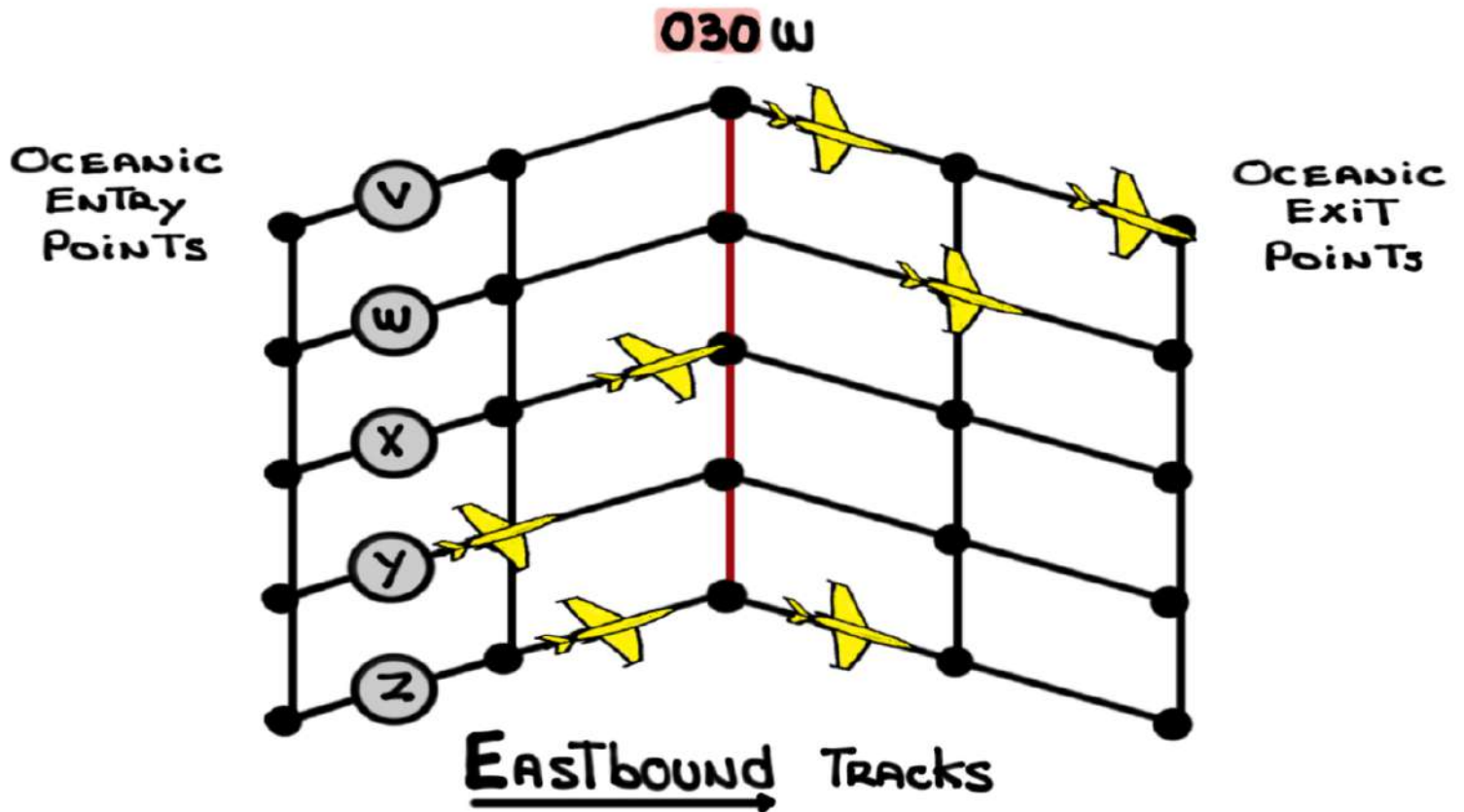

- ③ WESTBOUND TRAFFIC CROSSES 030 W BETWEEN 1130 - 1930 Z. OTS TRACKS ARE PUBLISHED BY SHANWICK AT 2200 Z
- ④ EASTBOUND TRAFFIC CROSSES 030 W BETWEEN 0100 - 0800 Z. OTS TRACKS ARE PUBLISHED BY GANDER AT 1400 Z

- ⑤ TRACKS ARE BASED ON MINIMUM TIME
- ⑥ FL340 To FL400
- ⑦ A TRACK MESSAGE IDENTIFICATION (TMI) NUMBER PROVIDES OTS COORDINATES AND FLIGHT LEVELS AVAILABLE ON EACH TRACK
- ⑧ SPECIAL AUTHORIZATION, INCLUDING RVSM, IS REQUIRED
- ⑨ THE NAT'S OTS PRESENTS CONSIDERABLE CHALLENGES:
- VERY CONGESTED OCEANIC AIRSPACE WITH REDUCED VERTICAL AND HORIZONTAL SEPARATION
 - LARGE DISTANCES TO A LIMITED NUMBER OF SUITABLE ALTERNATE AIRPORTS
 - NO ATC RADAR SURVEILLANCE
 - DIRECT PILOT-CONTROLLER VOICE COMMUNICATION IS LIMITED

⑩ VERTICAL SEPARATION

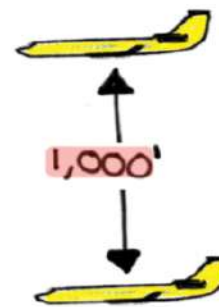

⑪ LATERAL SEPARATION

PBCS TRACK

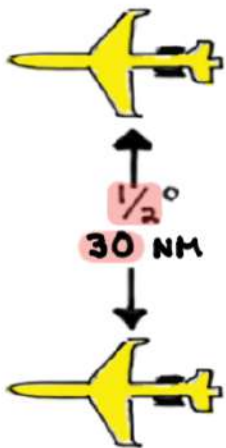

- PERFORMANCE-BASED COMMUNICATION & SURVEILLANCE
- FL 350 - FL 390
- PBCS AUTHORIZATION REQUIRED

Non-PBCS TRACK

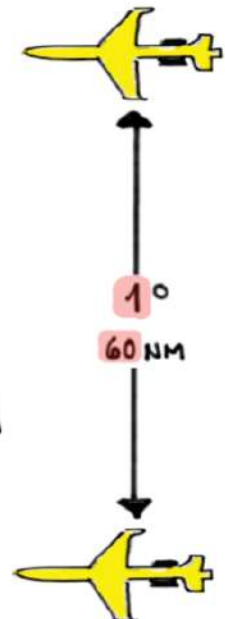

⑫ LONGITUDINAL SEPARATION (MACH NUMBER TECHNIQUE)



Non-PBCS TRACK



PBCS TRACK

RANDOM ROUTES

① RANDOM ROUTES ARE THOSE WHICH REMAIN CLEAR OF THE OTS

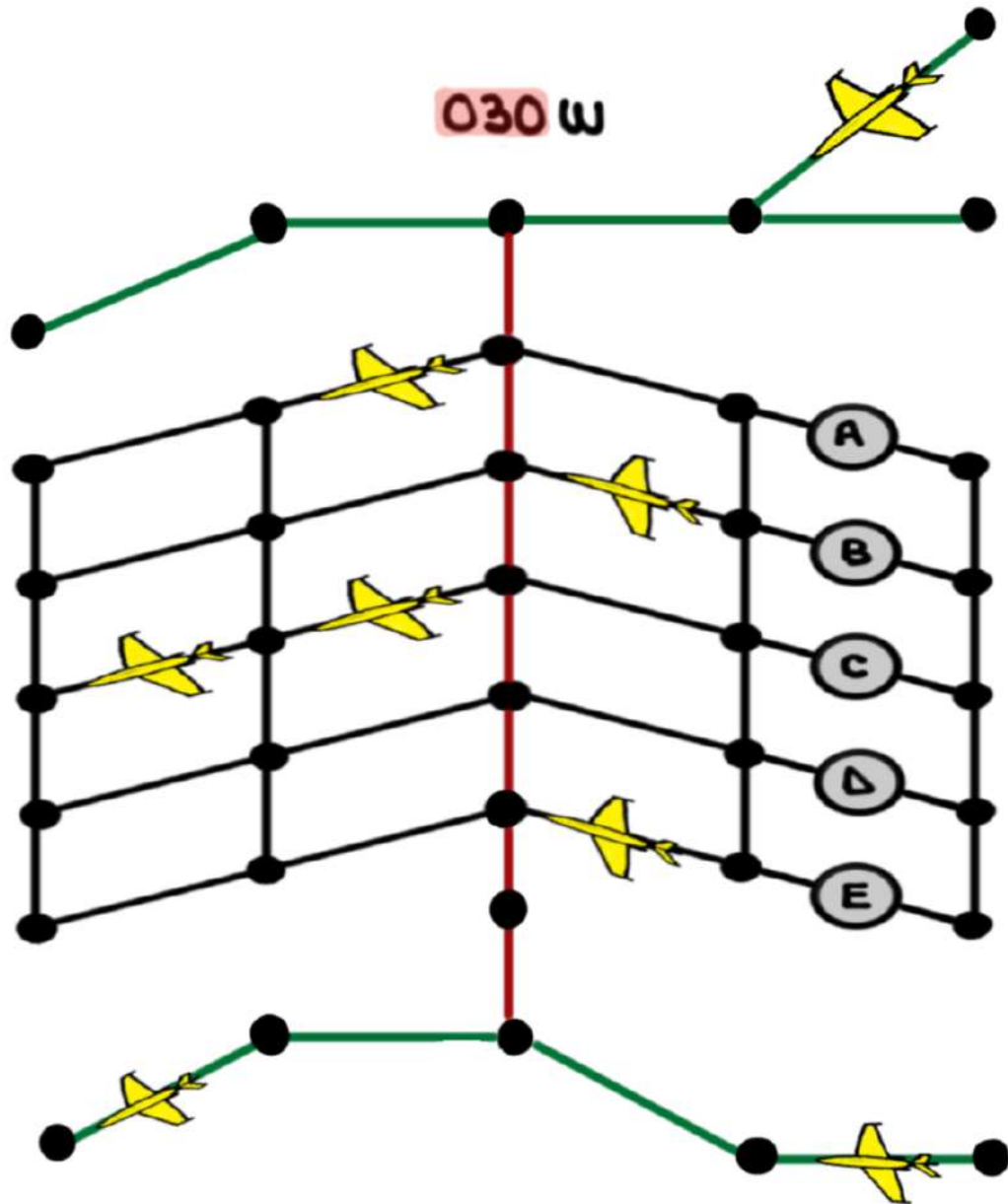

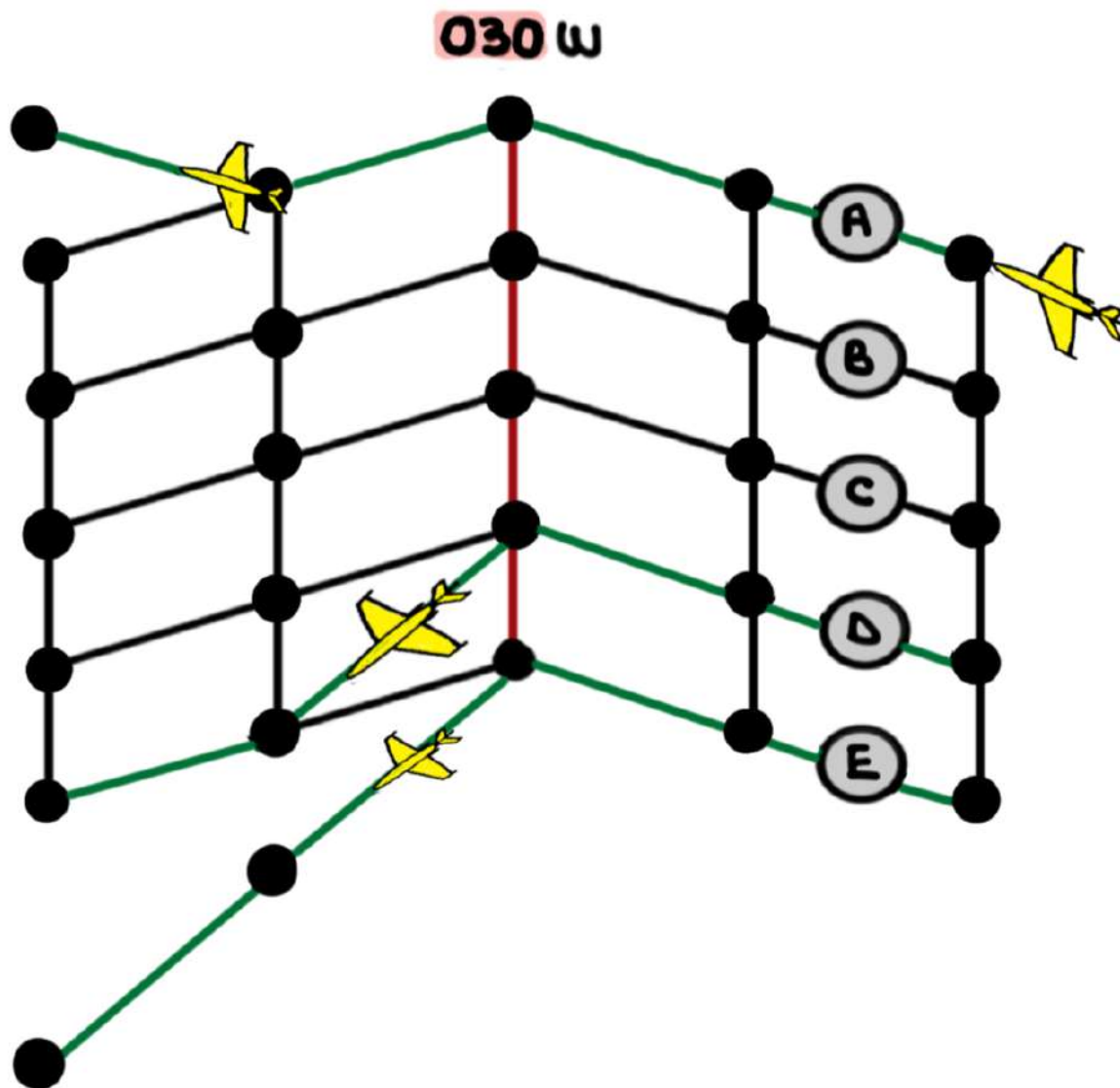

② RANDOM ROUTES CAN ALSO JOIN OR LEAVE AN OUTER TRACK OR CUT ACROSS THE OTS TRACKS

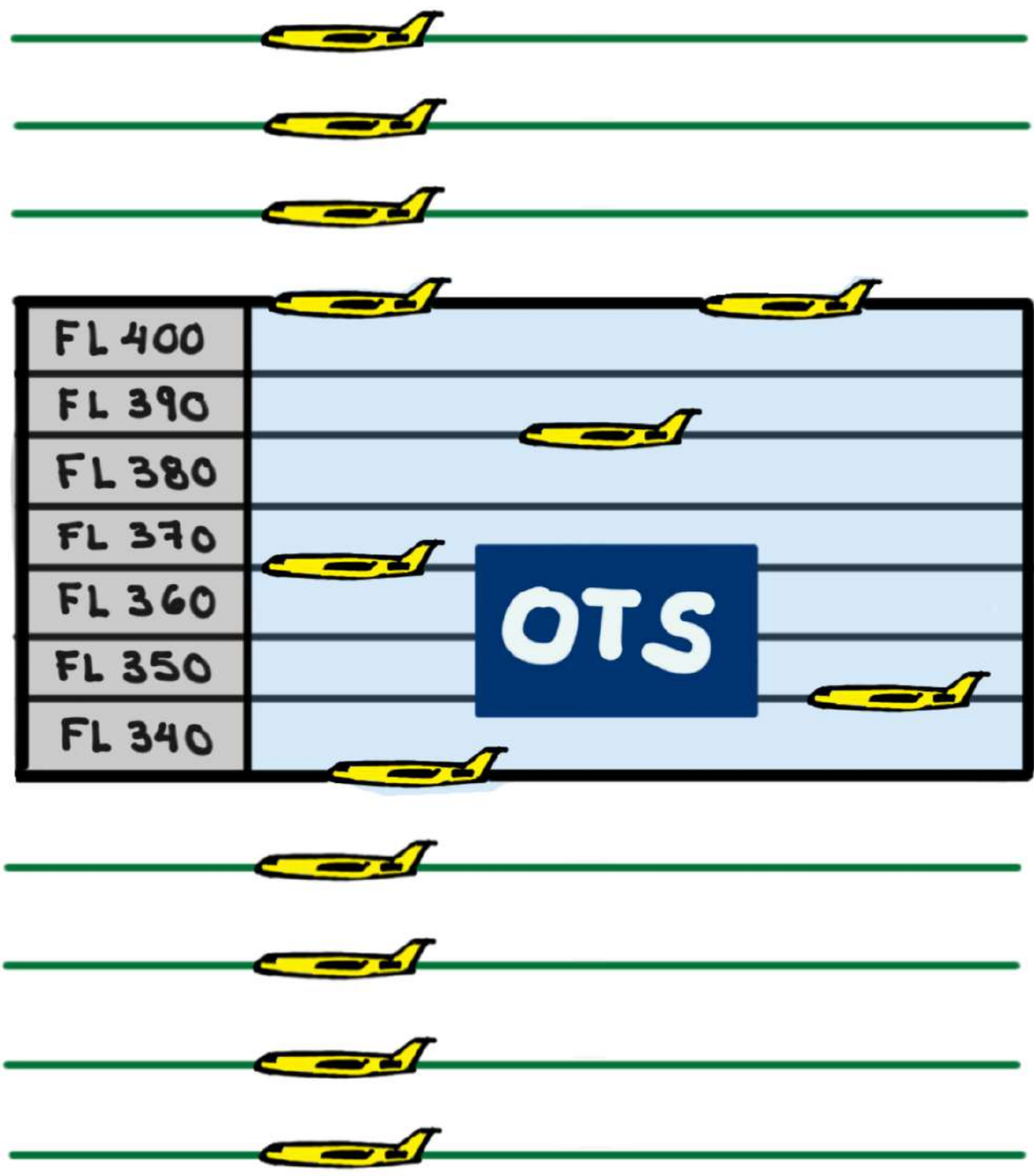

③ RANDOM ROUTES REMAIN ABOVE OR BELOW OTS TRACKS



Equal Time Point (ETP)

- ① AN **ETP** IS A GEOGRAPHICAL LOCATION ALONG THE ROUTE OF flight in which it TAKES THE SAME TIME TO CONTINUE TO THE  **Airport Ahead** AS IT DOES TO RETURN TO THE  **Airport Behind**

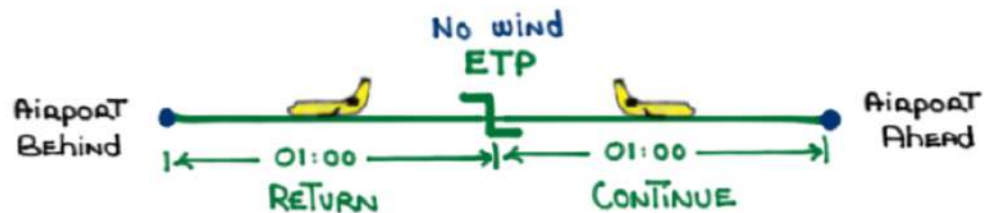

- ② **ETPs** ARE ALSO REFERRED TO AS "**CRITICAL POINT**"

- ③ **ETPs** ARE COMPUTED FOR LONG OVERWATER flights AND ARE BASED ON GROUND SPEED (WIND FACTOR)

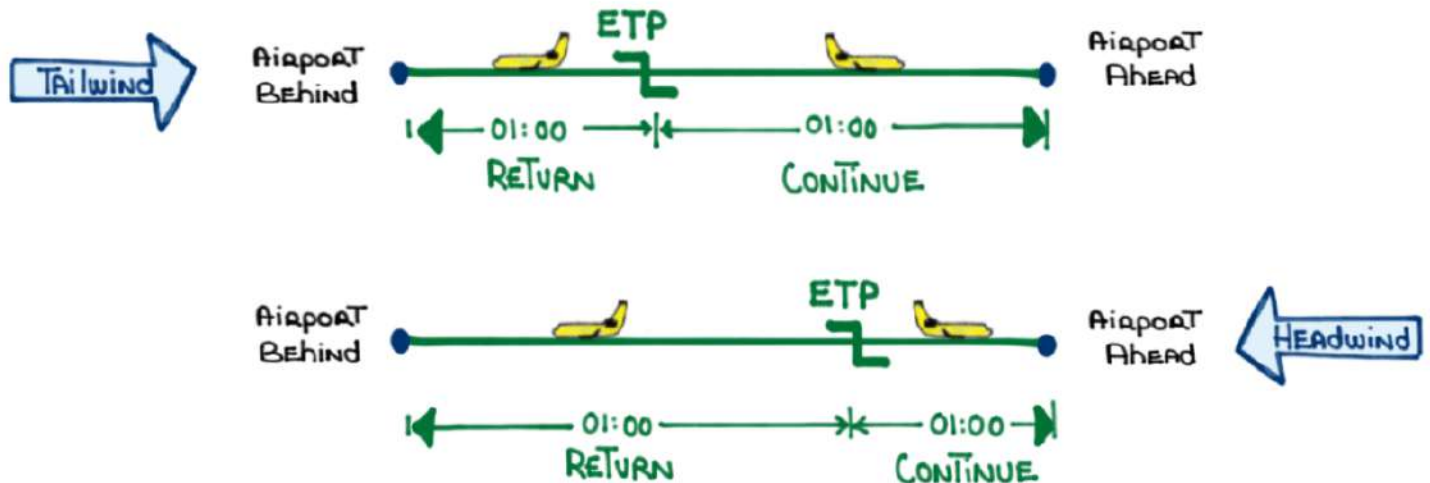

④ ETP formula:

$$\text{GROUND distance To ETP} = \frac{(D)(GS_B)}{GS_A + GS_B} = \text{NM}$$

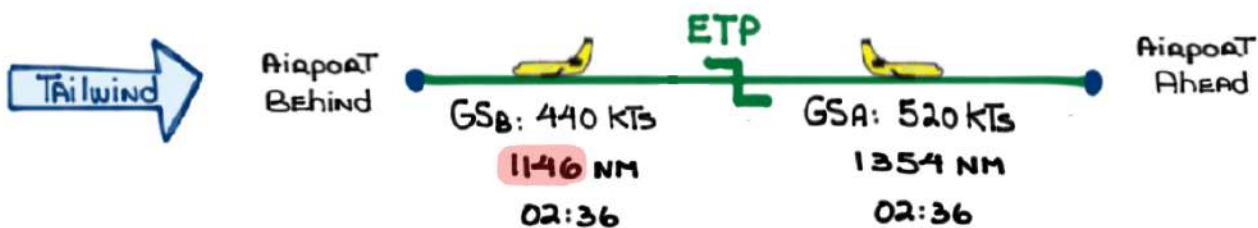
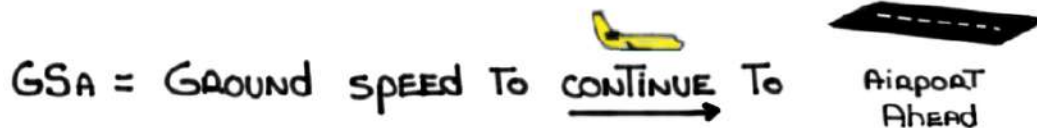

TAS: 480 KCAS

Wind: P40 KTS

Dist: 2500 NM

GSA: 520 KTS

GSB: 440 KTS

$$\text{ETP} = \frac{(2500)(440)}{520 + 440} = 1146 \text{ NM}$$

⑤ In OCEANIC AIRSPACE ETPs ARE COMPUTED ALSO BETWEEN SUITABLE ALTERNATE AIRPORTS

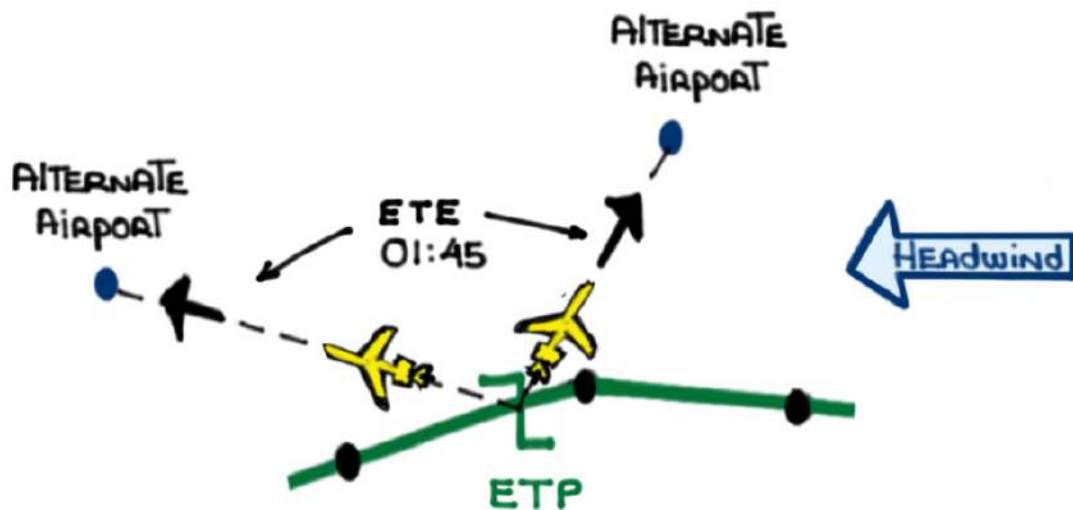

⑥ THERE ARE THREE (3) TYPES OF ETPs :

6.1 LOSS OF ENGINE ETP - (1E INOP)

ENGINE OUT DRIFTDOWN CHARTS

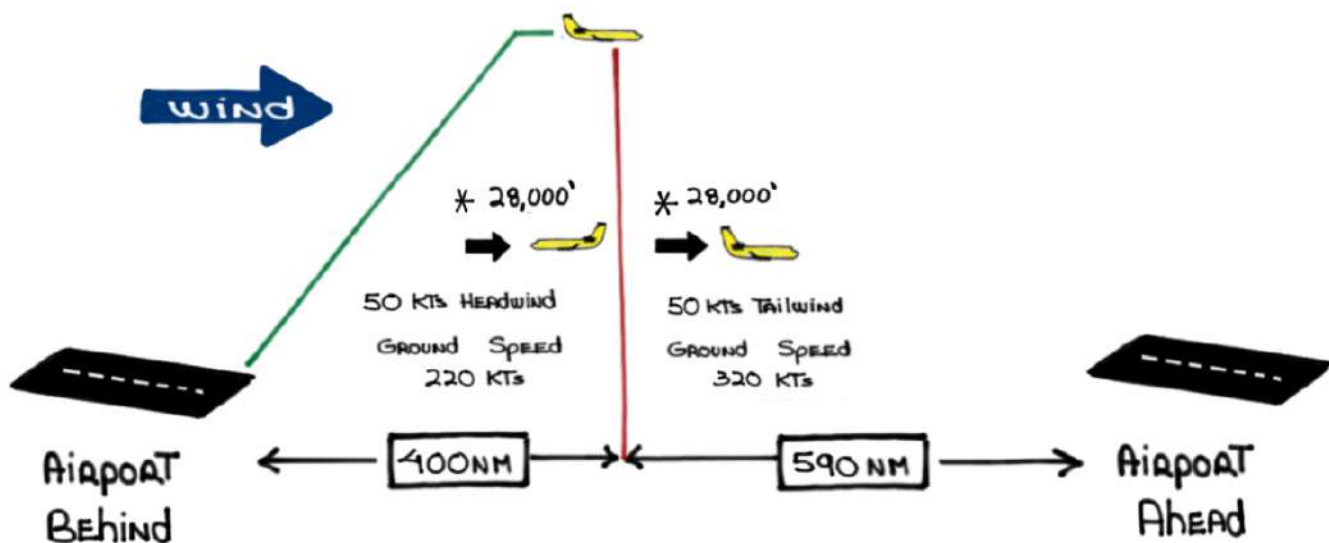

* Final driftdown ALTITUDE AS PER CHART

6.2 LOSS of LEVEL ETP - PRESSURIZATION (DEPRESS)

EMERGENCY DESCENT PROCEDURE

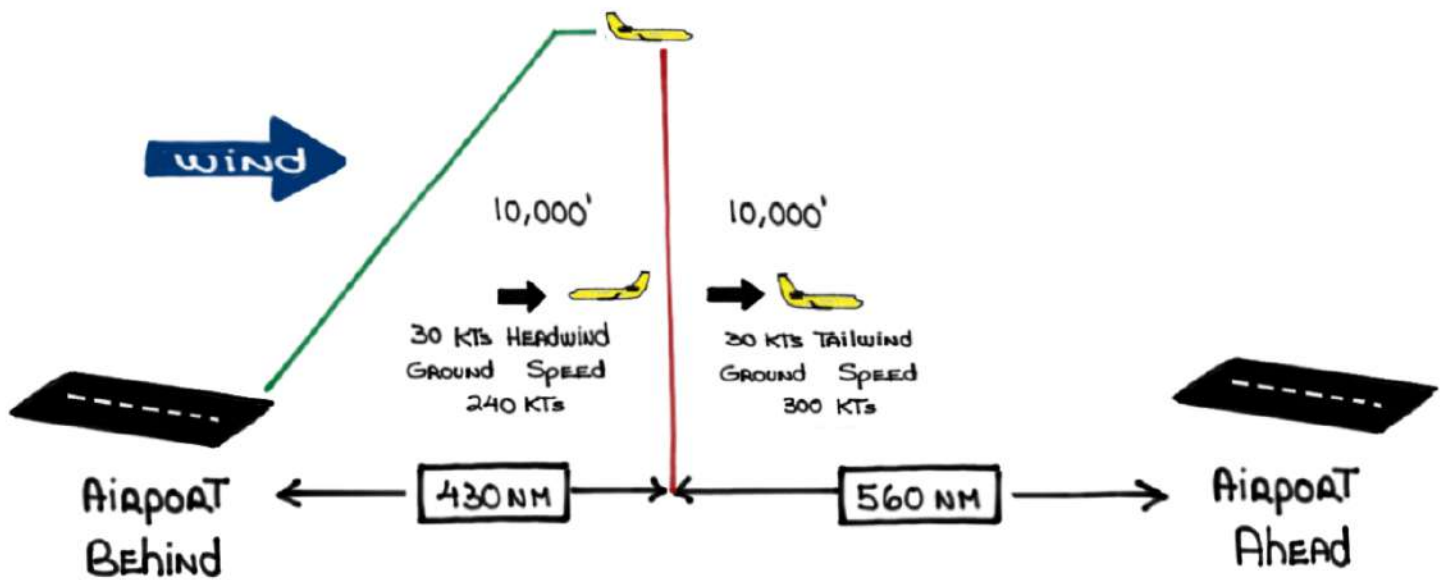

6.3 MAINTAIN LEVEL ETP - MEDICAL (MEDICAL)

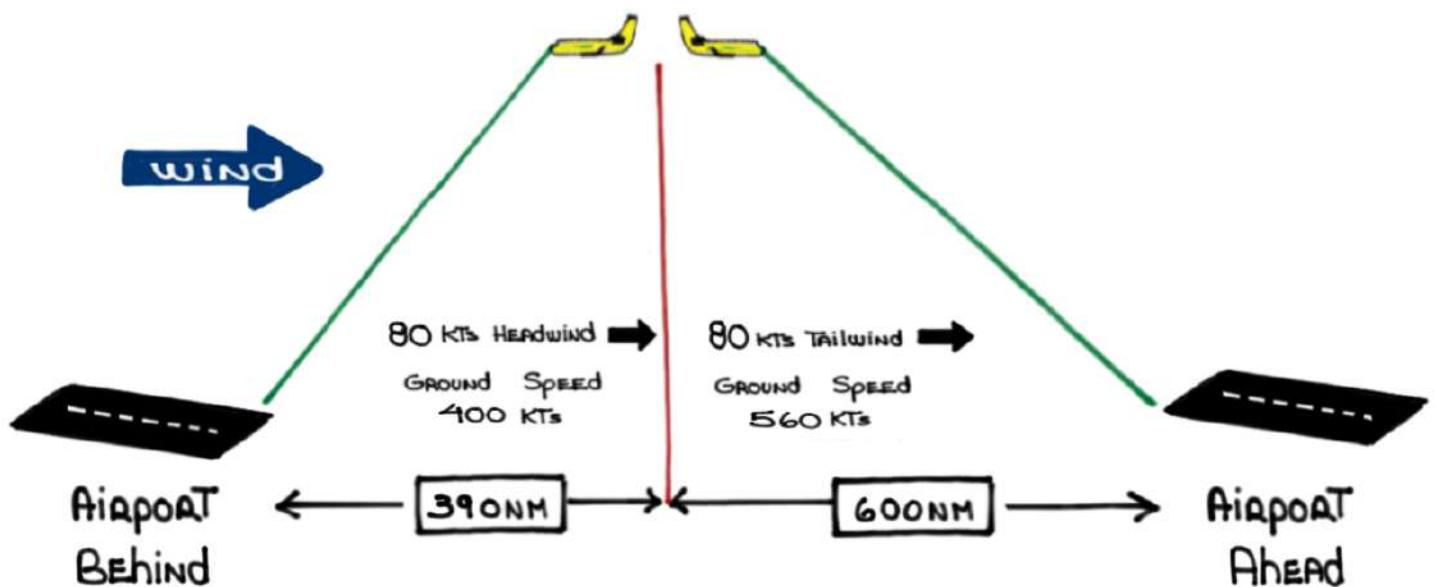

⑦ Plot **ETPs** ON PAPER plotting chart OR digital chart

⑧ DO NOT ENTER **ETPs** INTO FMSs OTHERWISE ADS-C will SEND position reports of NON-EXISTING waypoints TO ATC

ALTERNATE AIRPORTS CAN BE AHEAD OR BEHIND AND LEFT OR RIGHT OF CURRENT POSITION

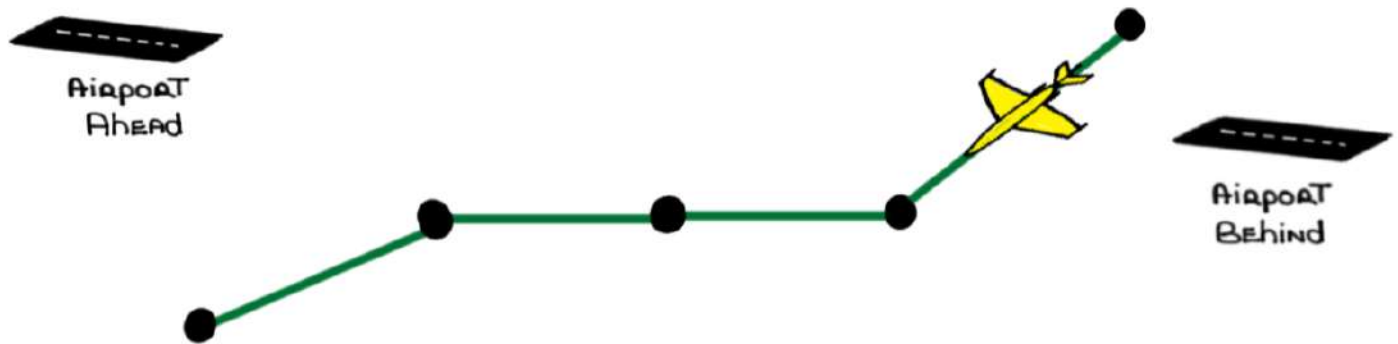

⑨ AS EACH WAYPOINT IS CROSSED MAKE A MENTAL NOTE AND BRIEF THE DIRECTION TO THE RELEVANT ALTERNATE AIRPORT. This could help you decide DIRECTION OF TURN

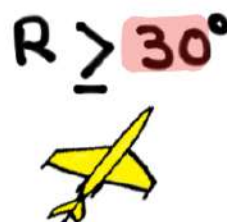
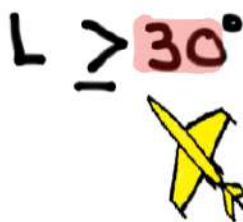

- ⑩ ETP fuel calculations ASSUME A STRAIGHT LINE TO THE ALTERNATE AIRPORT AND DO NOT TAKE INTO ACCOUNT OTS TRACKS, WEATHER DEVIATIONS OR AN INSTRUMENT APPROACH PROCEDURE

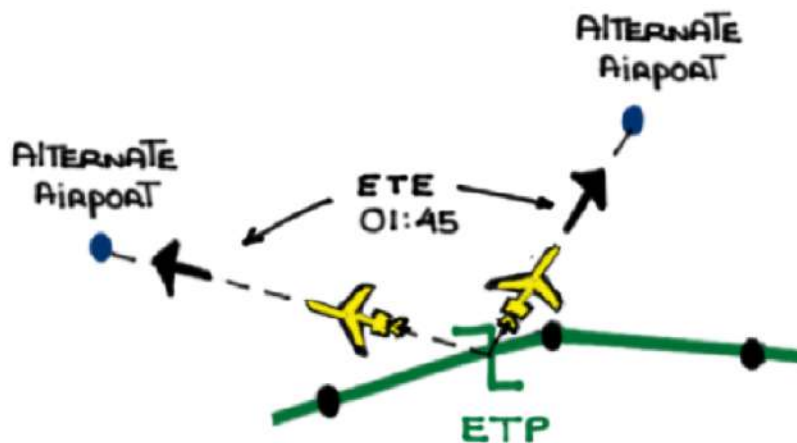

- ⑪ THE QUAD FOUR MANEUVER (DOC 4444) AND A DESCENT BELOW THE OTS TRACKS BEFORE A TURN TO THE ALTERNATE AIRPORT IS MADE WILL REQUIRE MORE FUEL
- ⑫ STARTING THE APU (BACK UP AC POWER) WILL INCREASE FUEL CONSUMPTION

NAT OPS BULLETIN 2018-005

CONTINGENCY PROCEDURES IN NAT HLA AIRSPACE
ASSOCIATED WITH INABILITY TO COMPLY WITH ASSIGNED
CLEARANCE

SPECIAL PROCEDURES

IF A REVISED ATC CLEARANCE CANNOT BE OBTAINED:

① TURN 30° OR MORE AWAY FROM THE TRACK

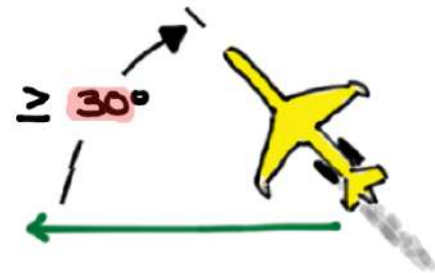
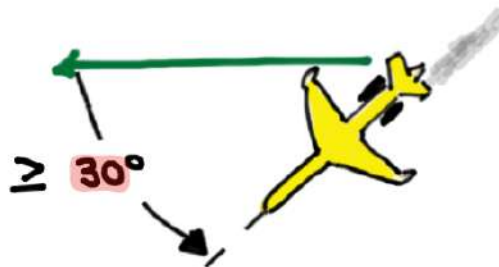

L OR R ?

DIRECTION OF TURN IS BASED ON POSITION OF AIRCRAFT IN
RELATION TO OTHER OTS TRACKS, DIRECTION TO THE
ALTERNATE AIRPORT, SLOP, ETC.

② If **ABLE** To MAINTAIN ASSIGNED FLIGHT LEVEL:

A) ACQUIRE SAME DIRECTION **5 NM** OFFSET TRACK

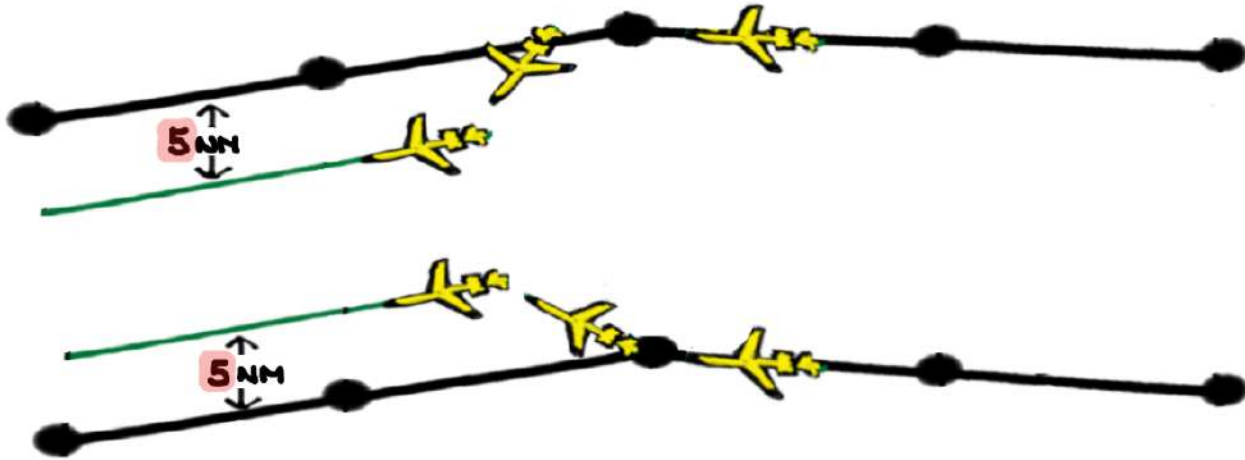

B) ONCE ESTABLISHED ON A **5 NM** OFFSET CLIMB OR DESCEND AS FOLLOWS:

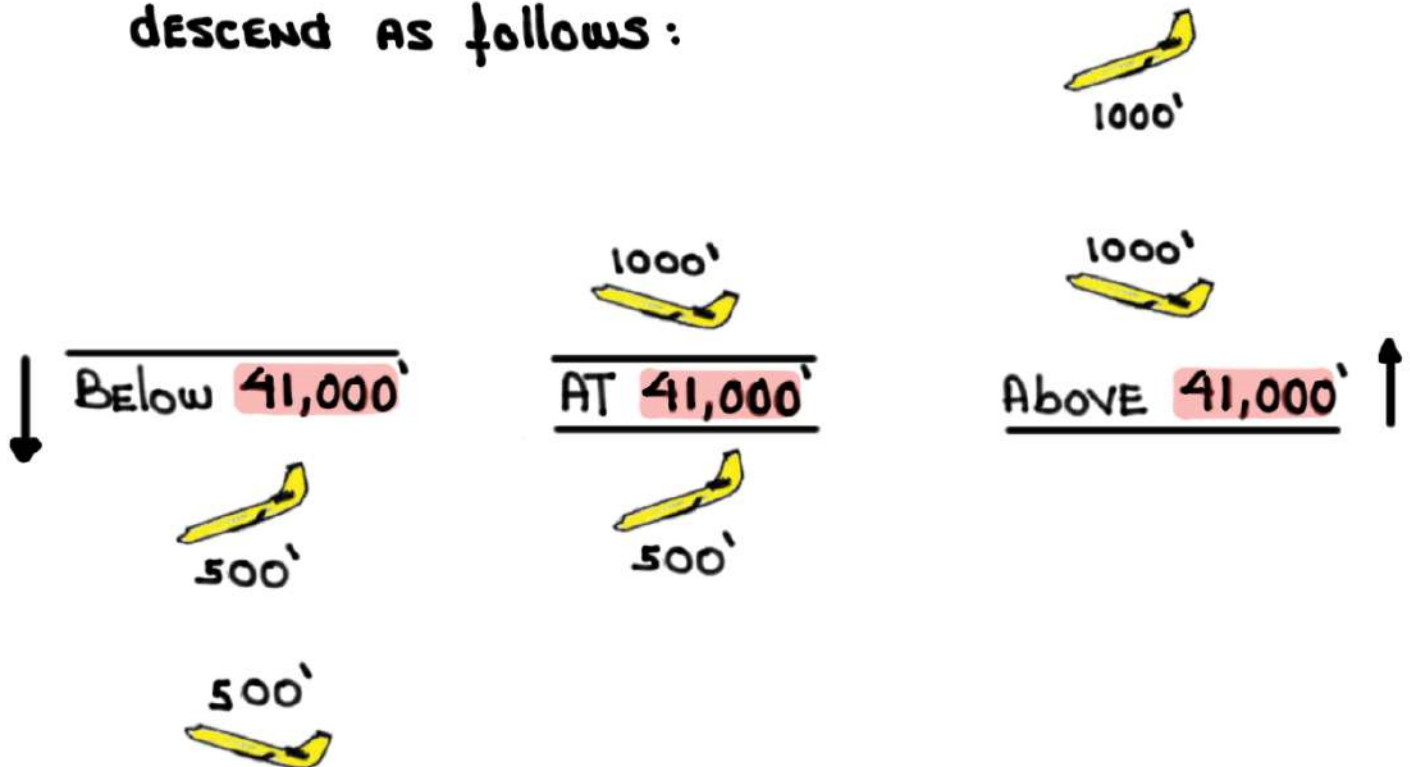

③ If **UNABLE** To MAINTAIN ASSIGNED Flight LEVEL:

A) MINIMIZE RATE of DESCENT To what's OPERATIONALLY FEASIBLE

B) ACQUIRE SAME DIRECTION **5 NM** OFFSET TRACK

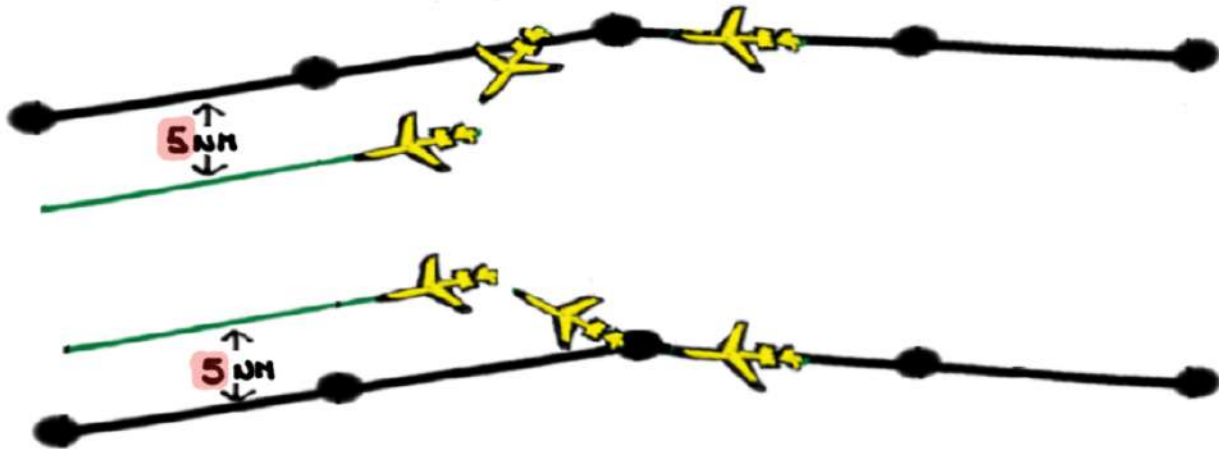

C) DESCEND To **FL290** OR LOWER

D) ONCE below **FL290** ESTABLISH AND MAINTAIN A VERTICAL OFFSET of **500'** FROM NORMAL LEVELS AND PROCEED AS REQUIRED UNTIL AN ATC CLEARANCE IS RECEIVED

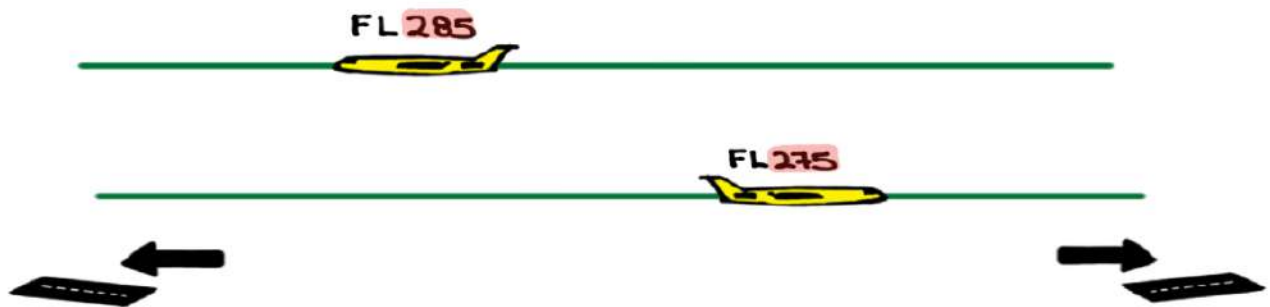

E) ESTABLISH COMMUNICATION WITH ATC AND NEARBY AIRCRAFT ON 121.5 AND 123.45 MHz

F) TURN ON ALL EXTERNAL LIGHTS

G) ENSURE TRANSPONDER IS ON

DEVIATIONS AROUND SEVERE WEATHER

REVISED ATC CLEARANCE NOT POSSIBLE:

- ① If ≤ 5 NM deviation - MAINTAIN ASSIGNED FLIGHT LEVEL

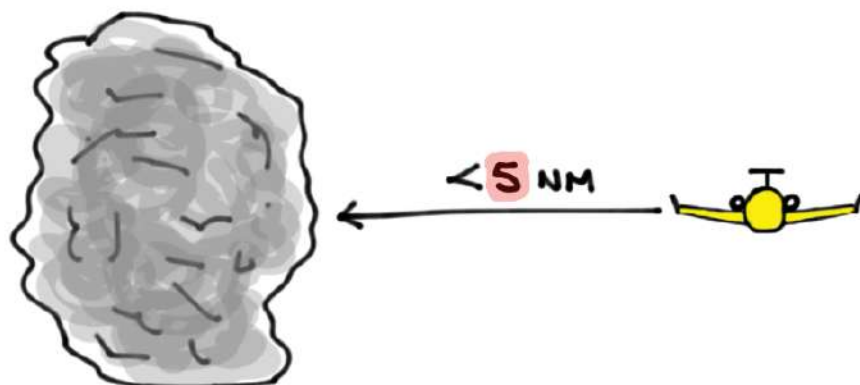

- ② If > 5 NM deviation - ADJUST ALTITUDE AS FOLLOWS:

"TURNING NORTH DESCEND. TURNING SOUTH CLIMB"

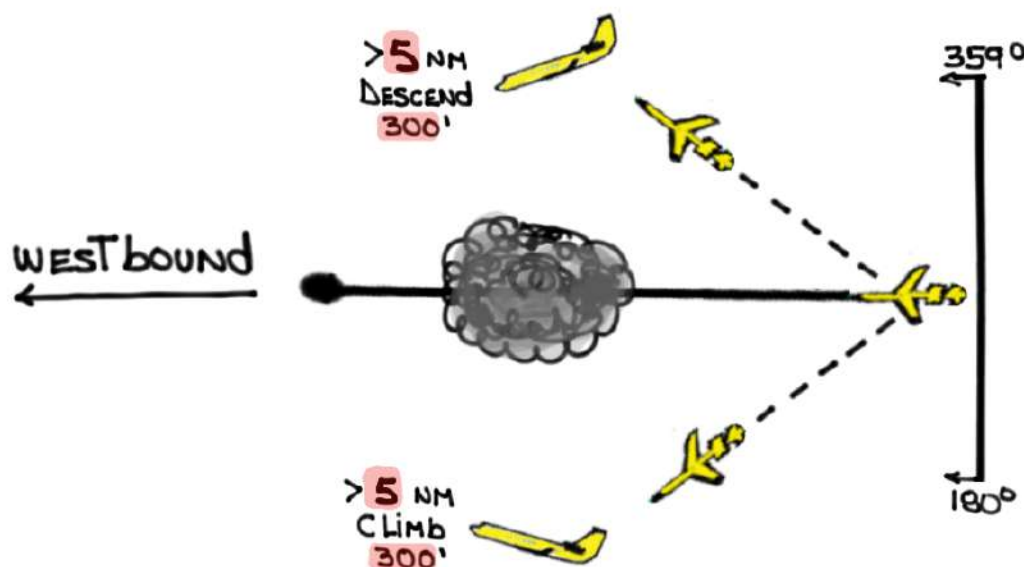

"TURNING NORTH descend. TURNING SOUTH climb"

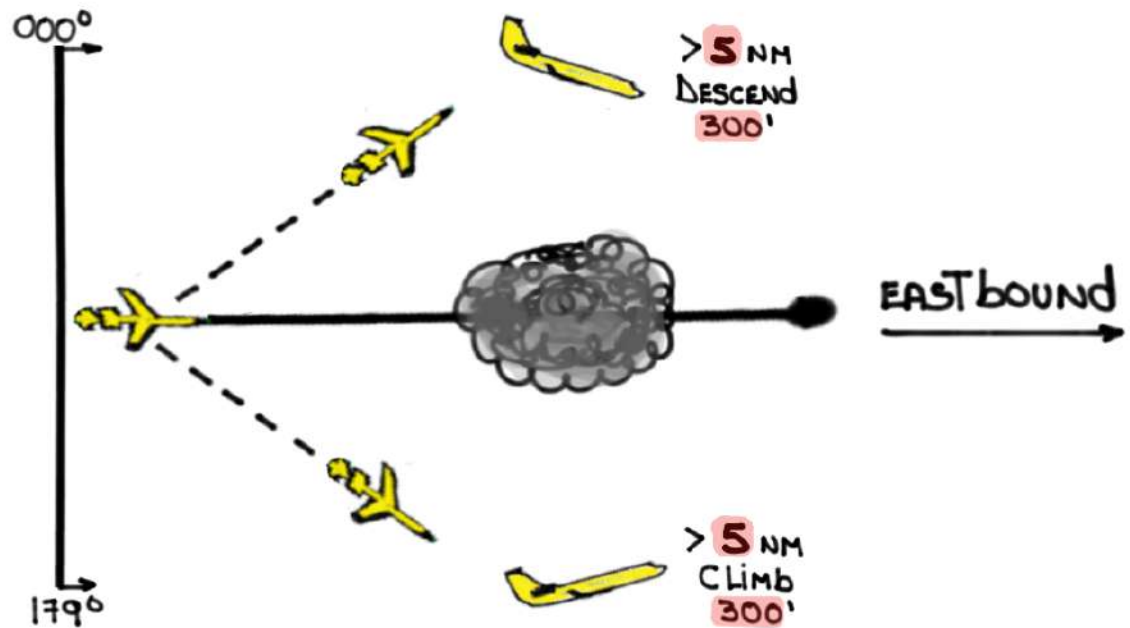

SAND = South ASCEND North DESCEND

- ③ ESTABLISH COMMUNICATION WITH ATC AND NEARBY AIRCRAFT ON 121.5 AND 123.45 MHz
- ④ TURN ON ALL EXTERNAL LIGHTS
- ⑤ ENSURE TRANSPONDER IS ON

WAKE TURBULENCE

① STRATEGIC LATERAL OFFSET PROCEDURES (SLOP)

- STANDARD OPERATING PROCEDURE THROUGHOUT NAT REGION
- SLOP AND MICRO-SLOP

② SLOP:

- CLEARED TRACK CENTERLINE
- 1.0 NM RIGHT OF CENTERLINE
- 2.0 NM RIGHT OF CENTERLINE

③ MICRO-SLOP:

- 1/10TH NM INCREMENTS UP TO 2.0 NM RIGHT OF CENTERLINE

④ DO NOT SLOP ~~LEFT~~ OF CENTERLINE

⑤ NO ATC APPROVAL IS REQUIRED

⑥ COORDINATION WITH PRECEDING AIRCRAFT, if REQUIRED,
ON 123.45 MHz

⑦ A WAKE TURBULENCE ENCOUNTER MUST BE REPORTED

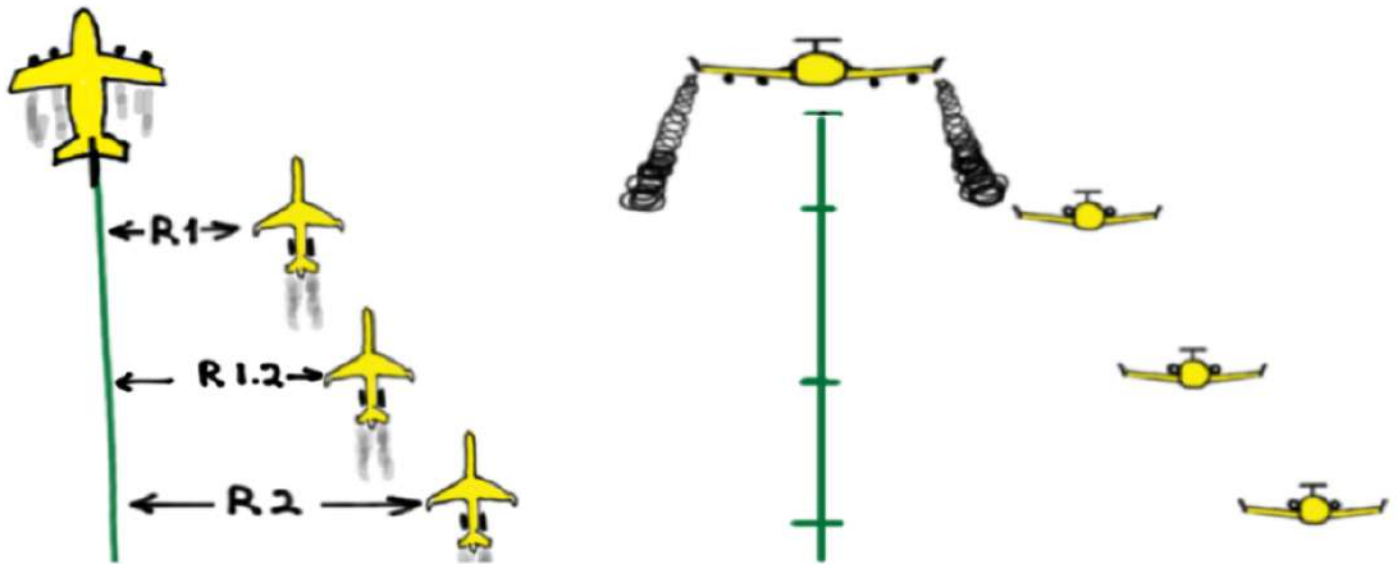

PART II

DRIFTDOWN

WHEN ON OR ABOVE THE OTS AN OFFSET AND DRIFTDOWN ARE REQUIRED WHEN AN ENGINE FAILS AT AN ALTITUDE ABOVE THE ONE ENGINE INOPERATIVE (OEI) SERVICE CEILING AND THE DIVERSION AIRPORT IS AHEAD

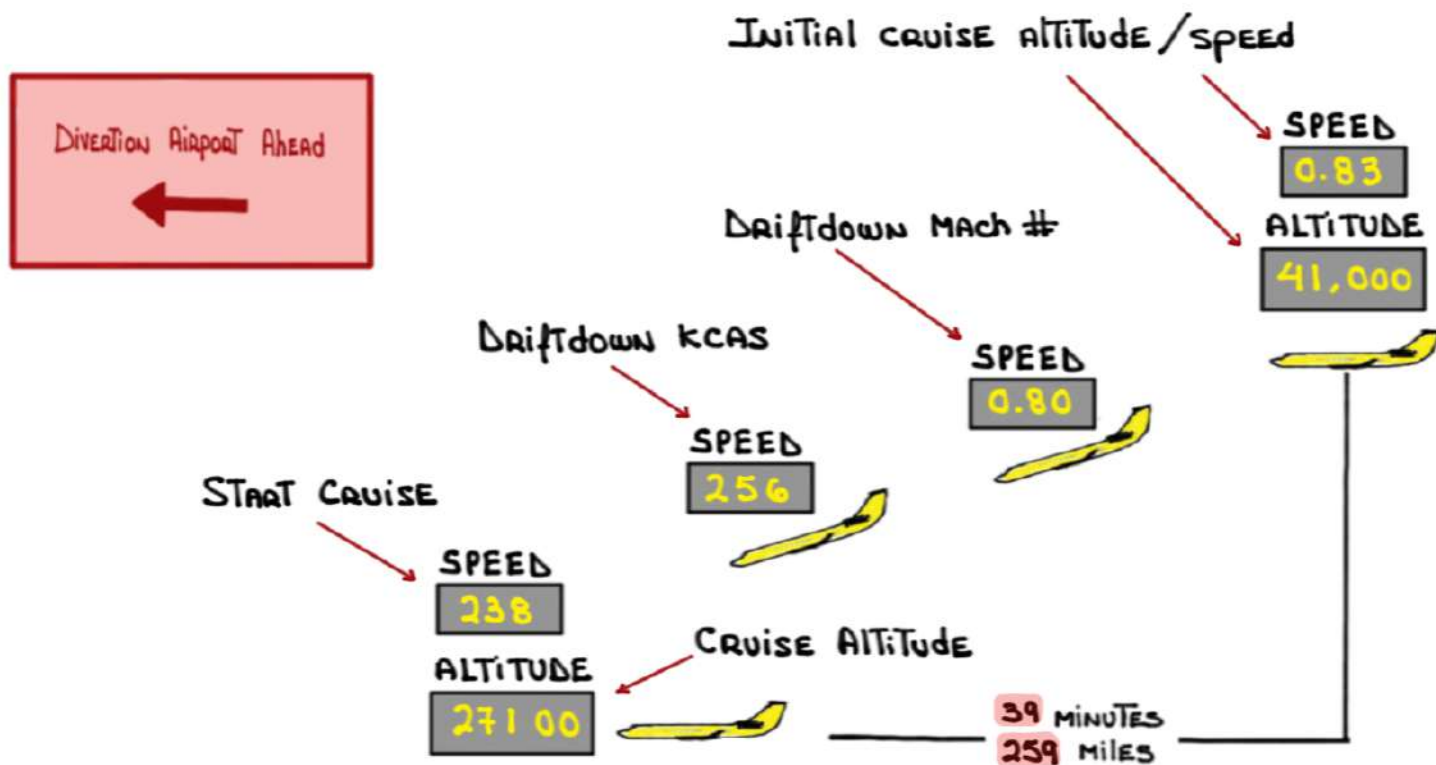

EXPEDITED DESCENT

AN OFFSET AND EXPEDITED DESCENT ARE REQUIRED WHEN AN ENGINE FAILS WHILE ON OR ABOVE THE OTS AND THE DIVERSION AIRPORT IS BEHIND

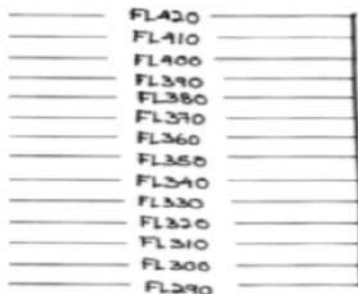

SPEED BRAKE EXTENDED

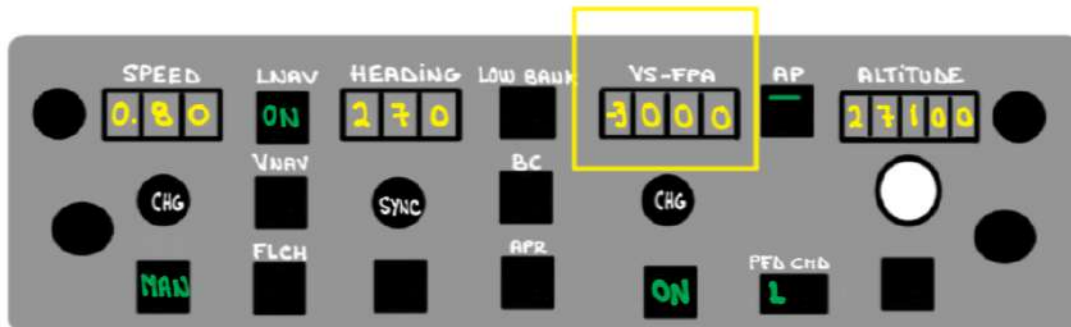
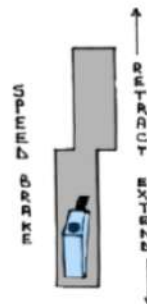

PART III

SCENARIO #1

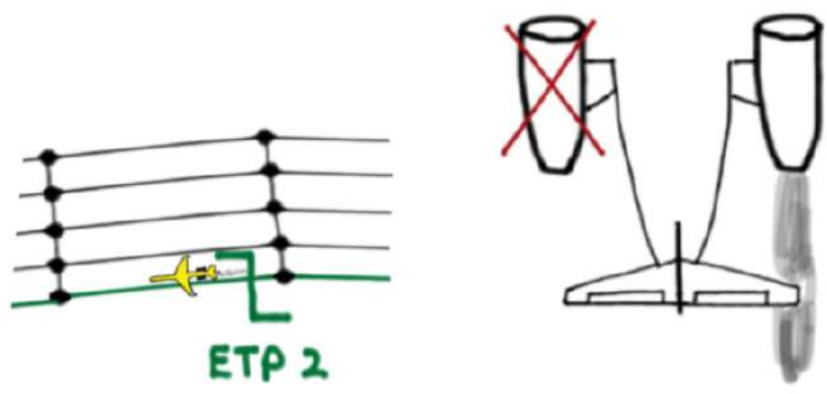
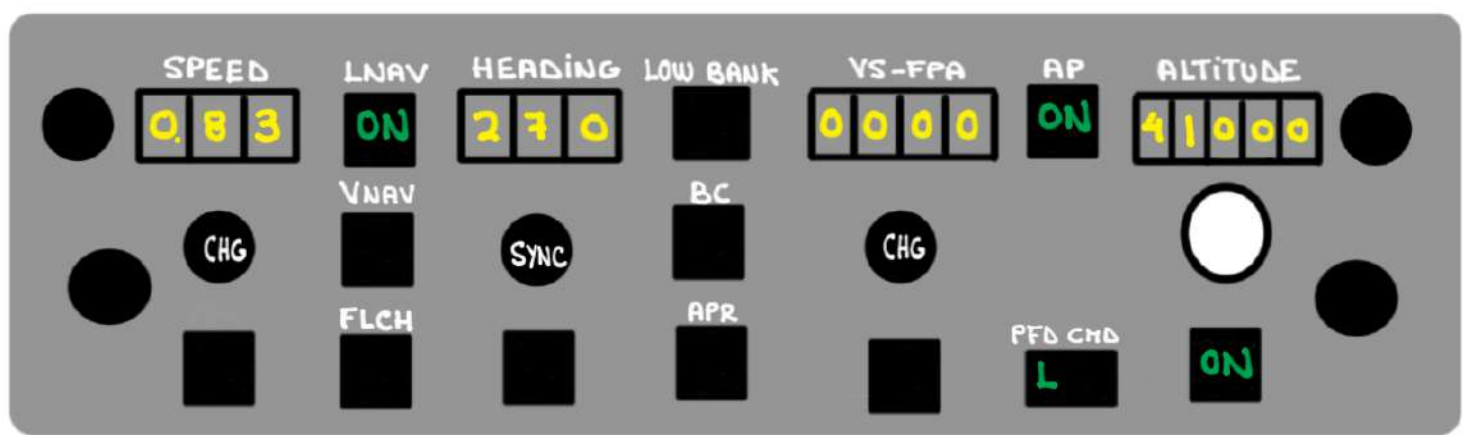

- NORTH ATLANTIC / RANDOM ROUTE / WESTBOUND
- FL410 , MO.83 , 66,000 lbs / ISA
- SLOP R2 , LEFT ENGINE FLAMES OUT AFTER ETP2

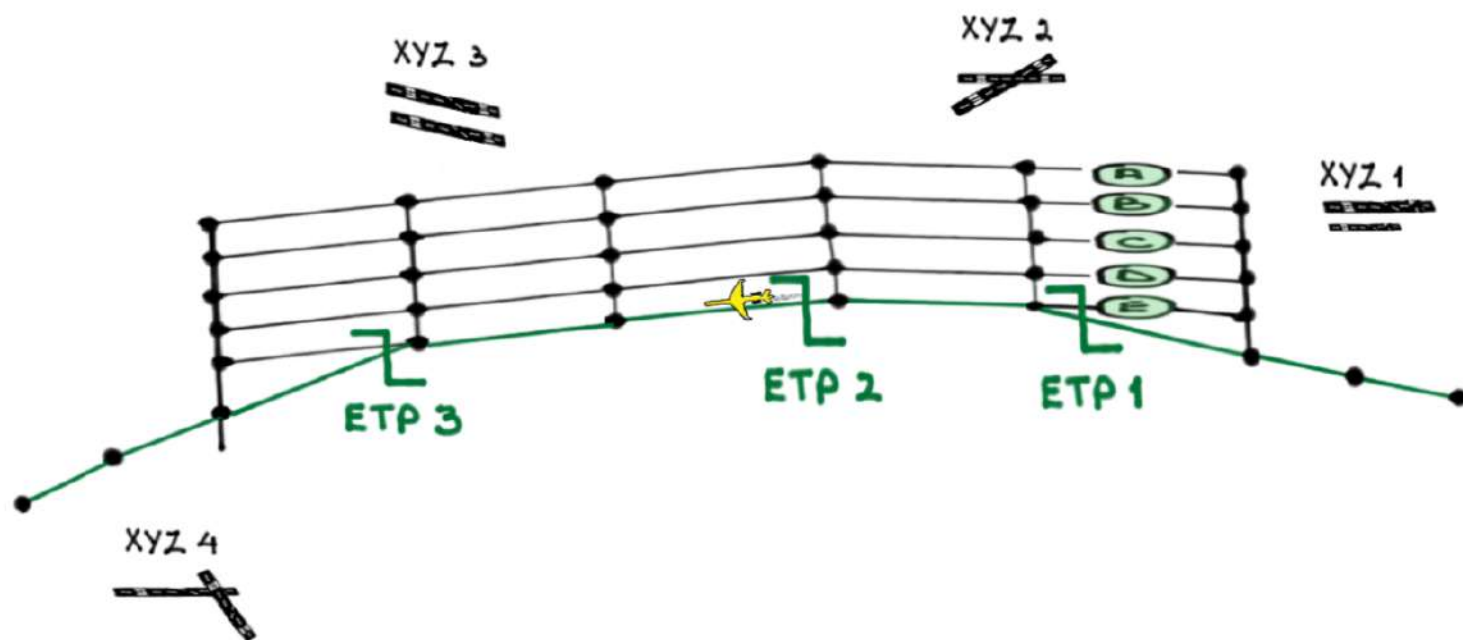

SCENARIO'S OBJECTIVE:

- ① REVIEW RELEVANT DRIFTDOWN PROCEDURES
- ② AVIATE, NAVIGATE, AND COMMUNICATE
- ③ ASSESS HOW AN ENGINE FAILURE AFFECTS OTHER SYSTEMS

PART IV

DRIFTDOWN PROCEDURES

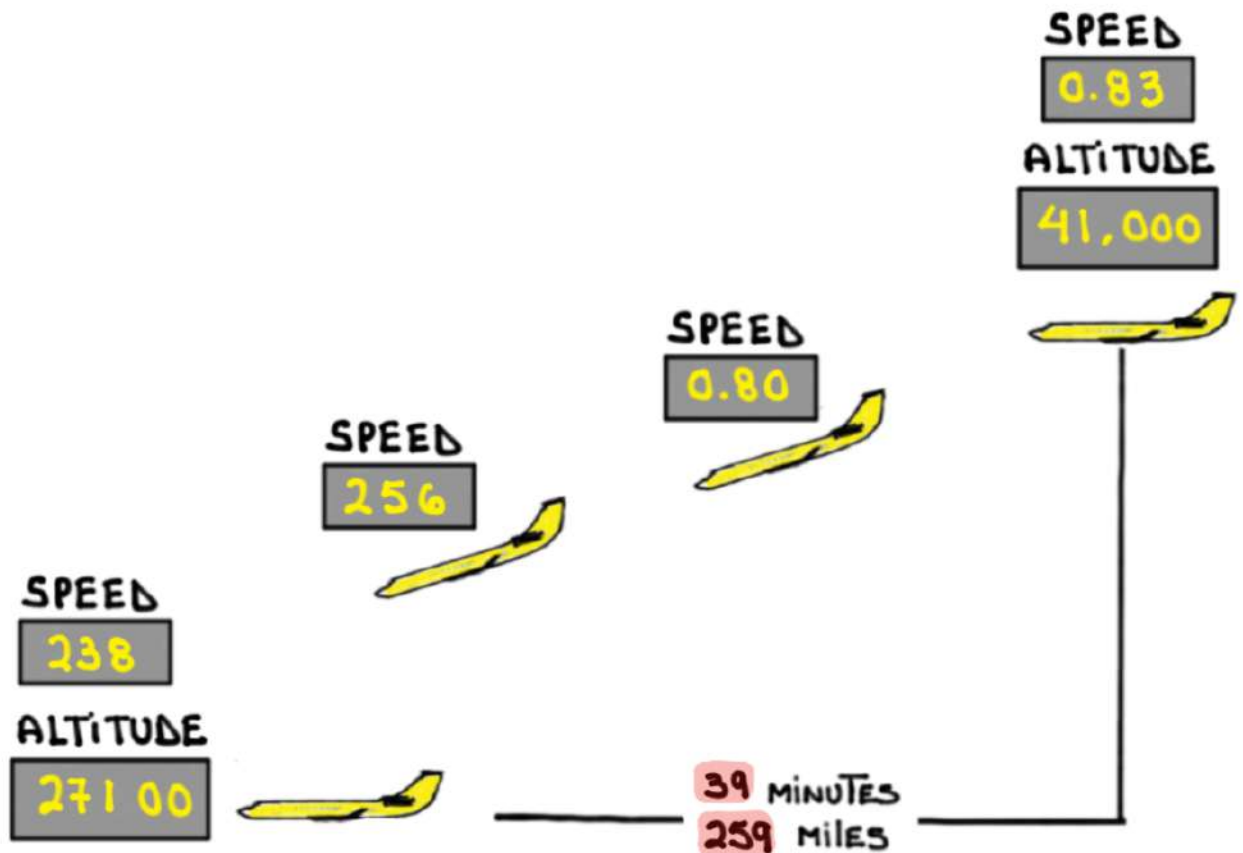

AOM, CHAPTER 2B - PLANEVIEW PILOT'S MANUAL

2B-26-140 S.E. RANGE

The G450's MCDU calculates and displays the following single engine range information:

- RANGE AND TIME TO FUEL RESERVES
- RANGE AND TIME TO ZERO FUEL

Calculated at the optimum LRC altitude and speed when operating with one engine inoperative (OEI)

1) **PERF**

2) LSK 5R - S.E. RANGE

```
S.E. RANGE 1/1
CRZ ALTITUDE   CRZ SPEED
FL350          207
RANGE <RES FUEL> ETE
660           02+07
RANGE <ZERO FUEL> ETE
1283          03+57
```

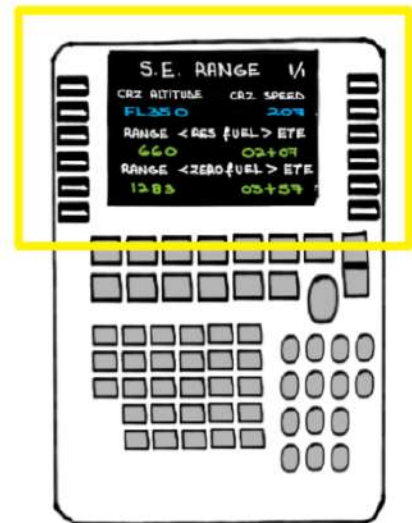

AOM, CHAPTER 11 - PERFORMANCE

ATA 11-05-00 ENGINE OUT DRIFTDOWN

DRIFTDOWN PROCEDURE:

TO ATTAIN THE DRIFTDOWN PERFORMANCE SHOWN, THE RECOMMENDED DRIFTDOWN PROCEDURE DESCRIBED BELOW MUST BE FOLLOWED:

- (A) AT THE FAILURE OF ONE ENGINE, MAXIMUM CONTINUOUS THRUST IS SET AND HELD ON THE OPERATING ENGINE DURING ANY DECELERATION IF REQUIRED TO REDUCE THE SPEED TO THE ENTRY DESCENT MACH. ANY DECELERATION SHOULD BE PERFORMED AT THE INITIAL CRUISE ALTITUDE BEFORE THE START OF DESCENT
- (B) THE DESCENT MACH NUMBER SHOULD BE MAINTAINED UNTIL THE CALIBRATED SPEED IS INTERCEPTED. THE CALIBRATED SPEED IS THEN HELD DOWN TO THE FINAL DRIFTDOWN ALTITUDE (IDENTIFIED AS CRUISE ALTITUDE)

ENGINE OUT DRIFTDOWN

ISA

Initial AIT (FT) OAT (°C)		Initial Driftdown Weight - 1000 LB			
				66	
				↓	
41,000 -56	DESCENT MACH/KCAS TIME FUEL DIST START CRUISE CRUISE ALTITUDE	→		0.80/256 39 1770 259 238 27,100	

- (c) AT THE final driftdown altitude, a 200 FPM RATE of climb capability will be possible AT MCT AT THE "START CRUISE" calibrated AIRSPEED shown (LRC speed)
- (d) MODERATE THRUST REDUCTIONS ARE REQUIRED AT THE "CRUISE ALTITUDE" TO STABILIZE AT THE "START CRUISE" calibrated AIRSPEED

Driftdown Profile

Engine Out Driftdown ISA

Initial Alt (FT)	Initial Driftdown Weight - 1000 LB	ISA	
		Initial Alt (FT)	Initial Driftdown Weight - 1000 LB
	66		
41,000		0.80/256	
-56		1710	
		238	
		27,100	

DSCNT MACH/KCAS
 TIME
 FUEL
 DIST
 START CRUISE
 CRUISE ALTITUDE

0.80/256
 39
 1710
 238
 27,100

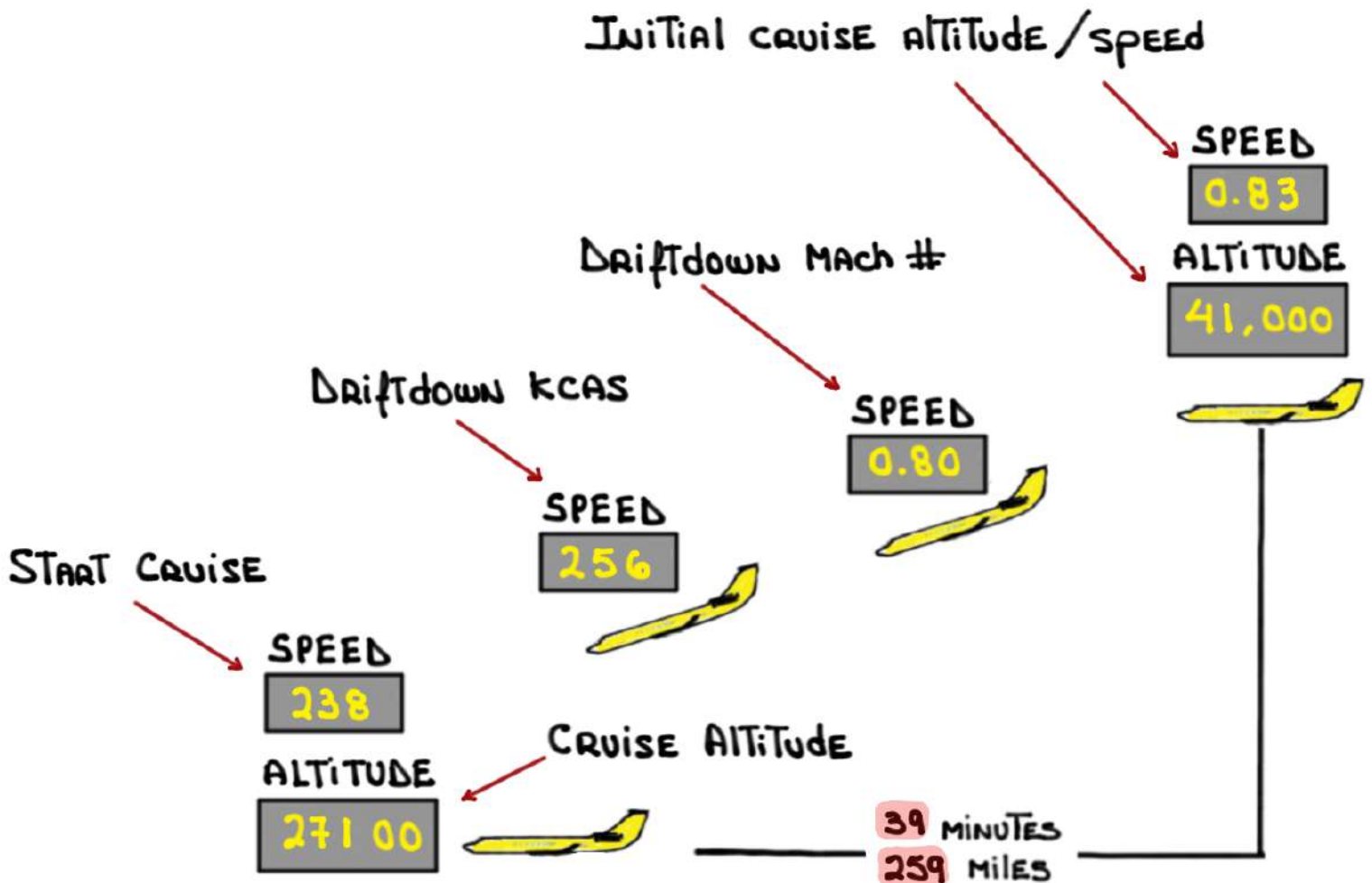

① Fly The AIRCRAFT:



L ENGINE FAIL



- The autopilot will remain ENGAGED
- The autothrottle will disconnect automatically
- There will be some yaw as the left engine rolls back
- Regain and maintain directional control
- Set Maximum Continuous Thrust (MCT) on operating engine

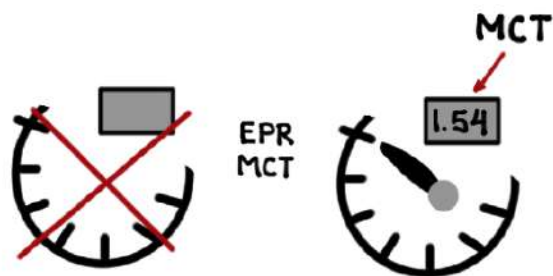
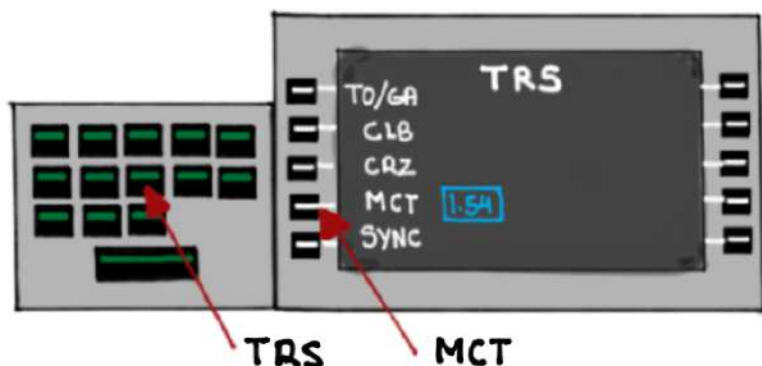

② TURN AWAY FROM THE TRACK:

- Sync HDG, SELECT HDG, AND ROTATE HDG KNOB $\geq 30^\circ$ TO THE RIGHT (direction to XYZ3)

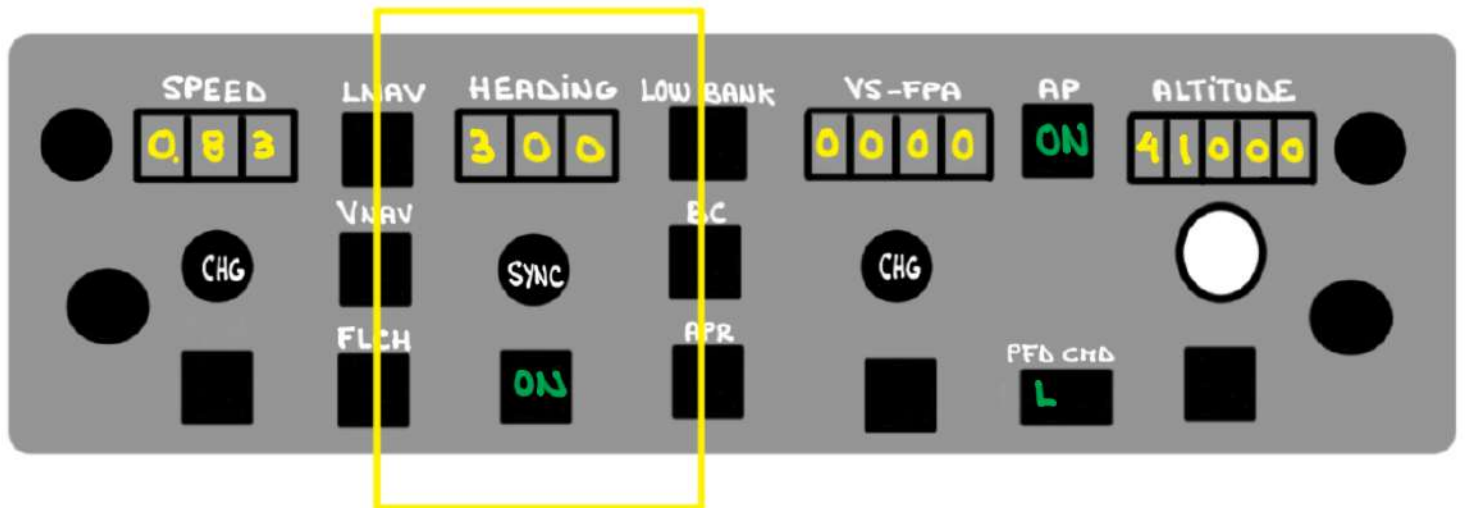

XYZ3

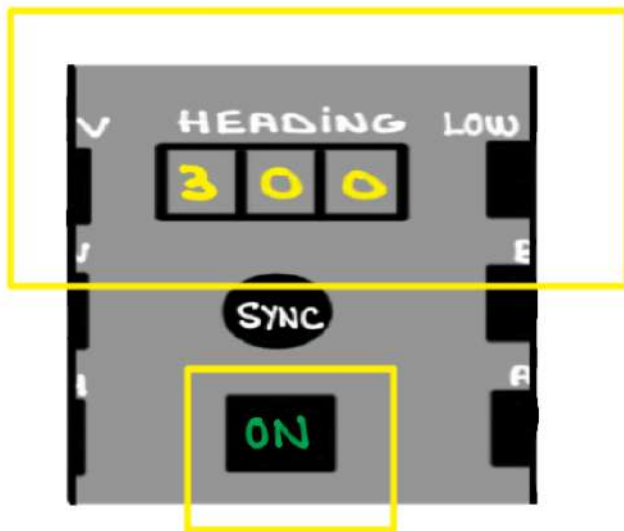

③ CREATE R5.0 offset:

1) **PROG**

2) **NEXT NEXT**

3) SCRATCH PAD: **R5**

4) **—** LSK 1R

5) SELECT **—** LNAV ON GUIDANCE PANEL

6) CONFIRM **FMS** IS CAPTURED/ANNUNCIATED

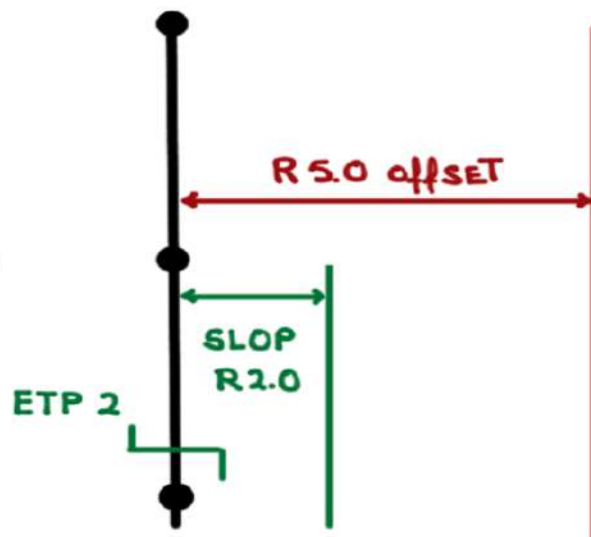
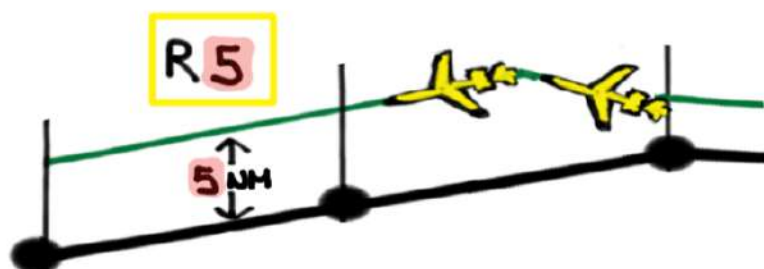
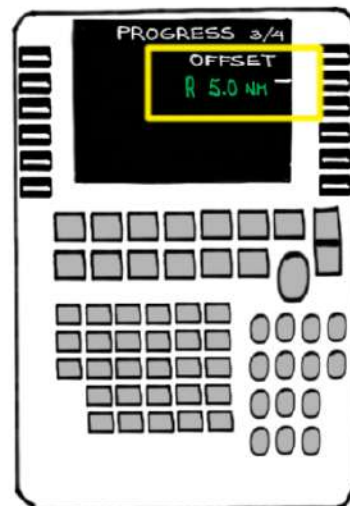

④ CALL FOR DRIFTDOWN CHART

AFM OPERATING MANUAL PERFORMANCE

ENGINE OUT DRIFTDOWN CHARTS

- 1) **PERF**
- 2) **—** LSK 1L
- 3) **PREV**

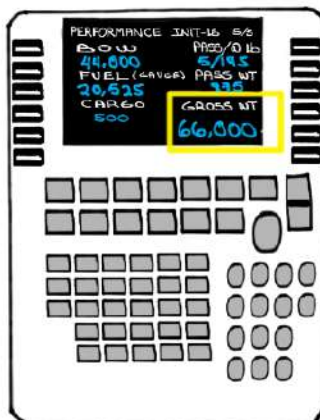

PERFORMANCE INIT-16 5/8
 BOW 44,000 PASS/O 1b 5/195
 FUEL (GAUGE) 20,525 PASS WT 935
 CARGO 500 GROSS WT 66,000

ENGINE OUT DRIFTDOWN

ISA

Initial ALT (FT) ORT (°C)	Initial Driftdown Weight - 1000 LB		
			66
41,000 -56	DSCNT MACH/KCAS TIME FUEL DIST START CRUISE CRUISE ALTITUDE		0.80/256 39 1770 259 238 27,100

DSCNT MACH/KCAS
 TIME
 FUEL
 DIST
 START CRUISE
 CRUISE ALTITUDE

0.80/256
 39
 1770
 259
 238
 27,100

⑤ DESCEND below The OTS (<FL290):

- SET Single ENGINE CRUISE ALTITUDE
- SELECT **MAN** AND SET DESCENT MACH NUMBER
- SELECT **FLCH ON**

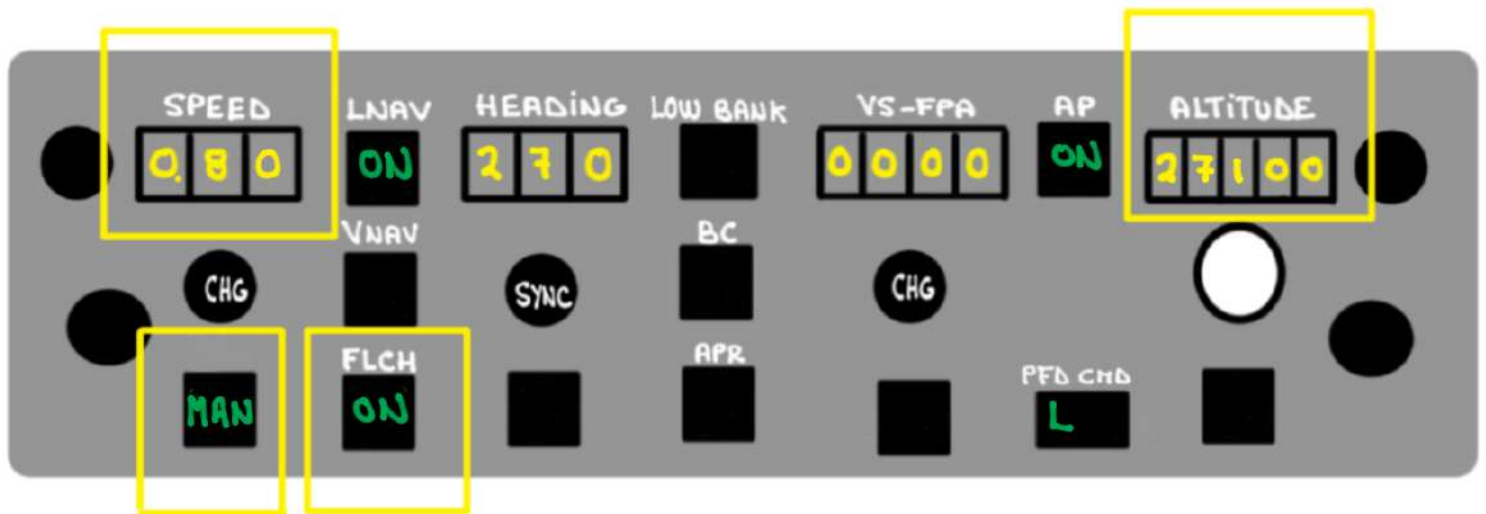



NOTES:

- DECELERATION FROM **M0.83** TO **M0.80** SHOULD BE AT THE INITIAL CRUISE ALTITUDE OF **41,000'**
- EXPECT DECELERATION RATE TO INCREASE WHILE TURNING AWAY FROM THE TRACK

- Do NOT allow speed to decrease below M0.80
- In order to maintain M0.80 the descent will likely commence before being established on a same direction 5 NM lateral offset
- AUTOTRATTLE MUST REMAIN OFF TO MAINTAIN THE DRIFTDOWN PROFILE
- SPEED CONTROL MODE:

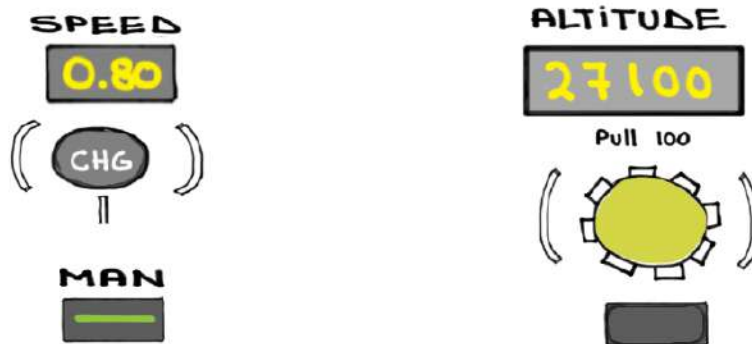
THE AFM AND AOM DO NOT PROVIDE GUIDANCE AS TO WHICH VERTICAL MODE TO USE



If **FLCH**  RESULTS IN SPEED OSCILLATIONS DURING THE DRIFTDOWN, AS THE AFCS CORRECTS FOR SPEED DEVIATIONS, CONSIDER USING **VS/FPA**  INSTEAD

⑥ COMMUNICATE - ATC:

DATALINK (CPDLC/ADS-C)

- 1) **NAV**
- 2) **—** LSK 1R - ATC
- 3) ATC Logon/STATUS 1/2
- 4) **—** LSK 6L - ATC INDEX
- 5) **—** LSK 1L - **EMERGENCY**
- 6) **—** LSK 1L - **MAYDAY**
- 7) POPULATE EMERGENCY REPORT
- 8) VERIFY IT AND SEND IT

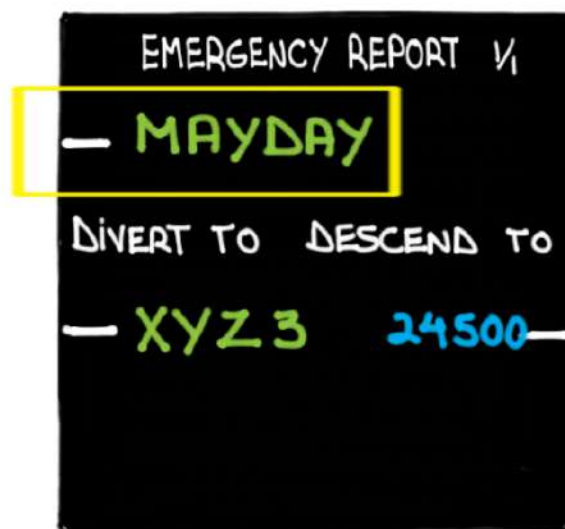
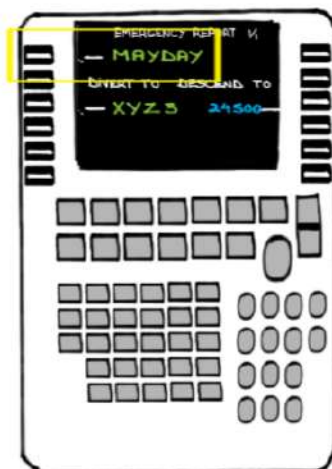

⑦ OTHER TRAFFIC:

1) BROADCAST YOUR SITUATION, POSITION AND INTENTIONS ON 121.5 AND 123.45 MHz

2) TURN ON ALL EXTERNAL LIGHTS *

* LANDING LIGHTS DO NOT FUNCTION ABOVE 18,000'

* PULSE LIGHTS FUNCTION WITHOUT ALTITUDE RESTRICTIONS

3) MONITOR TCAS

4) LOOK FOR CONTRAILS/TRAFFIC

⑧ SECURE FAILED ENGINE:

- AFM → EMERGENCY
- OR QUICK REFERENCE PROCEDURES
- ENGINE SHUTDOWN IN FLIGHT

⑨ START THE APU:

- AFM → NORMAL
- CHAPTER 02 - NORMAL
- ALTERNATE NORMAL
- APU IN FLIGHT OPERATION

⑩ CHANGE DESTINATION AIRPORT:

- 1) **FPL**
- 2) **PREV**
- 3) SCRATCH PAD: XYZ3
- 4) **—** LSK (DEST)
- 5) **—** LSK 6R - ACTIVATE

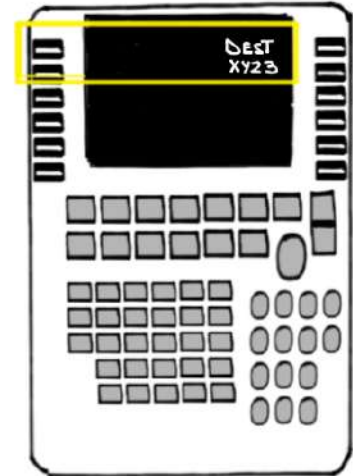

⑪ PROCEED TO ALTERNATE AIRPORT:

- ONCE SAFELY BELOW THE OTS (<FL 290) PROCEED \triangleright TO THE ETP AIRPORT
- UPDATE flight plan winds
- If you HAVEN'T RECEIVED A REVISED ATC CLEARANCE CONTACT ATC AND REQUEST ONE
- SQUAWK TRANSPONDER CODE 7700
- SET ADS-C TO EMERGENCY



⑫ Flight CREW To CABIN CREW: TEST

T = Type of **EMERGENCY**

E = EXIT/EVACUATION plan

S = Signals "TWO MINUTES, TWO MINUTES"

"TEN SECONDS"

"EZ VICTOR"

T = TIME TO PREPARE

⑬ Flight Dispatch/MAINTENANCE DPTs:

- NOTIFY YOUR DISPATCH TEAM ABOUT YOUR SITUATION, INTENTIONS, AND REQUIREMENTS
- THE ABOVE CAN BE DONE THROUGH YOUR COMMUNICATIONS SERVICE PROVIDER (CSP)

SCENARIO # 2

If THE ENGINE had failed prior TO CROSSING
ETP 2 A DIVERSION TO XYZ 2 WOULD HAVE BEEN
NECESSARY

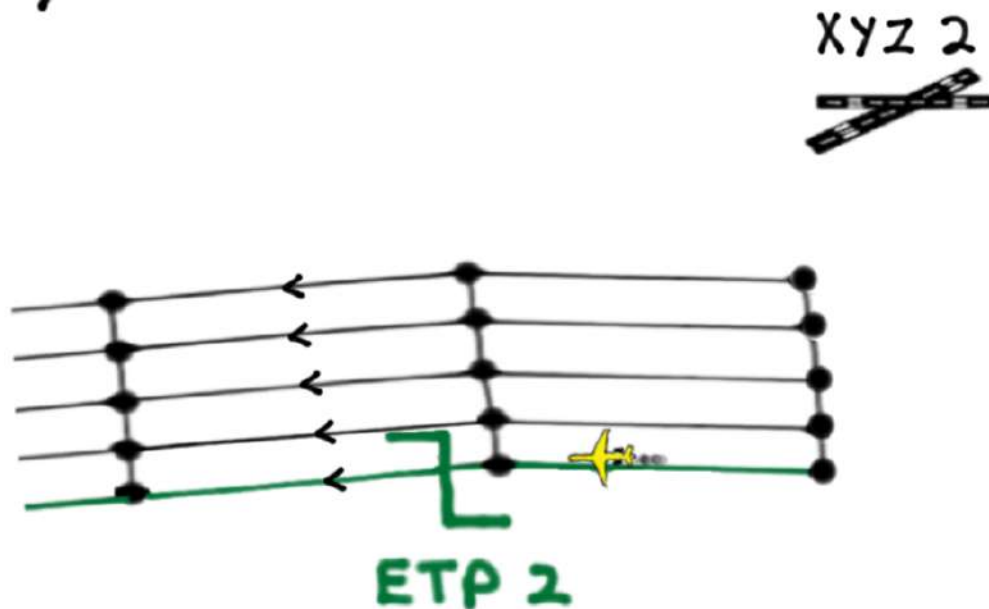

ONCE ESTABLISHED ON A SAME DIRECTION **5** NM LATERAL
OFFSET AN EXPEDITED DESCENT THROUGH FL **290** (THE
BOTTOM OF THE OTS TRACKS) WOULD HAVE BEEN
REQUIRED BEFORE INITIATING A TURN-BACK DIVERSION
ACROSS THE FLOW OF ADJACENT TRAFFIC ABOVE

1ST

5 NM SAME DIRECTION offset

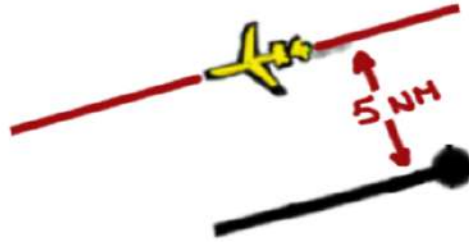

2ND

EXPEDITED DESCENT below OTS

FL420
FL410
FL400
FL390
FL380
FL370
FL360
FL350
FL340
FL330
FL320
FL310
FL290

SPEED BRAKE EXTENDED

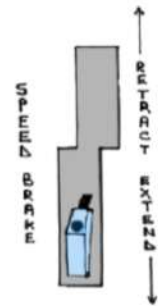

A digital cockpit control panel. The VS-FPA display is highlighted with a yellow box and shows the value "3000". Other displays include SPEED (080), HDG (270), ALTITUDE (27100), and various mode buttons like LNAV, VNAV, and AP.

3RD

DIR

XYZ 2



SPEED 210

ALTITUDE 26500

PART V

SYSTEMS' ASSESSMENT

PTU Hyd ON

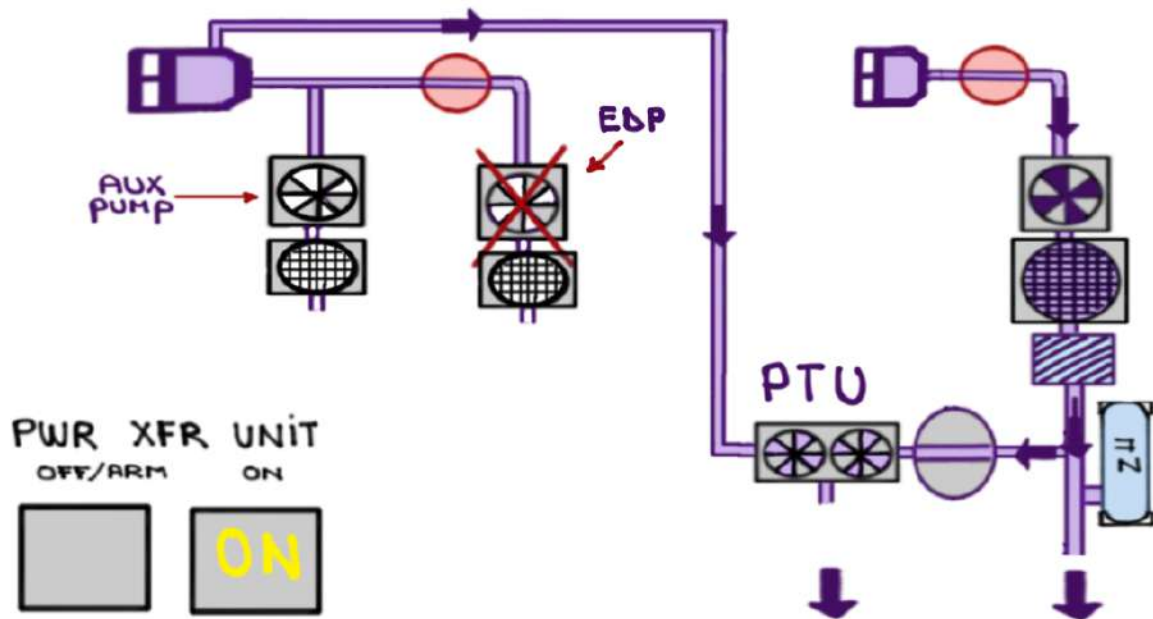

ELECTRICAL SYSTEM

APU GEN AND R IDG POWER all AC and DC BUSES

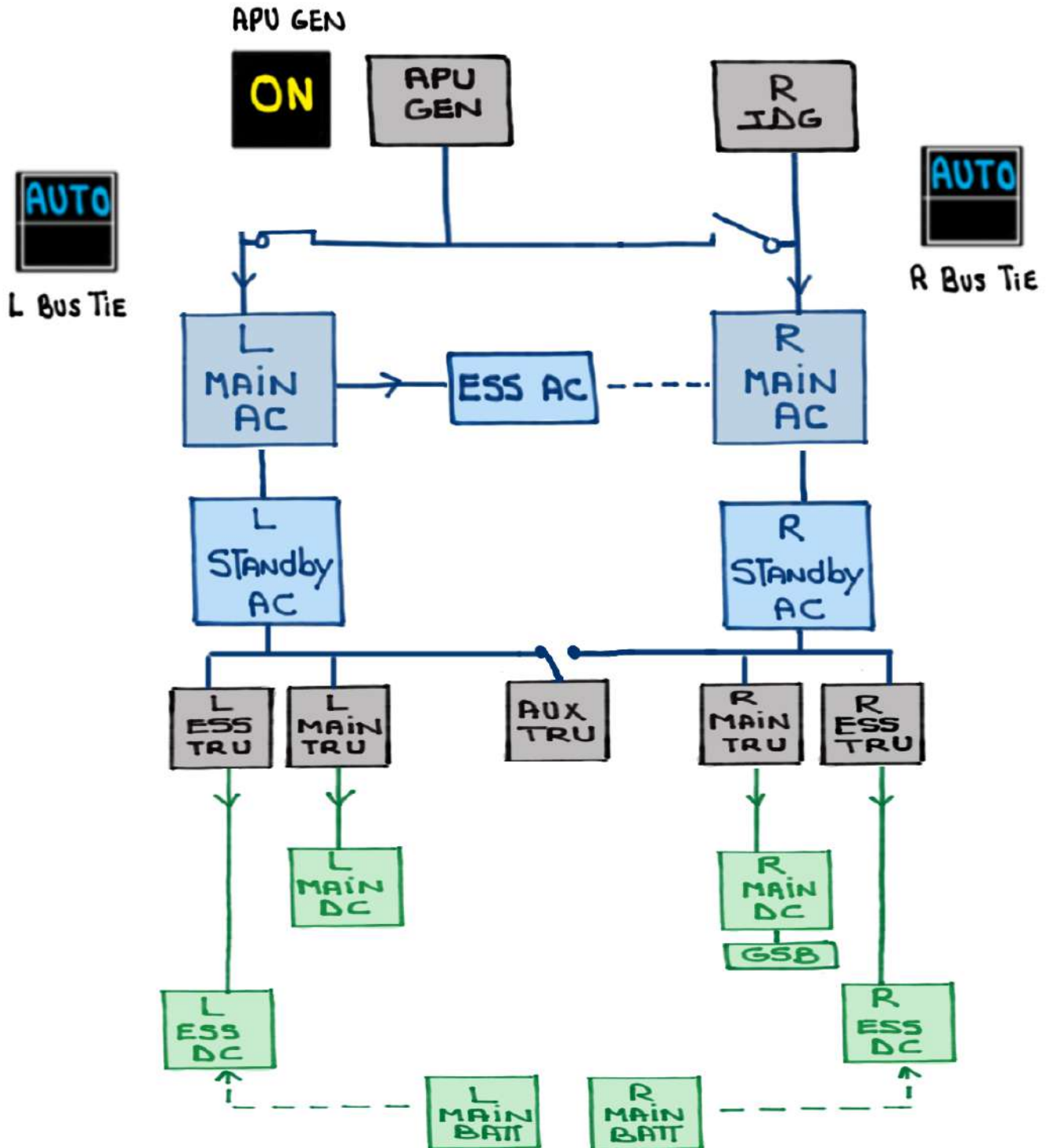

HYDRAULIC SYSTEM

The POWER TRANSFER UNIT (PTU) will TAKE OVER THE DUTIES OF THE INOPERATIVE EDP AS SOON AS L Hyd SYSTEM PRESSURE DROPS below 1500 Psi

- LOSS OF LEFT THRUST REVERSER

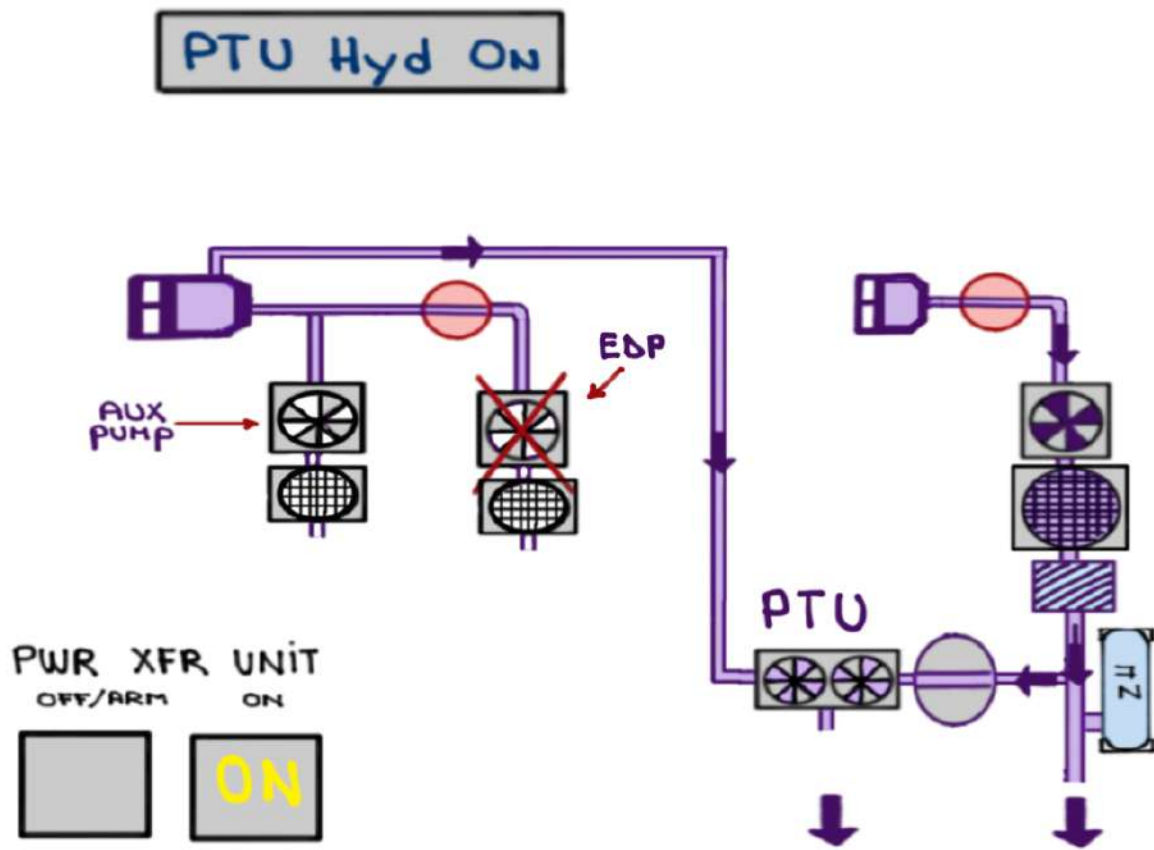

FUEL SYSTEM

All FUEL SYSTEM COMPONENTS OPERATE NORMALLY

A FUEL imbalance condition will develop

- AFM → NORMAL
- CHAPTER 02 - NORMAL
- ALTERNATE NORMAL
- FUEL BALANCING in flight

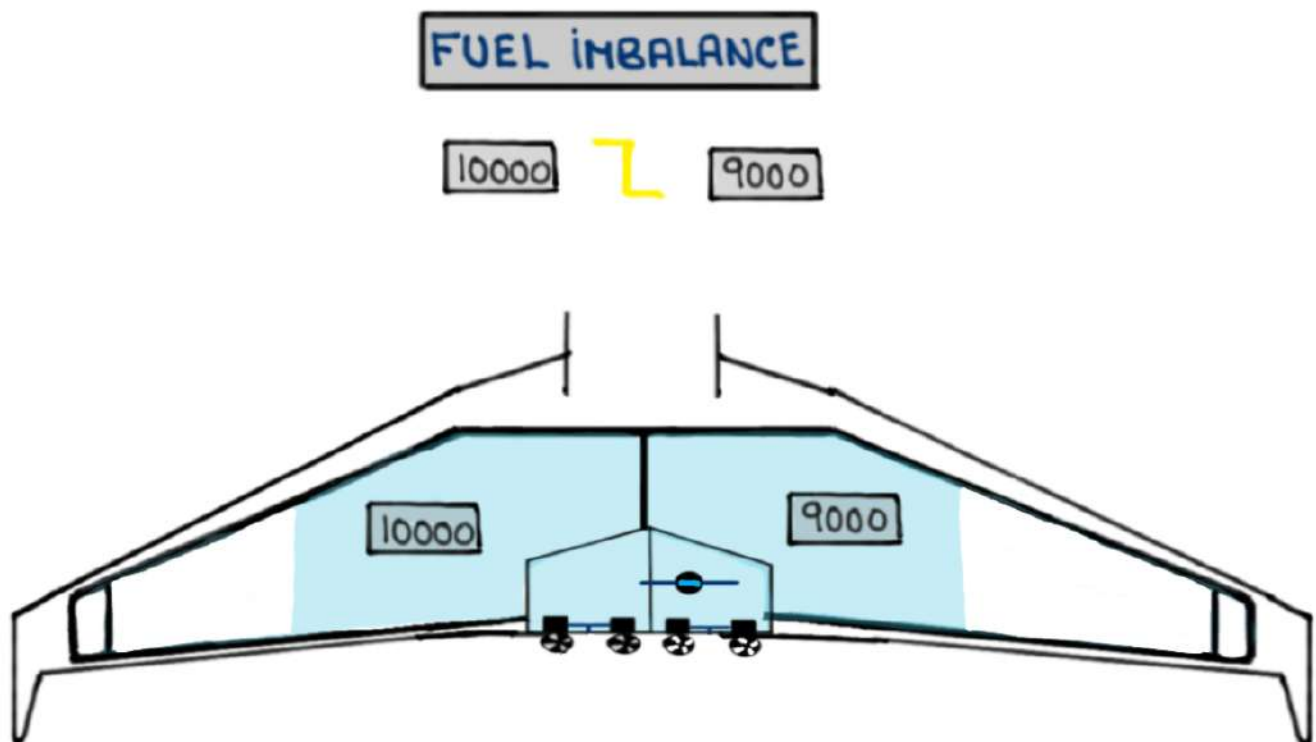

PNEUMATIC SYSTEM

REMAINING ENGINE CAN PROVIDE THE NECESSARY BLEED AIR (High PRESSURE AND TEMPERATURE) VIA ITS ONSIDE MANIFOLD. OPENING THE ISOLATION VALVE ALLOWS THE OPERATING ENGINE TO PROVIDE BLEED AIR TO THE OPPOSITE SIDE'S ECS PACKS

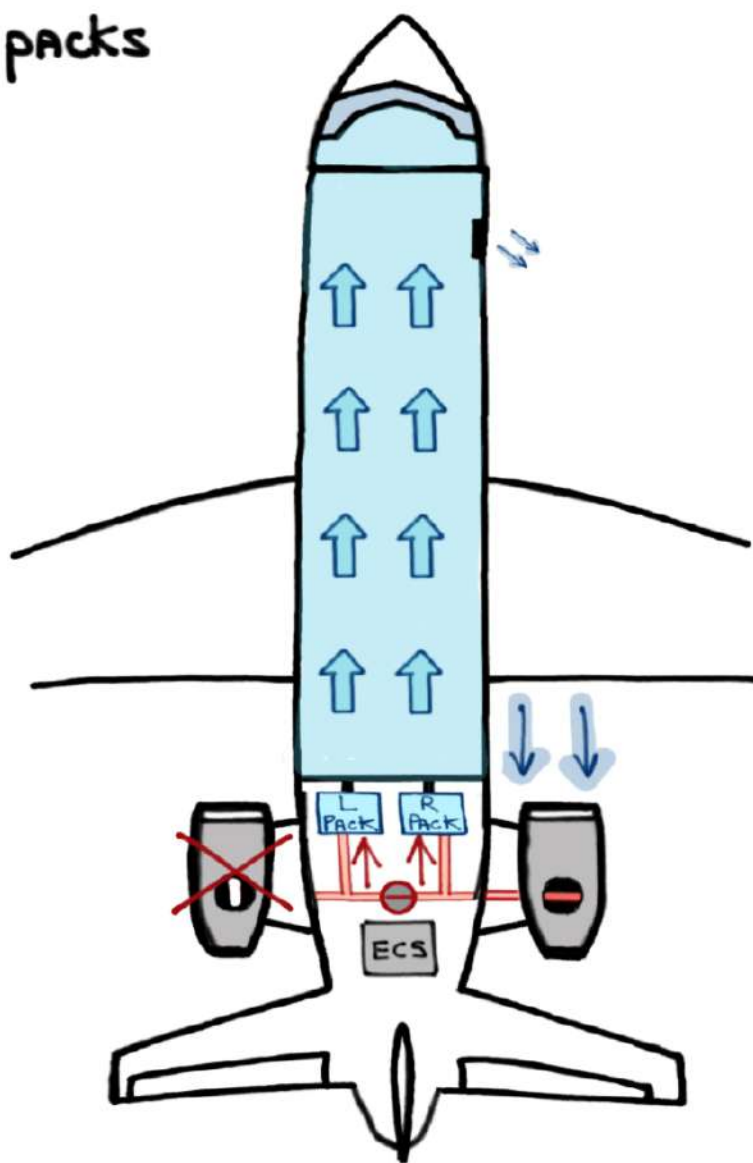

REMINDER: these system notes are intended for study purposes only. Always refer to official Gulfstream manuals and other approved references when operating your aircraft.

NOTE: these system notes are updated from time to time and what is posted on Code450.com will always be the most recent version.

Questions, comments or errors...please do send me an email:
ivan@code7700.com

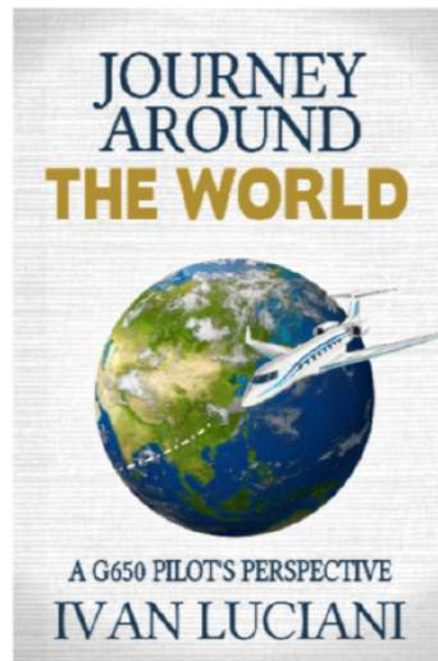
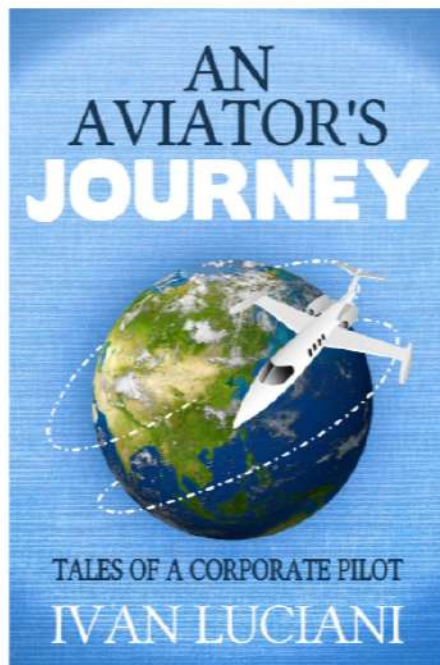

Thank you!