

# G450 PRESSURIZATION System

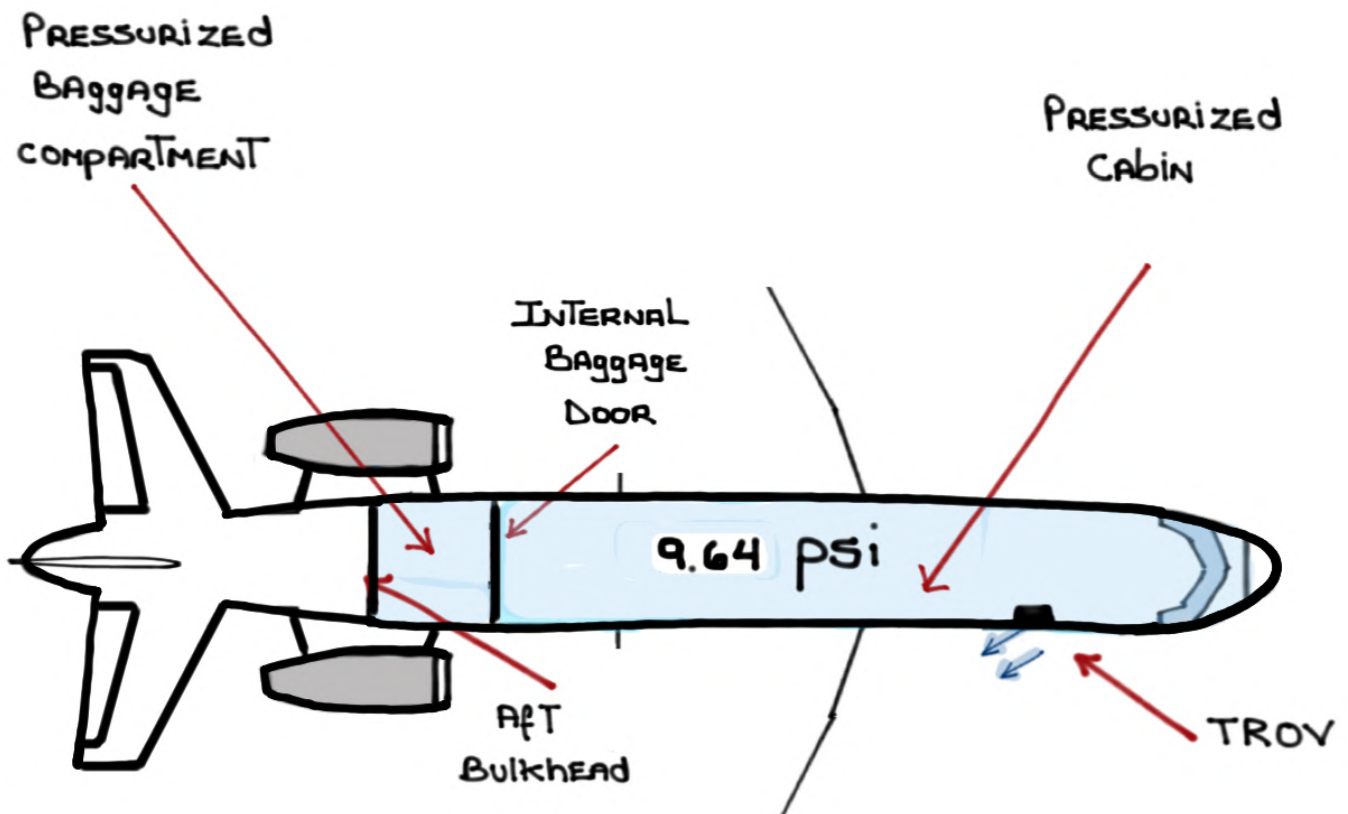

For study purposes only

The Pressurization System controls cabin pressure by modulating the Thrust Recovery Outflow Valve (TROV) in order to achieve and maintain an optimum cabin pressure

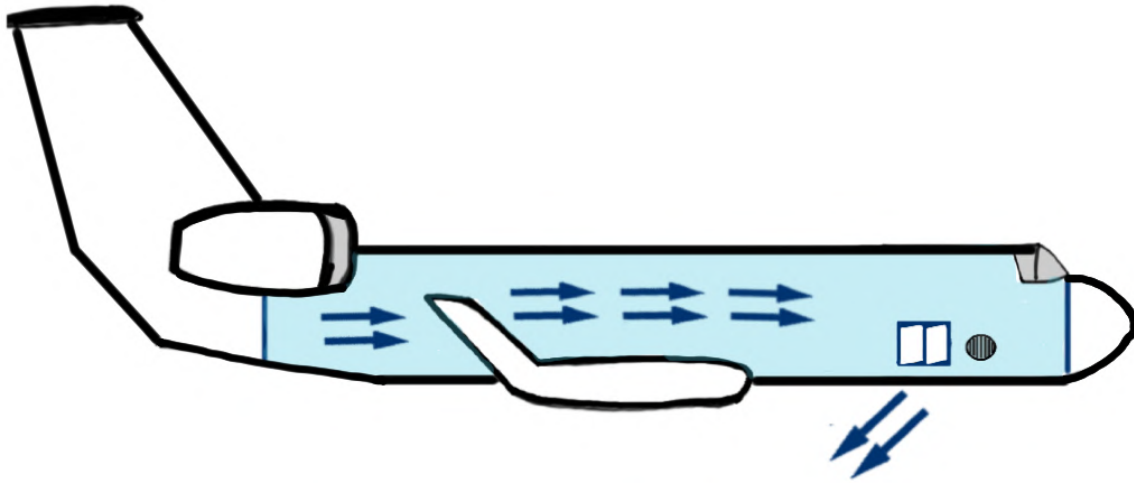

Cabin Air exiting vessel via:

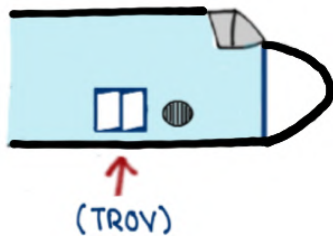

THRUST RECOVERY  
OUTFLOW VALVE  
(TROV)



=

Optimum Cabin Pressure

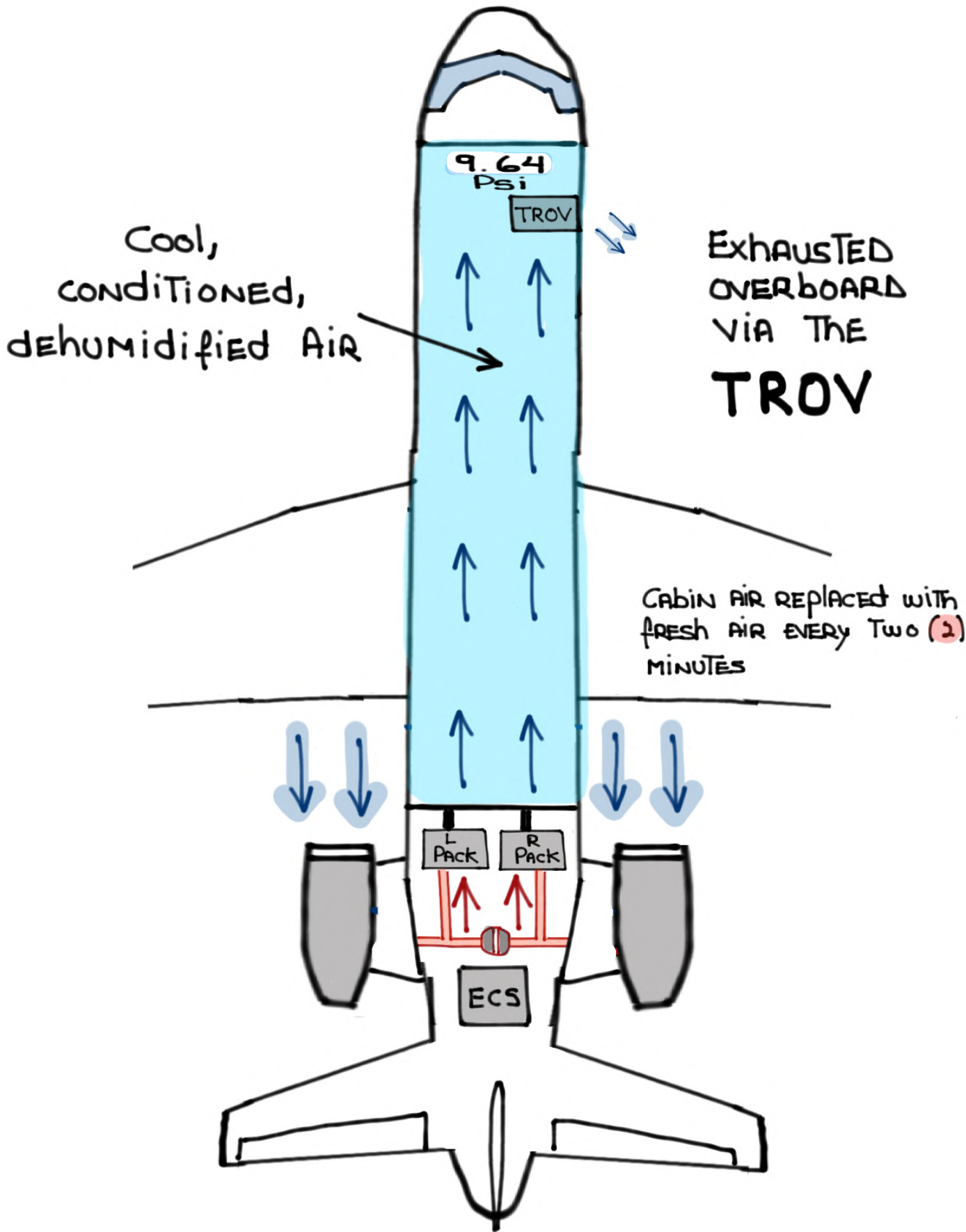

THREE (3)  
OPERATIONAL  
MODES

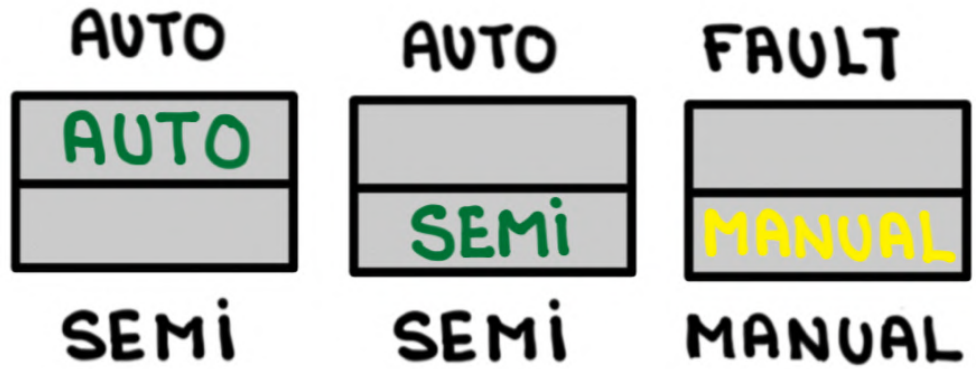

TWO (2)  
PRESSURIZATION  
MODES

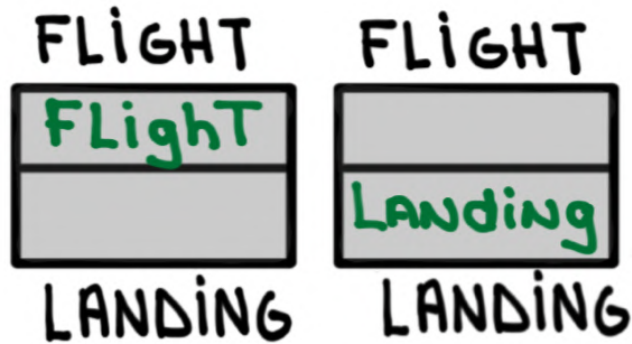

## PSI Limits

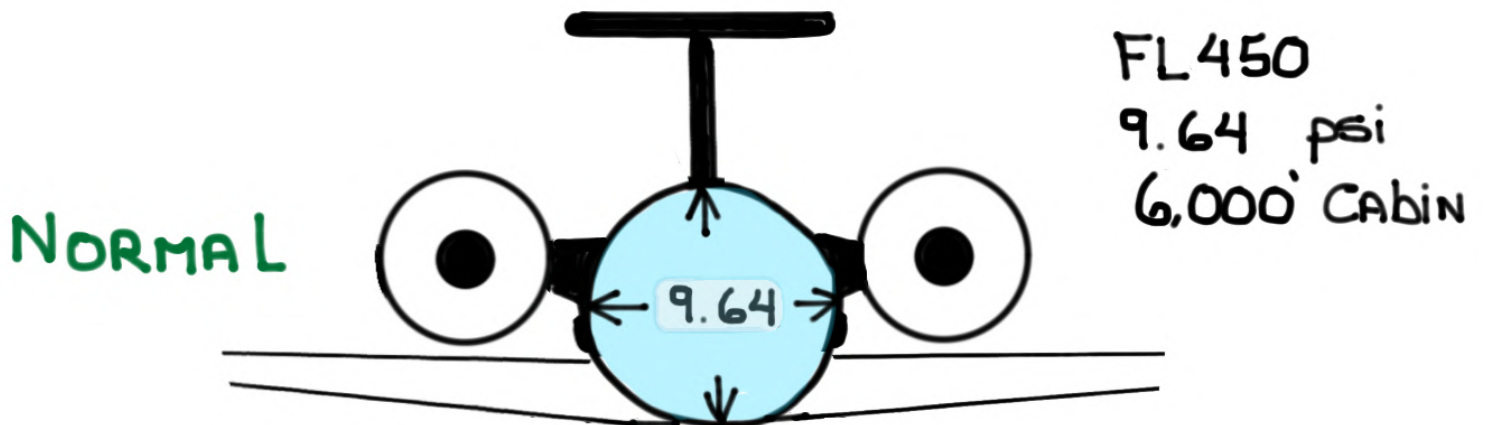

C CABIN DIFFERENTIAL - 9.74 C

MAX 1

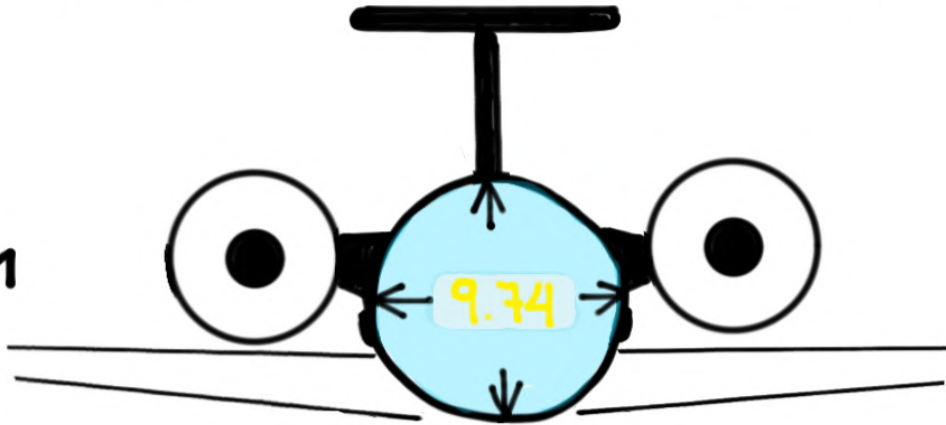

W CABIN DIFFERENTIAL - 9.94 W

MAX 2

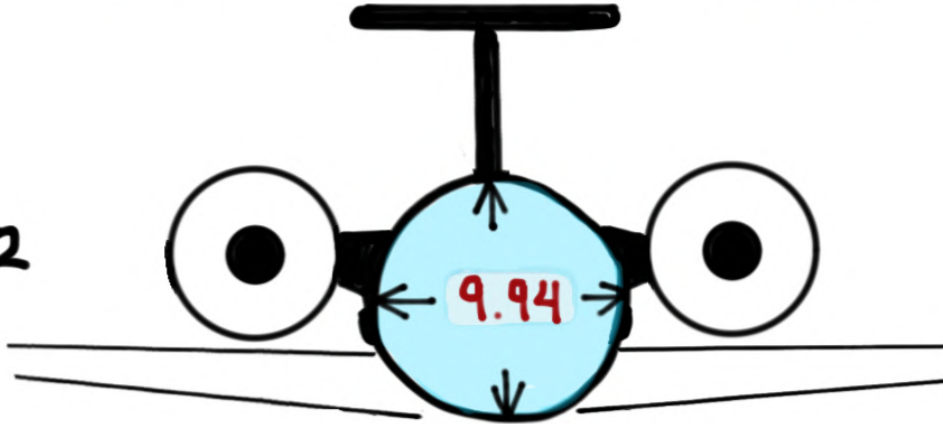

MAX 3

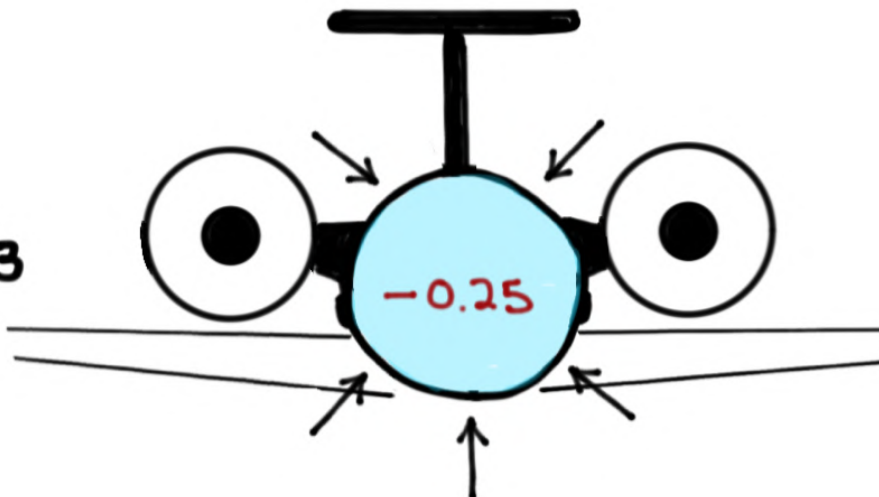

MAX 4

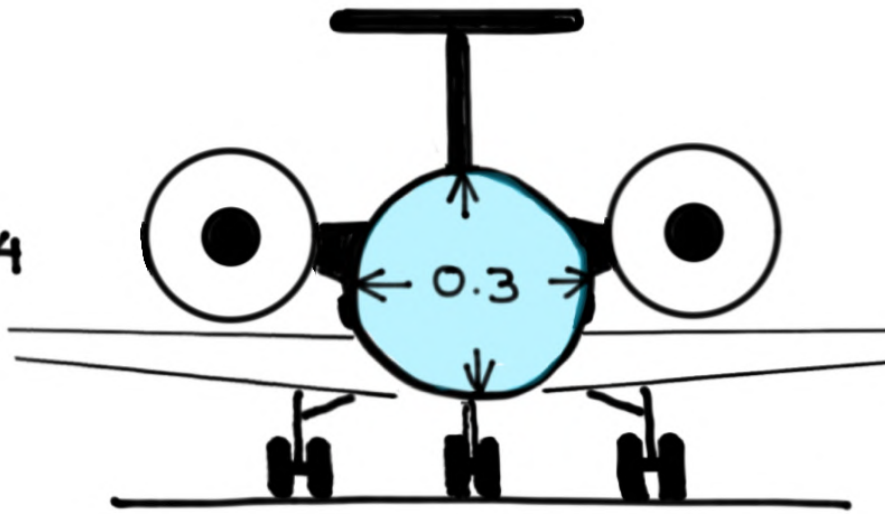

MAX  psi DURING TAXI, TAKEOFF AND LANDING  
SO AS TO ALLOW THE OPENING OF THE **EMERGENCY**  
**EXIT DOORS (EED)** AND MAIN ENTRANCE DOOR (MED)

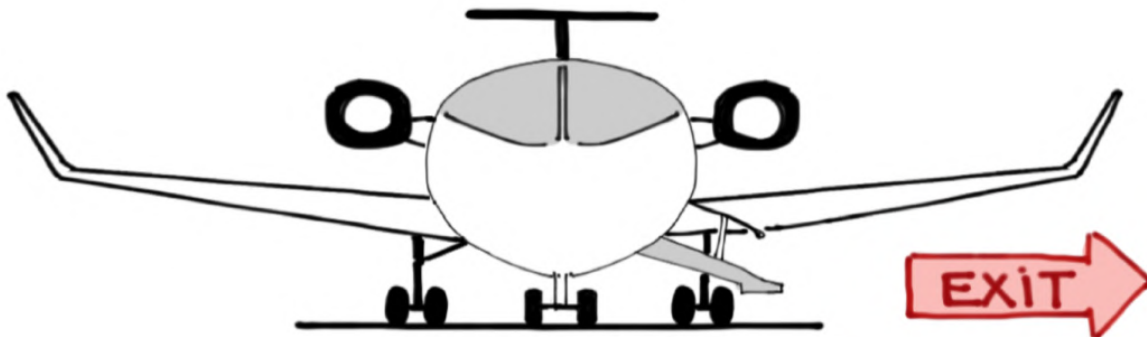
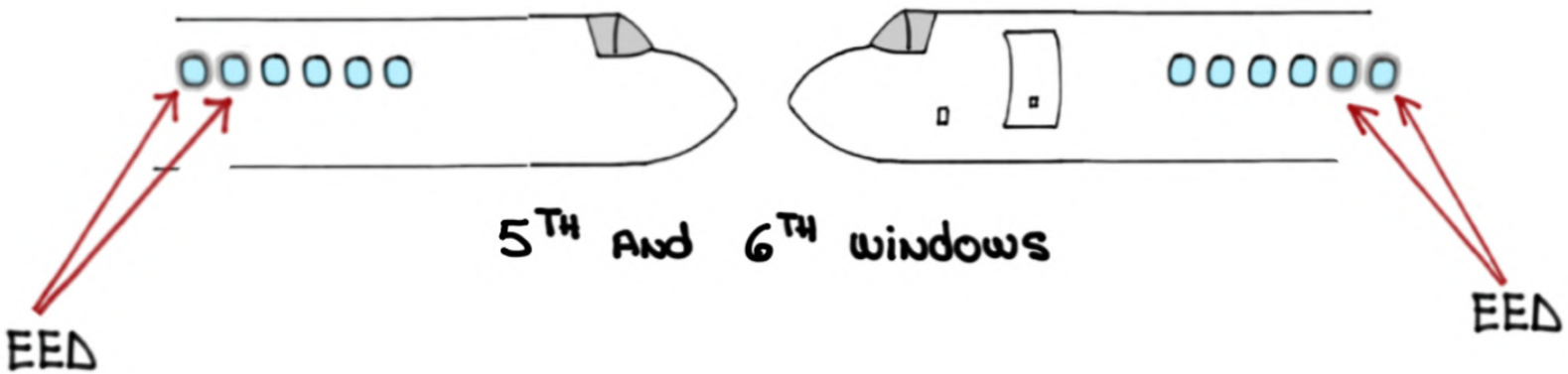

# CABIN PRESSURE CONTROLLER (CPC)

- BRAINS of THE PRESSURIZATION SYSTEM
- MICROPROCESSOR LOCATED IN THE REER WHICH MAKES ALL LOGICAL DECISIONS
- RECEIVES INPUT FROM:

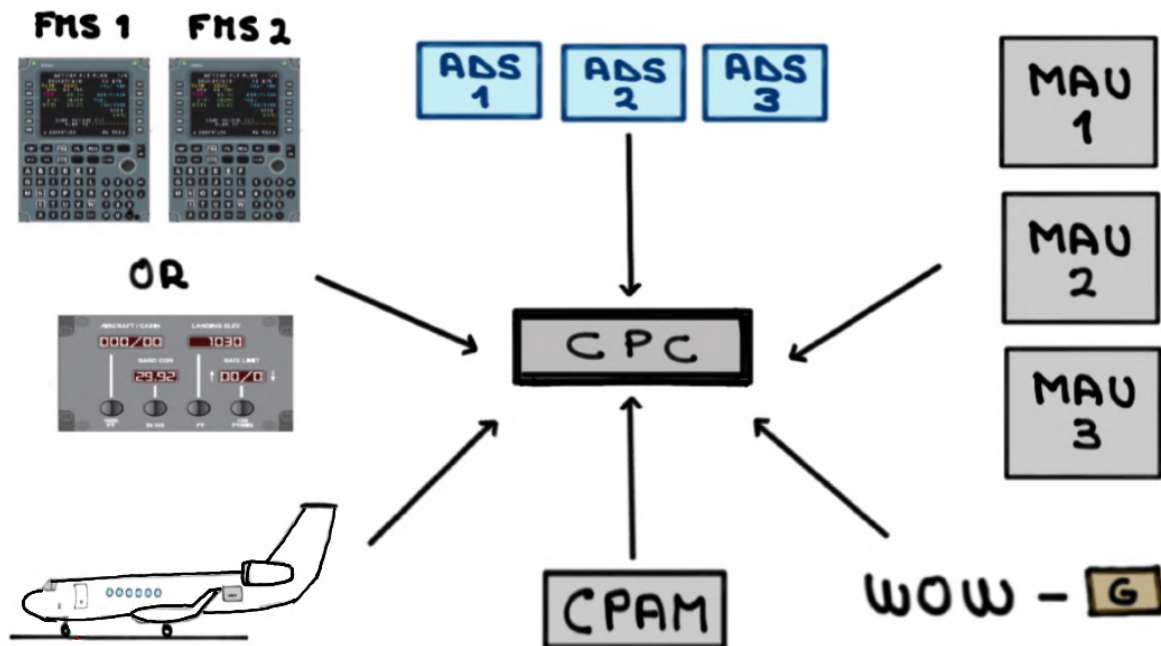

- Two (2) CHANNELS IN **AUTO** AND **SEMI** MODES
- ONE (1) CHANNEL ACTIVE AT THE TIME WHILE THE OTHER CHANNEL REMAINS ON STANDBY

CPC

- 1 2 channels change by:

- REMOVING POWER

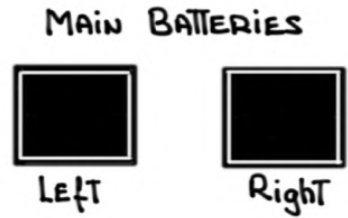

- Cycling MAIN OR baggage door



- SELECTING/deselecting

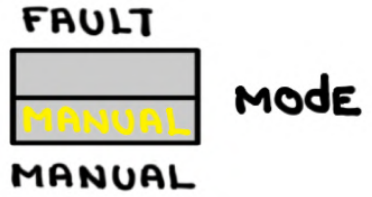

- LOCATED AT THE BOTTOM OF THE REER

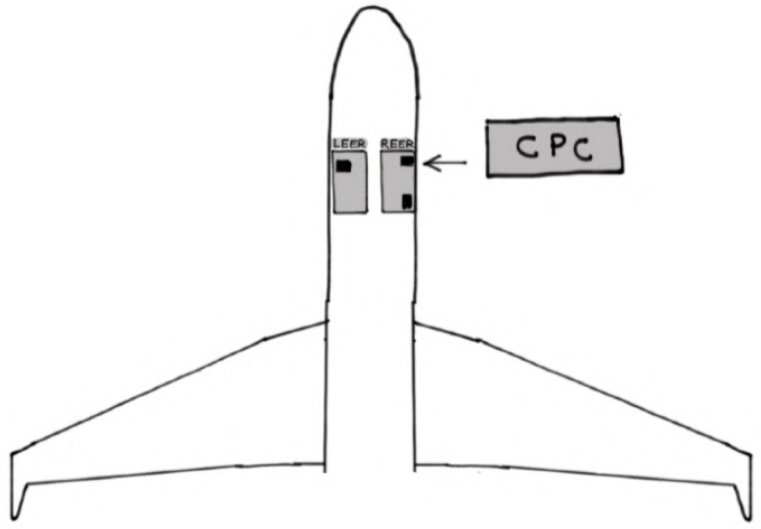



# CABIN PRESSURE ACQUISITION MODULE (CPAM)

- SELF-CONTAINED UNIT LOCATED BENEATH THE **REER**
- STAND-ALONE SOURCE OF CABIN PRESSURE INFORMATION
- CPC CHANNELS COMPARE CABIN PRESSURE DATA WITH EACH OTHER

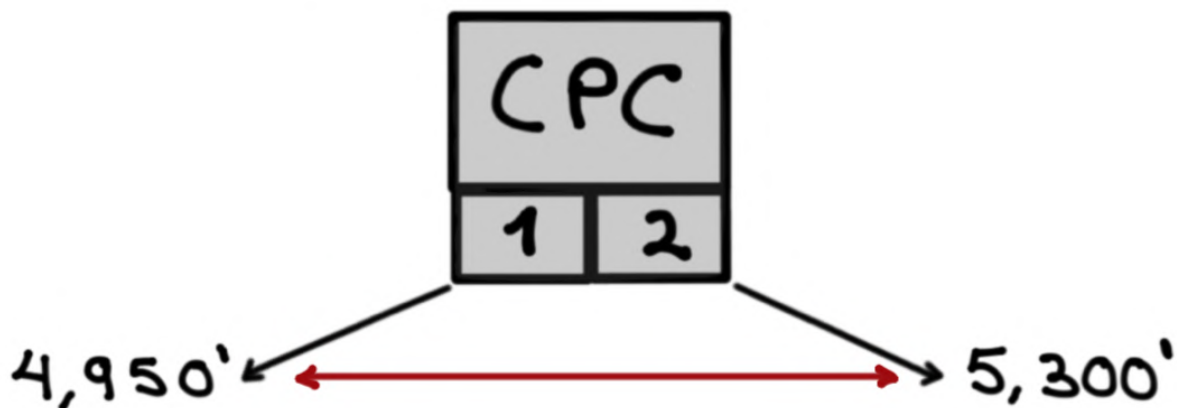

- If channels 1 and 2 differ by  $\geq 310'$  They THEN COMPARE EACH OTHER AGAINST THE **CPAM**
- THE **CPAM** ACTS AS ARBITROR

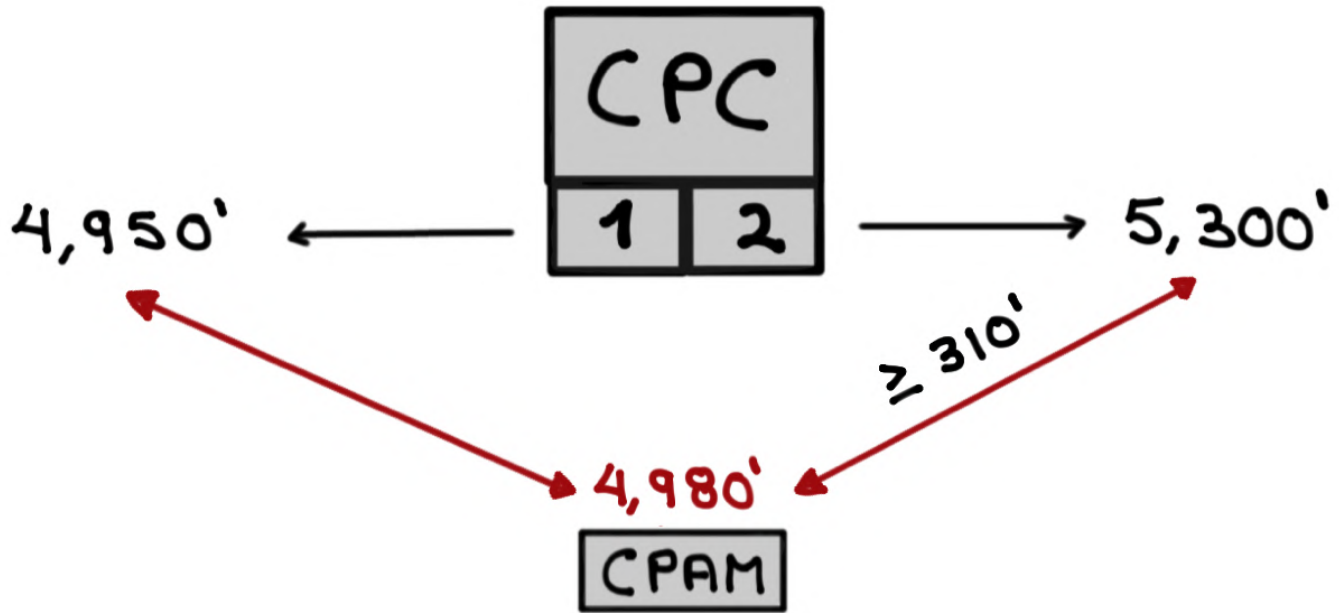

- Any channel that differs by  $\geq 310'$  than the **CPAM** causes that channel to fail

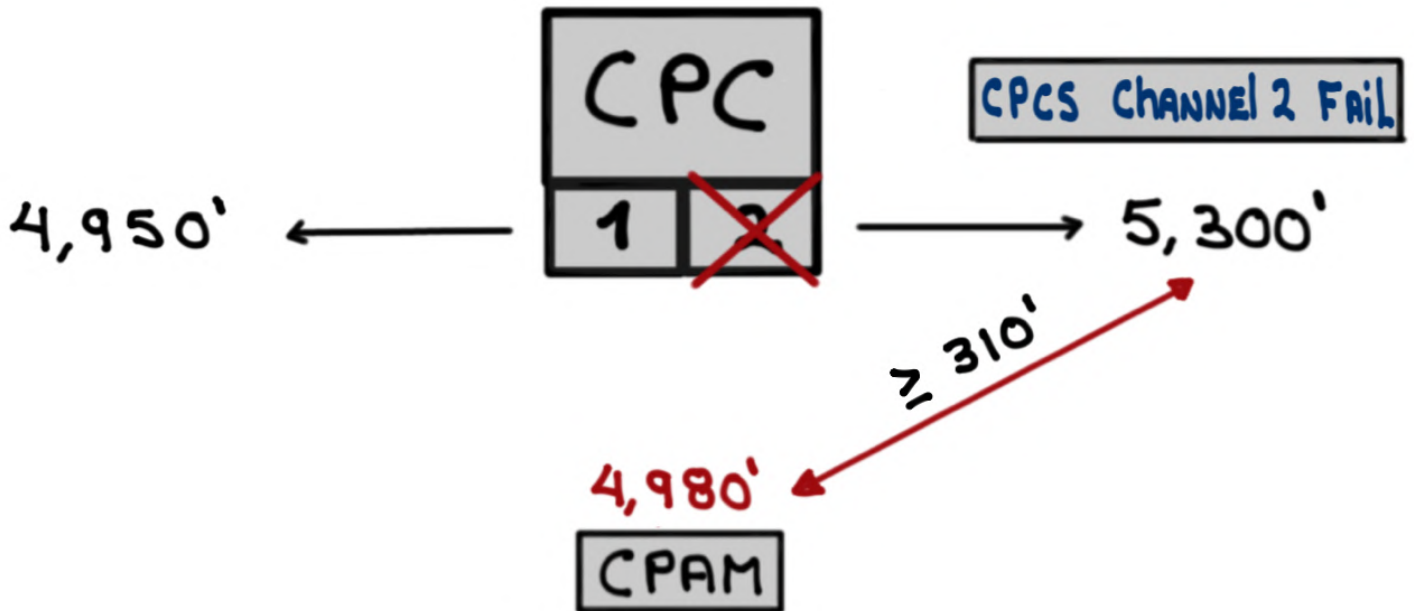

CPCS automatically selects operative channel

# AUTO MODE

- **NORMAL** mode of operation (fully automatic)

- **CPC** controls pressurization based on pressurization schedule

- **CPC** receives input from MCDU data



- Requires **AC** power

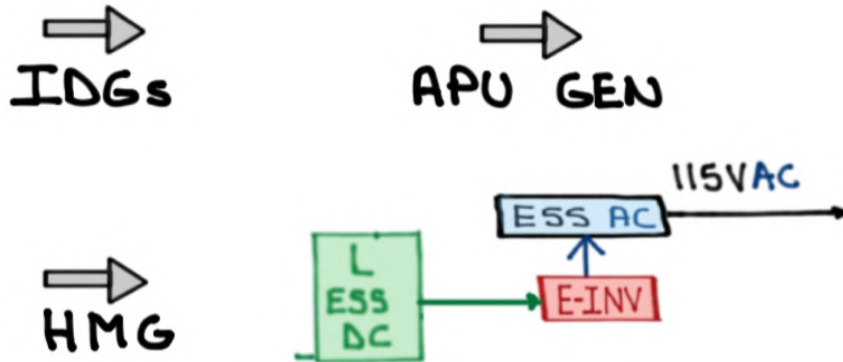

- Pressure Profile modes are automatic

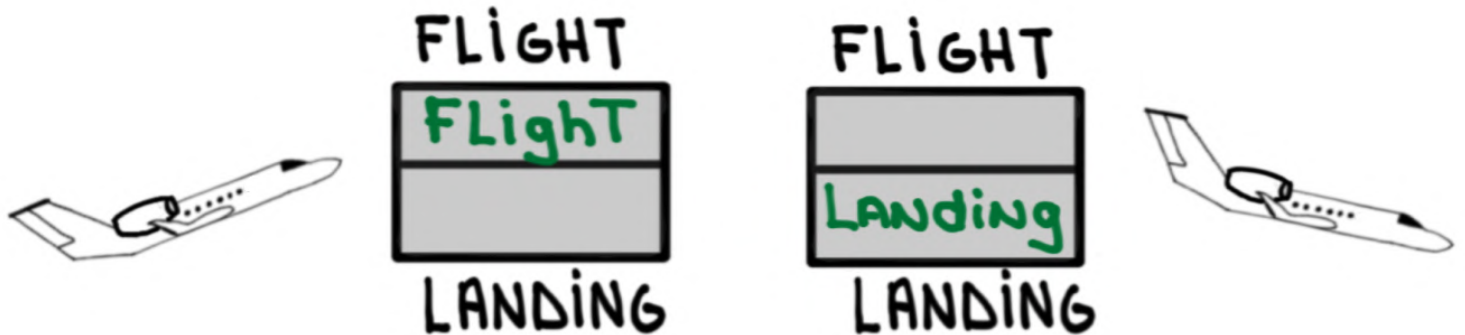

- PRE-PRESSURIZATION TO 0.25 Psi (APPROX. LFE-500') INITIATED IF DOOR CLOSED AND ANY OF THE FOLLOWING OCCUR:

- 1) TAXI SPEED > 9 KNOTS, OR
- 2) THROTTLES ADVANCED  $\geq 15^\circ$  THRUST LEVER ANGLE (TLA), OR
- 3) MANUALLY SELECTED BY THE CREW

**CAUTION** IF RETURNING TO THE RAMP Deselect  IN ORDER TO DEPRESSURIZE THE CABIN PRIOR TO OPENING THE MAIN DOOR

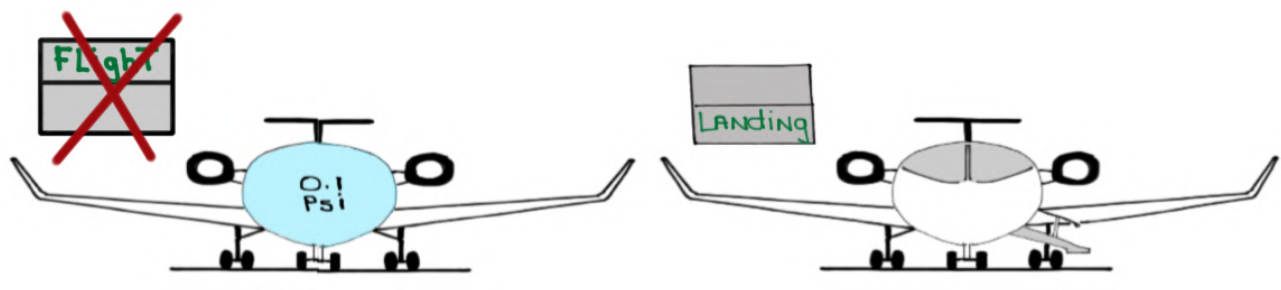

- CABIN RATE OF CLIMB AFTER TAKEOFF: 500 fpm
- DURING DESCENT AS THE AIRCRAFT CROSSES 1,000' BELOW CRUISE ALTITUDE PRESSURE PROFILE CHANGES FROM:

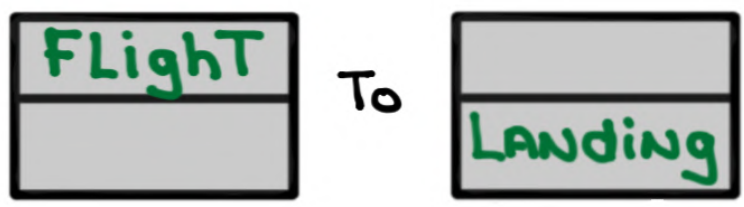

- **CPC** USES DATA FROM  TO CALCULATE DESCENT RATE

- If THE AIRCRAFT LEVELS OFF FOR THREE (3) MINUTES  $\geq$  FL 250  
THE PRESSURE PROFILE CHANGES FROM:



- PRESSURIZATION PROFILE

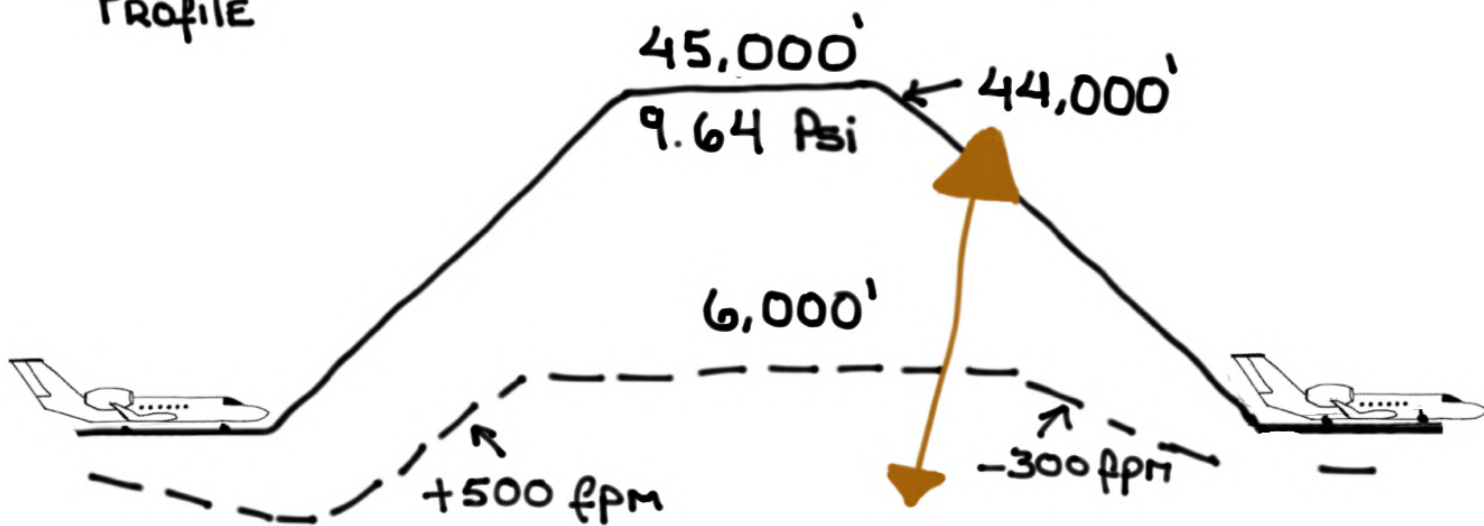

TAXI OUT  
 $> 9$  KTS:

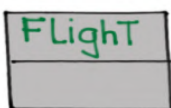

500' BELOW  
FIELD ELEV  
@ 300' FPM

1,000 BELOW  
CRUISE

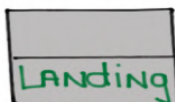

250' BELOW  
FIELD ELEV  
@ 300' FPM



# SEMI MODE

- ALTERNATE NORMAL MODE OF OPERATION (SEMI AUTOMATIC)

- SEMI MODE USED WHEN:

- FMS DATA NOT AVAILABLE OR IS INVALID

- DIRECTED BY THE CHECKLIST

- CREW DISCRETION  $\left\{ \begin{array}{l} \text{QFE OPERATIONS} \\ \text{CREW WANTS MORE CONTROL} \\ \text{OVER THE SYSTEM} \end{array} \right.$

- CREW ENTERS DATA VIA THE CABIN PRESSURE CONTROL PANEL (CPCP)

CPCP



- SAME **AC** AS AUTO MODE

- PRESSURE PROFILE MODES ARE AUTOMATIC

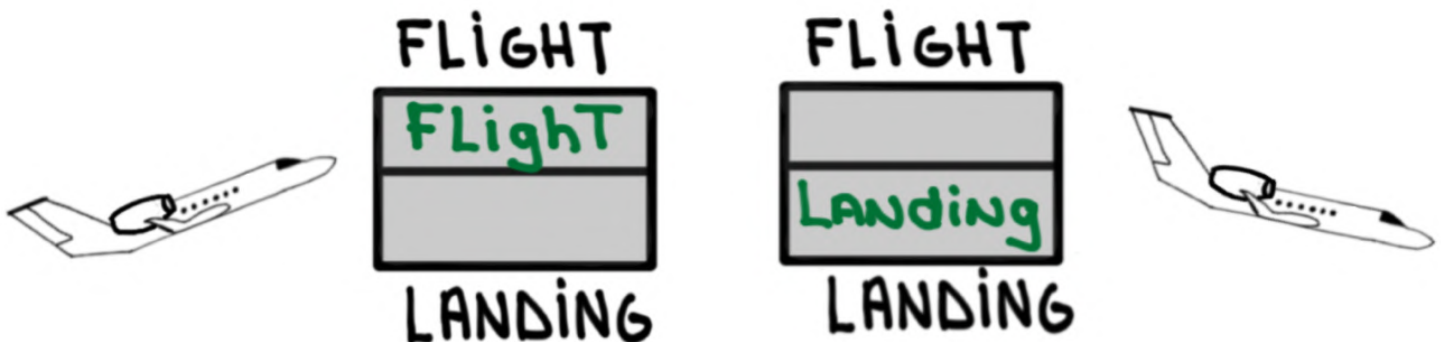

# MANUAL MODE

- If CPC channels are both inoperative the crew can still control the pressurization manually

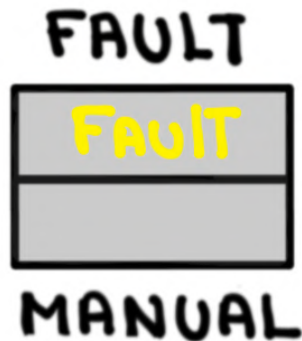
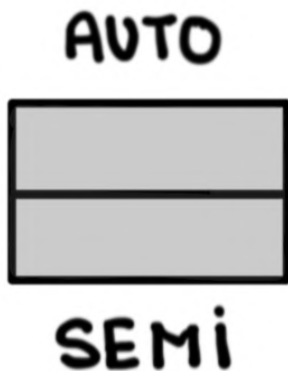

CPCS FAIL - SELECT MANUAL

==

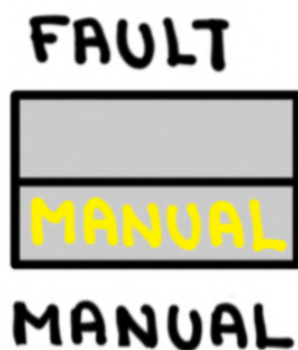

Cabin Pressure Manual

CREW SELECTS MANUAL  
AND CONTROLS TROV



- CREW MANUALLY CONTROLS THE OUTFLOW VALVE (TROV) IN ORDER TO CLIMB, MAINTAIN, AND DESCEND THE CABIN PRESSURE ALTITUDE

- CREW USES THE MAN HOLD KNOB



- REQUIRES **L  
ESS  
DC** POWER

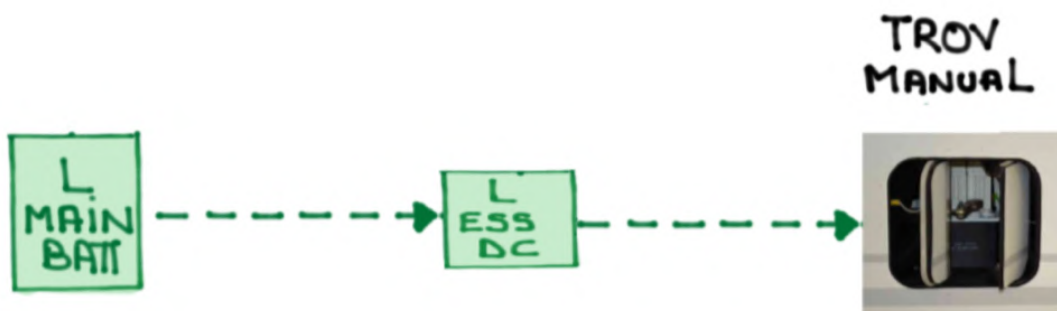

- CABIN PRESSURE ACQUISITION MODULE **CPAM** PROVIDES THE FOLLOWING DATA:

- CABIN ALTITUDE
- CABIN RATE
- CABIN DIFFERENTIAL

# THRUST RECOVERY OUTFLOW VALVE (TROV)

TROV



- LOCATED ON THE RIGHT SIDE OF THE FUSELAGE
- CONTROLLED BY THE **CPC** IN **AUTO/SEMI**
- CONTROLLED BY THE CREW IN **MANUAL**
- SHUTTER-TYPE DOOR DESIGN THAT MINIMIZES DRAG
- THREE (3) ELECTRICAL ACTUATORS (MOTORS)
  - TWO (2) AC AND ONE (1) DC

1

L GEN	R GEN
<b>ON</b>	<b>ON</b>

TROV MOTORS  
SOURCES of POWER



2

L GEN	R GEN	OR	L GEN	R GEN
<b>ON</b>	<b>OFF</b>		<b>OFF</b>	<b>ON</b>



3

APU GEN

**ON**



4

MASTER	LESS	R ESS	HMG Switch ON
<b>ON</b>	<b>ON</b>	<b>ON</b>	



5

MAIN BATTERIES

<b>ON</b>	<b>ON</b>
LEFT	Right

1

AUTO

OR

SEMI

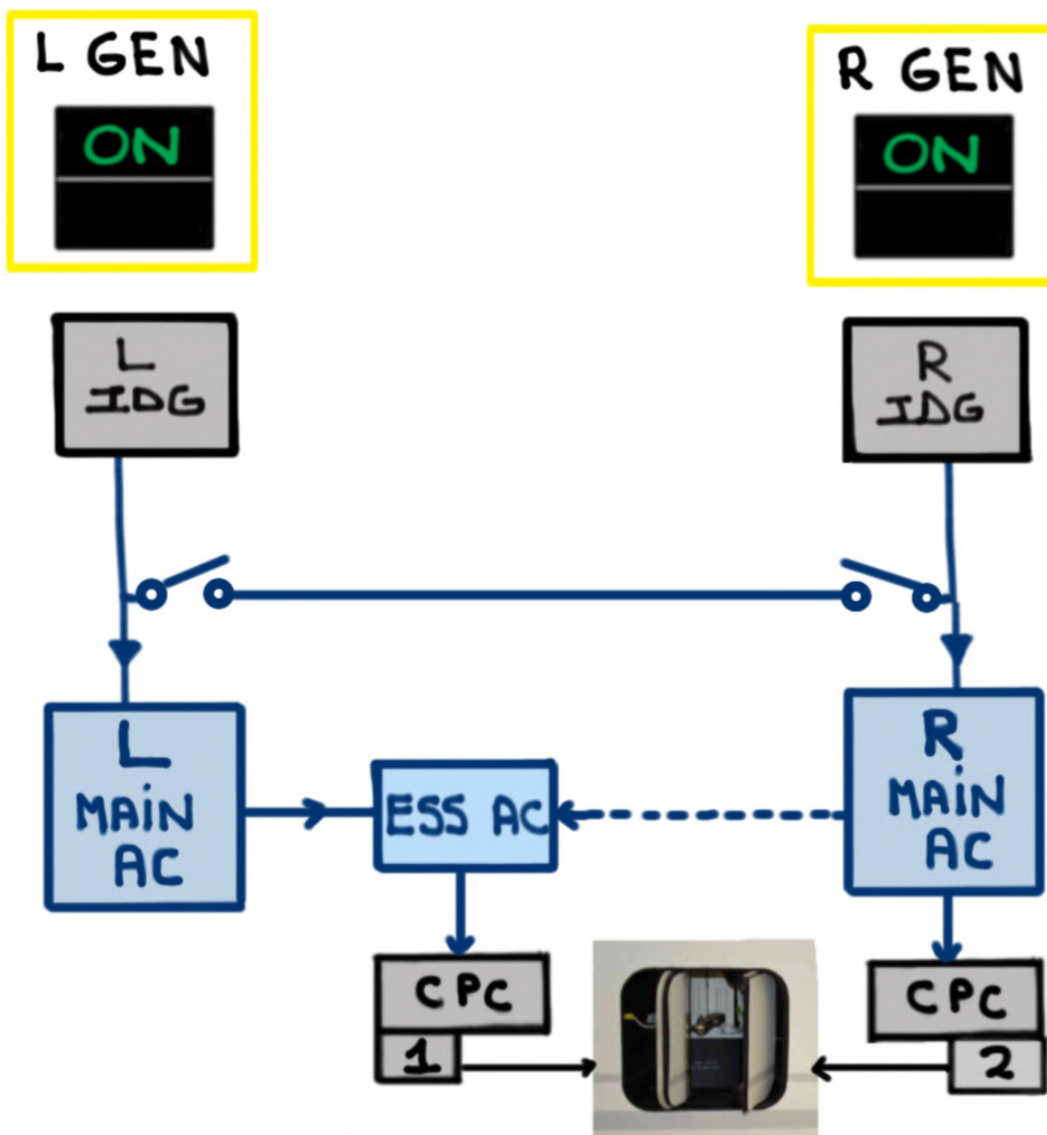

2

AUTO

OR

SEMI

R AC POWER FAIL

R AC RESET

L GEN  
ON

R GEN  
OFF

L IDG

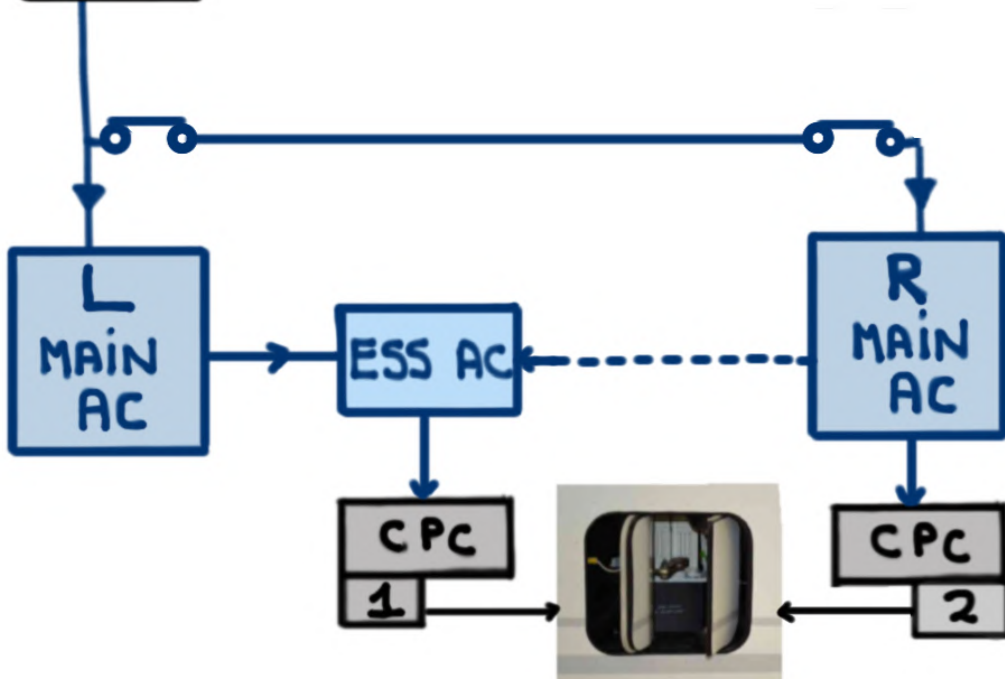

2

AUTO

OR

SEMI

L AC POWER FAIL

L AC RESET

L GEN

OFF

R GEN

ON

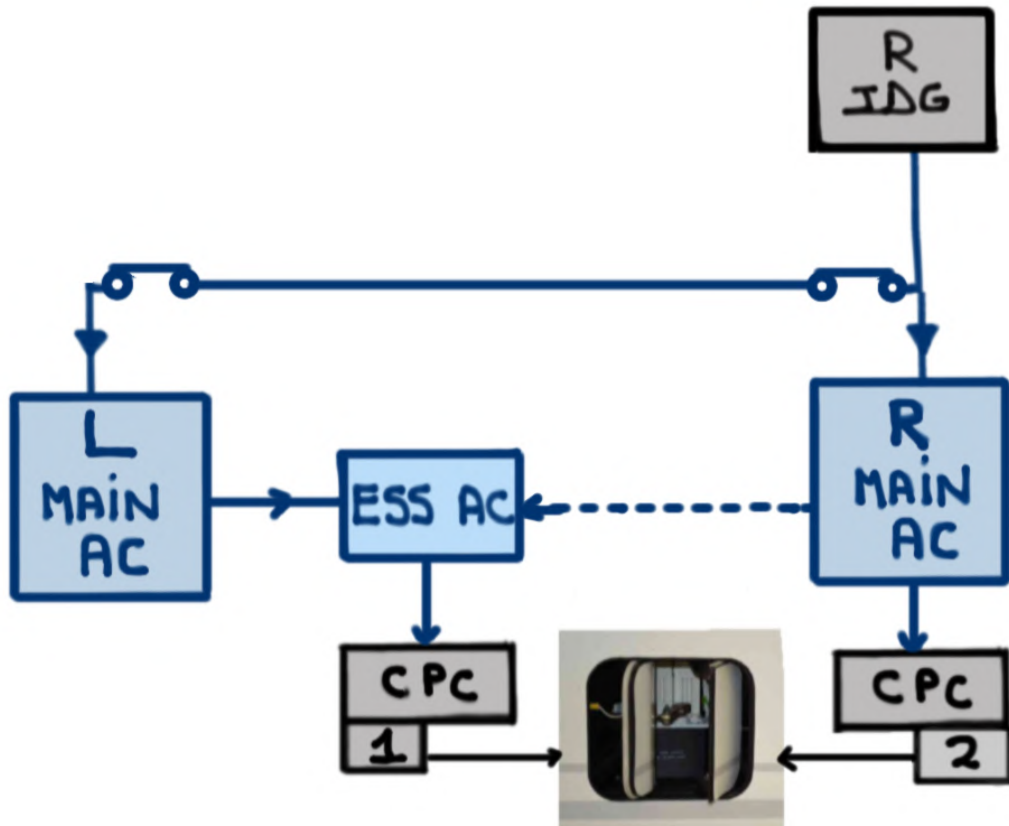

3

AUTO

OR

SEMI

APU GEN  
ON

L-R AC POWER FAIL

L-R AC POWER FAULT

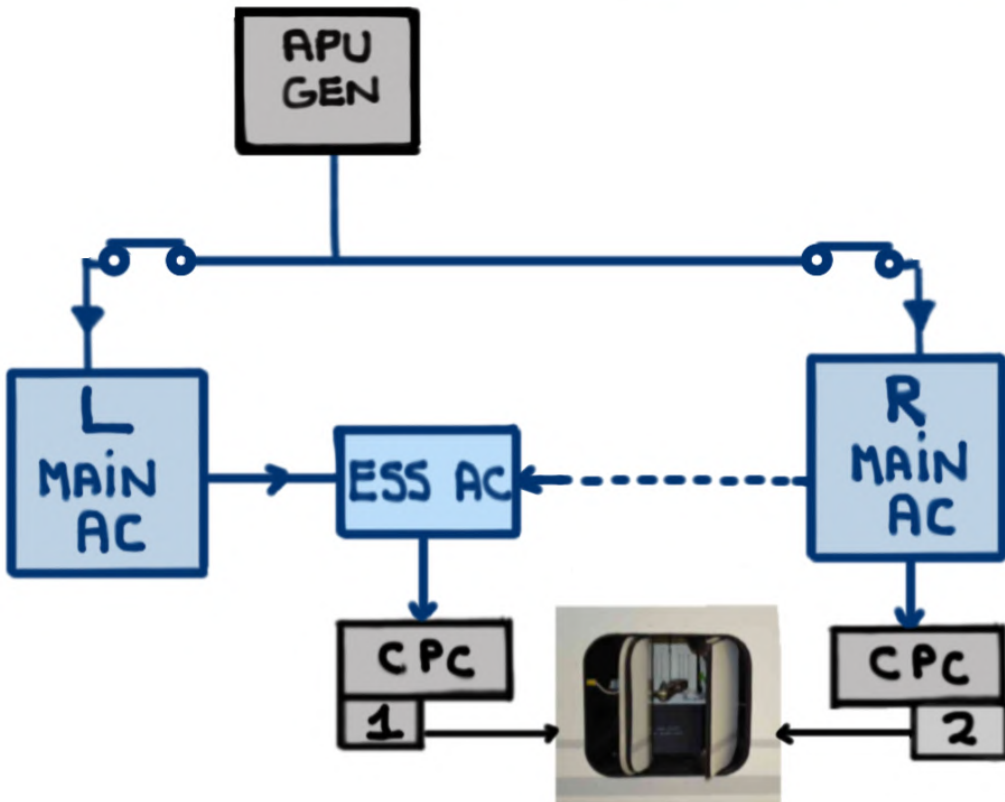

4

AUTO

OR

SEMI

L-R AC POWER FAIL

L-R AC POWER FAULT

APU POWER FAIL

HMG Switch ON

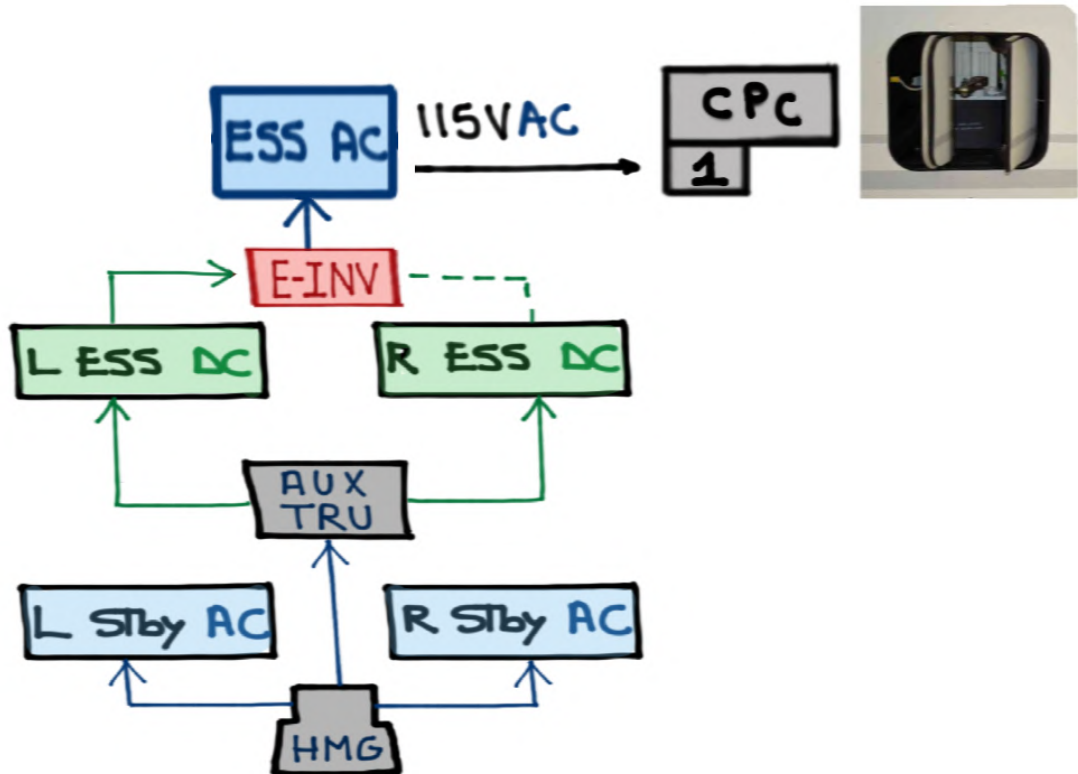
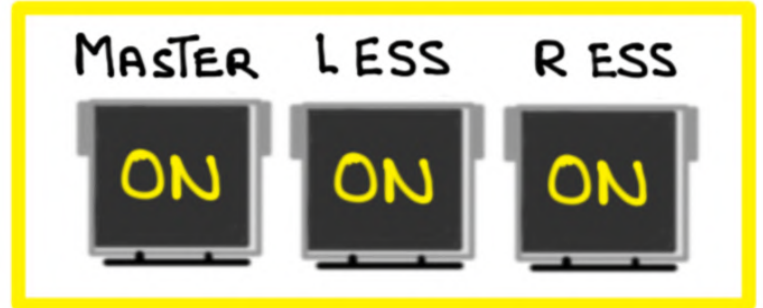



5

AUTO

OR

SEMI

MAIN BATTERIES

ON

ON

Left

Right

L-R AC POWER FAIL

L-R AC POWER FAULT

APU POWER FAIL



~~CPC 1~~ ~~CPC 2~~

FAULT

MANUAL

MANUAL

Cabin Pressure Manual

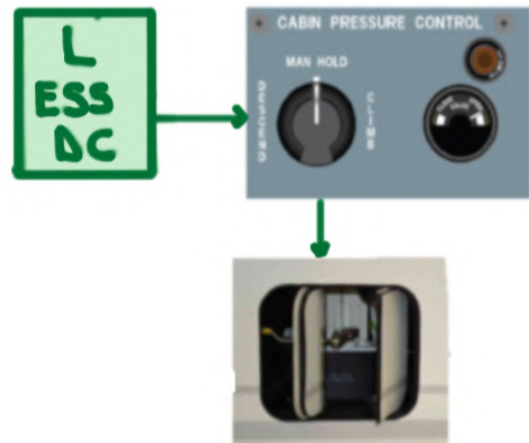

# PRESSURIZED AREAS

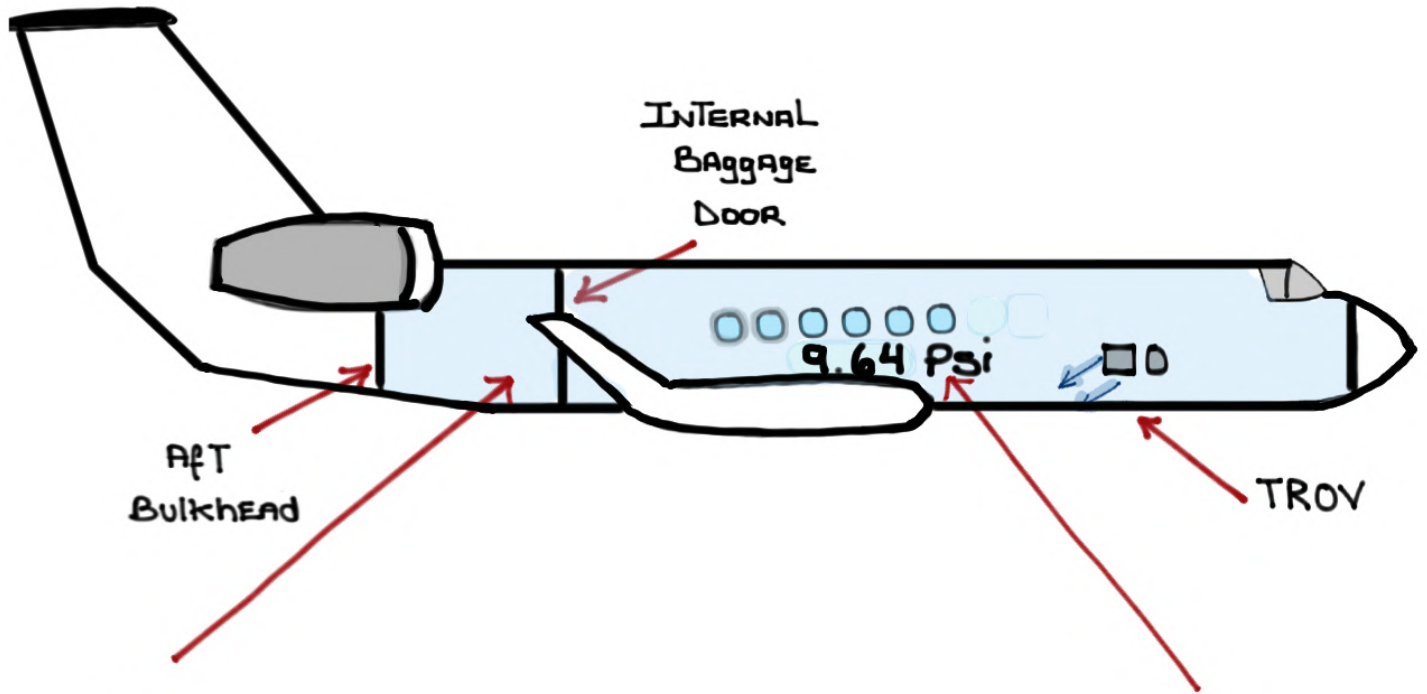

PRESSURIZED  
BAGGAGE  
COMPARTMENT

PRESSURIZED  
CABIN

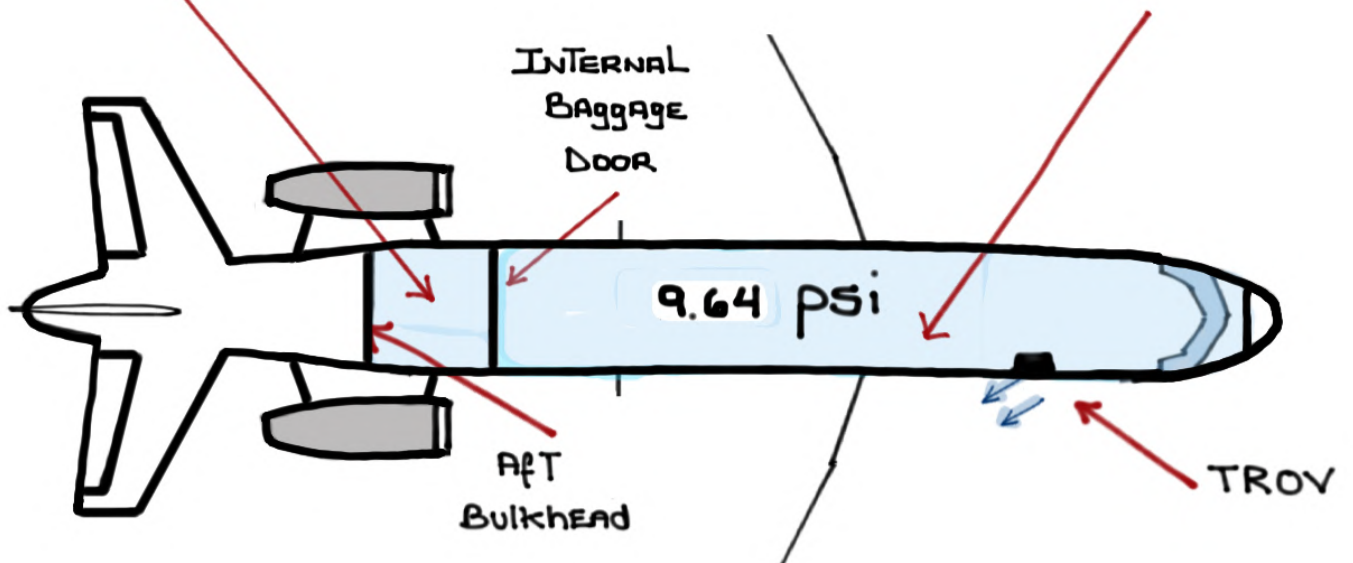

INTERNAL  
BAGGAGE  
DOOR

Aft  
Bulkhead

9.64 psi

TROY

# PRESSURE RELIEF VALVE (PRV)



- The PRV is located just in front of the TROV
- The purpose of the PRV is to protect the aircraft from damage due to excessive POSITIVE or NEGATIVE PRESSURE

## ① POSITIVE DIFFERENTIAL PRESSURE RELIEF:

Two (2) METERING SECTIONS

1<sup>ST</sup> CHAMBER OPENS AT:

2<sup>ND</sup> CHAMBER OPENS AT:



PSI



## ② Negative Differential Pressure Relief:

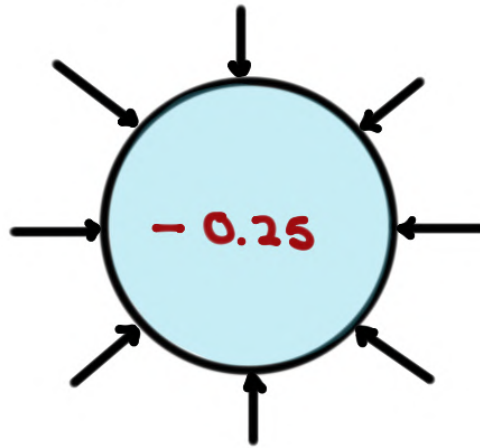

NO CAS MESSAGE

## ③ Ground Pressurization Limiting:

PRV opens sixty (60) seconds after touchdown

- Independently senses cabin pressure using aircraft static ports located on the right side of the fuselage

# STATIC PORTS

- LOCATED ON THE RIGHT SIDE OF THE FUSELAGE
- Two (2) of THESE STATIC PORTS ARE USED BY THE PRV TO SENSE EXTERIOR PRESSURE
- THE THIRD STATIC PORT IS USED BY THE CPAM

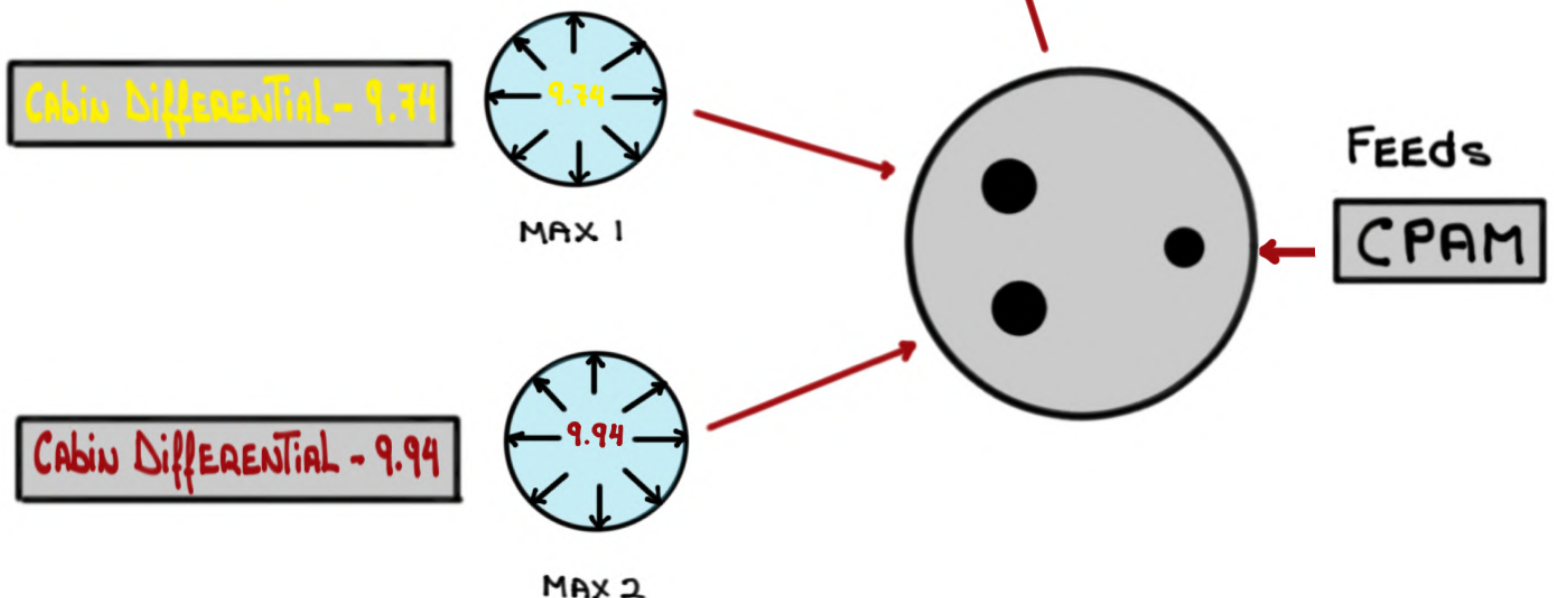

# EMERGENCY DESCENT MODE (EDM)

Autopilot ON

AIRCRAFT ALTITUDE  $\geq$  FL400

**Cabin Pressure Low** CAS MESSAGE

① AutoThrottles engage if desingaged

- Throttles RETARD to idle
- FMA Power display on PFD  $\rightarrow$  FLCH

② GP Lateral Mode - deselected

- FMA Lateral display on PFD  $\rightarrow$  EDM
- COMMAND 90° LEFT TURN

③ GP Vertical Mode - FLCH

- FMA Vertical display on PFD  $\rightarrow$  IAS with ASEL

④ GP Speed mode - MAN

- VMO (340 knots) displays on Speed window

⑤ ALTITUDE - 15,000' in Preselect window

- FLIGHT MODE ANNUNCIATOR (FMA)



- GUIDANCE PANEL (GP)

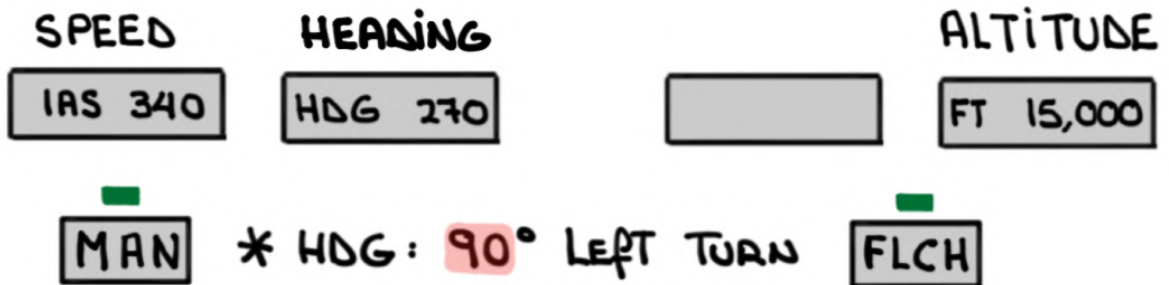

- LEVEL OFF

- FMA VERTICAL display on PFD → ASEL → ALT
- FMA SPEED display on PFD → 340 → 250

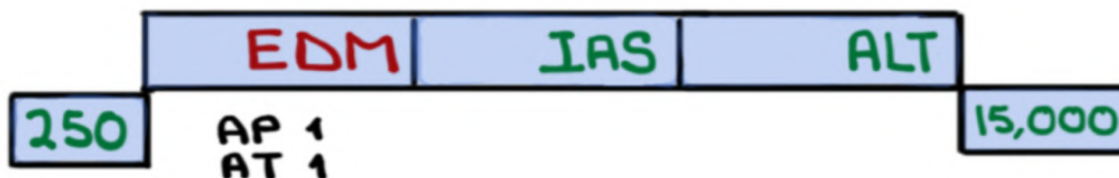

- CANCELING EDM:

- AP DISCONNECT BUTTON, OR
- Deselect AP ON GP

# CABIN PRESSURE LOW TRIP POINTS

MODE                      LANDING FIELD ELEVATION                      CABIN ALTITUDE

MODE	LANDING FIELD ELEVATION	CABIN ALTITUDE
<p><b>FAULT</b></p> <div style="border: 1px solid black; padding: 5px; text-align: center;"> <p style="background-color: #cccccc;"> </p> <p style="background-color: #cccccc; color: yellow;">MANUAL</p> </div> <p><b>MANUAL</b></p>	N/A	<div style="border: 1px solid black; padding: 2px; color: red; text-align: center;">CABIN PRESSURE LOW</div> <p>8,000'</p>
<p><b>AUTO</b></p> <div style="border: 1px solid black; padding: 5px; text-align: center;"> <p style="background-color: #cccccc; color: green;">AUTO</p> <p style="background-color: #cccccc; color: green;">SEMI</p> </div> <p><b>SEMI</b></p>	<p>&gt; 14,000'</p> <p>9,500' - 14,000'</p> <p>7,500' - 9,500'</p> <p>SEA LEVEL - 7,500'</p>	<div style="border: 1px solid black; padding: 2px; color: red; text-align: center;">CABIN PRESSURE LOW</div> <p>≥ 15,500'</p> <p>≥ 14,500'</p> <p>≥ 10,000'</p> <p>≥ 8,000'</p>



# Oxygen Requirements / Operations

Above 41,000' ONE pilot MUST be ON oxygen - FAR 91

CREW AND PASSENGER MASKS NOT APPROVED FOR USE

ABOVE 40,000' CABIN ALTITUDE

ABOVE 35,000' ONE pilot MUST be ON oxygen if THE OTHER pilot LEAVES THE cockpit - FAR 91

PASSENGER MASKS will NOT provide sufficient oxygen ABOVE 34,000' CABIN ALTITUDE

ABOVE FL250 CREW MASKS MUST be in the quick donning position which allows donning within FIVE (5) SECONDS

AUTOMATIC deployment of PASSENGER oxygen MASKS AT 14,750' ± 250' (15,750' ± 250' with ALT SELECT)



REFER TO AFM 01-35-10 TO DETERMINE REQUIRED oxygen QUANTITY FOR DEPARTURE

**REMINDER:** these system notes are intended for study purposes only. Always refer to official Gulfstream manuals and other approved references when operating your aircraft.

**NOTE:** these system notes are updated from time to time and what is posted on Code450.com will always be the most recent version.

Questions, comments or errors...please do send me an email:  
[ivan@code7700.com](mailto:ivan@code7700.com)



Thank you!