

G550 AIR CONDITIONING SYSTEM

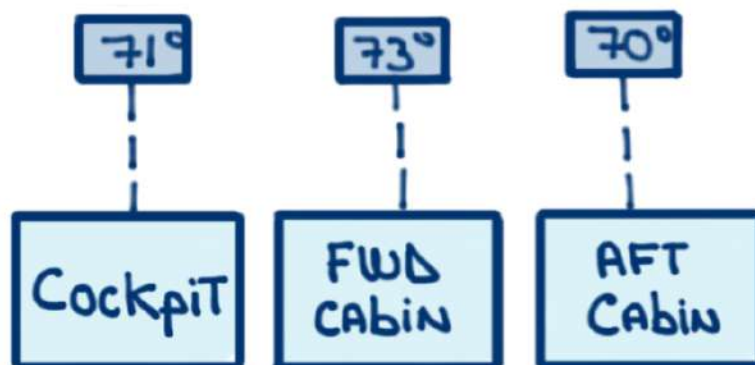

For study purposes only

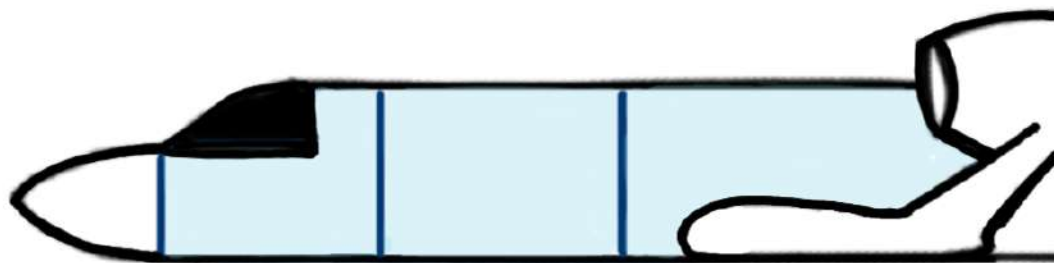
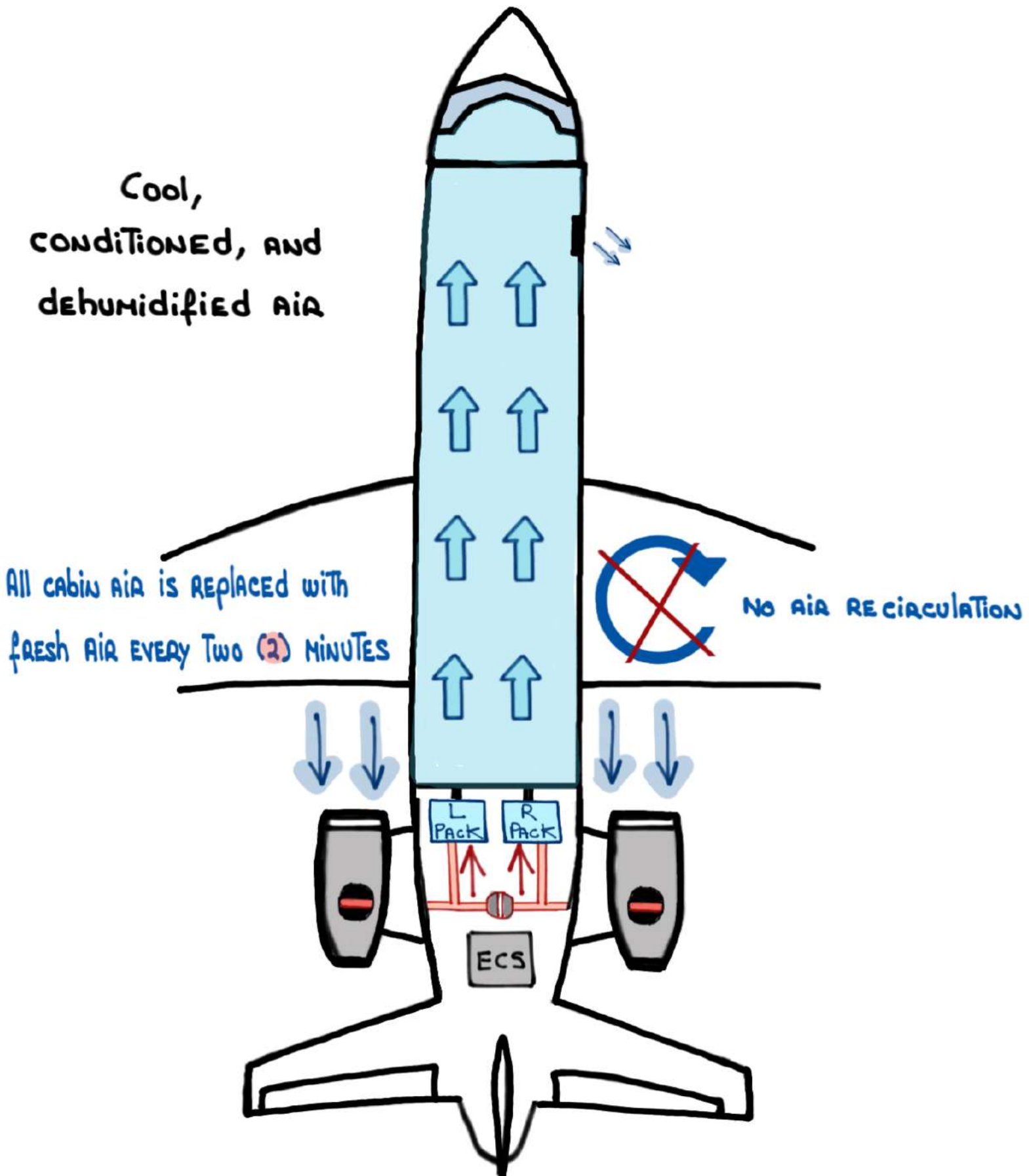

PNEUMATIC SYSTEM

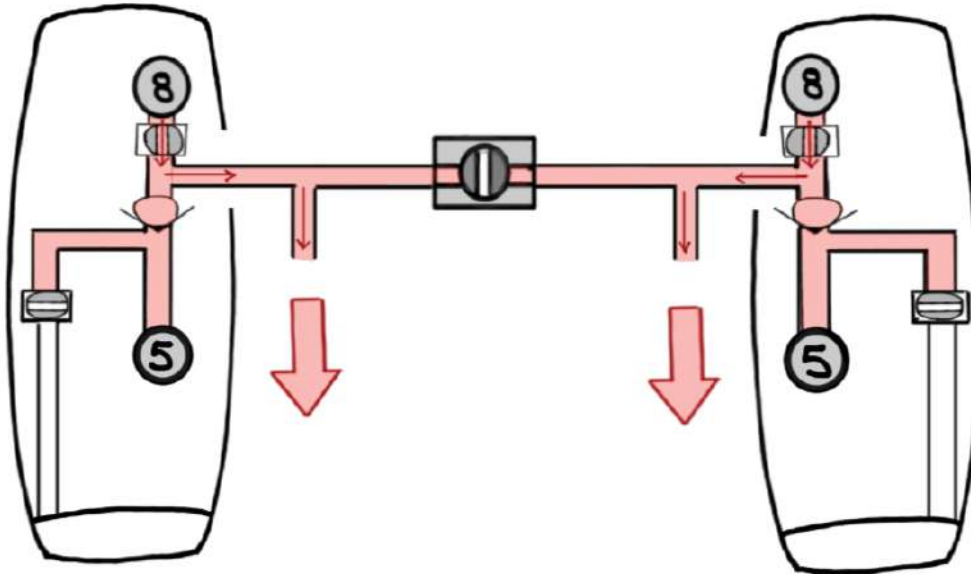

PROVIDES

High PRESSURE Air
TEMPERATURE

(BLEED Air Manifold)



Air Conditioning System

AIR CONDITIONING SYSTEM

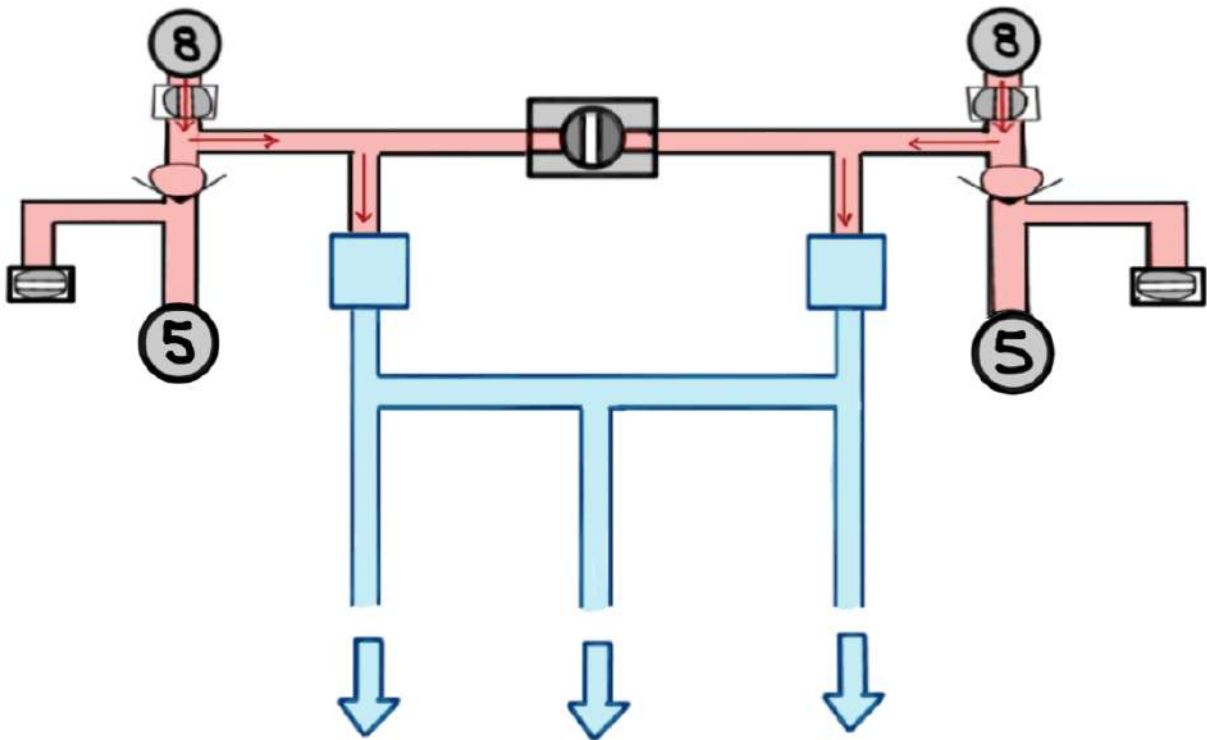

CONTROLS

QUALITY AND QUANTITY
of
AIR ENTERING VESSEL

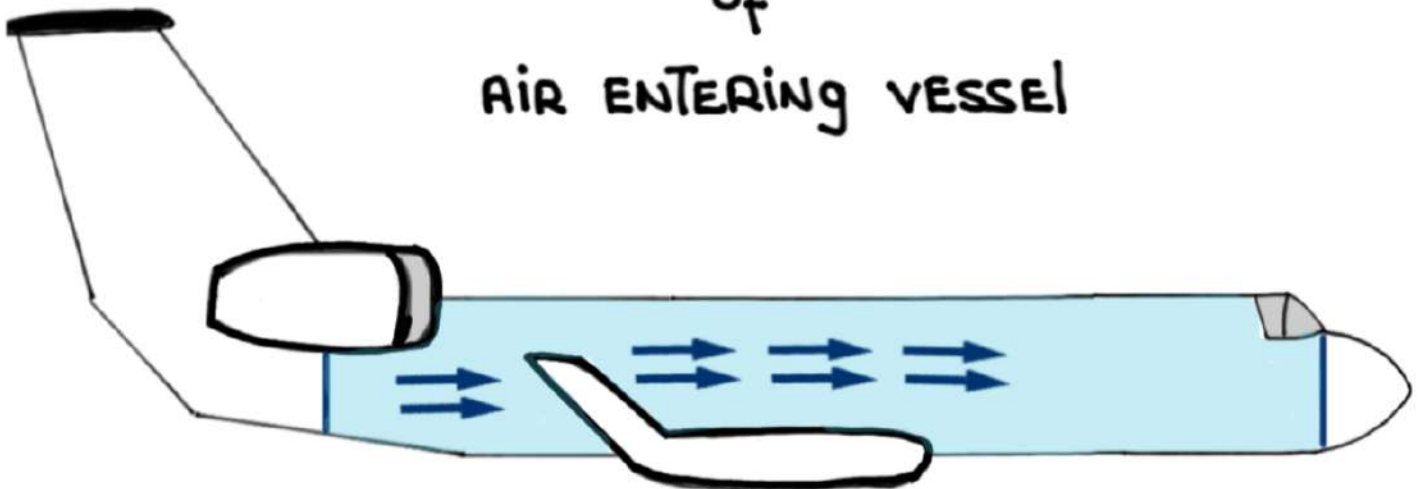

PRESSURIZATION SYSTEM

CONTROLS

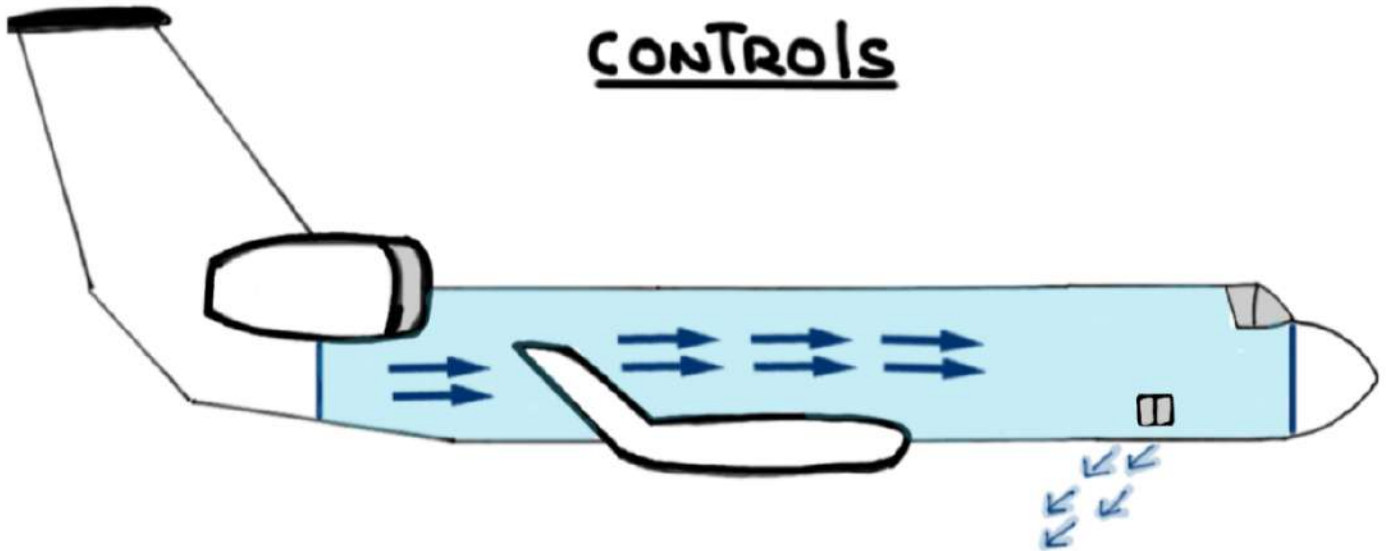

CABIN AIR EXITING VESSEL VIA:

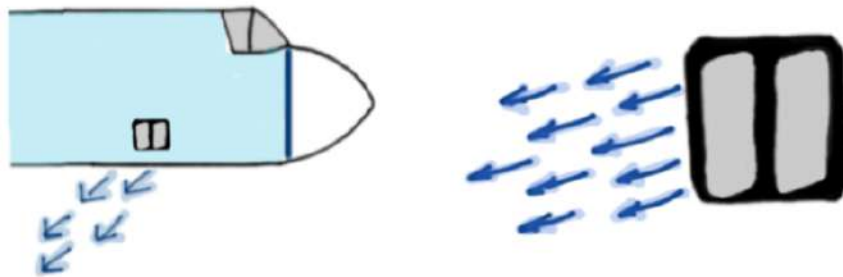

THRUST RECOVERY
OUTFLOW VALVE
(TROV)

IN ORDER TO ACHIEVE
OPTIMUM CABIN PRESSURE

The Air Conditioning System has THREE (3) MAIN functions:

① Airflow control for use by THE PRESSURIZATION SYSTEM

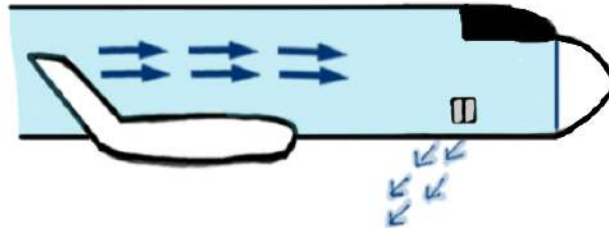

② CABIN AND COCKPIT TEMPERATURE CONTROL

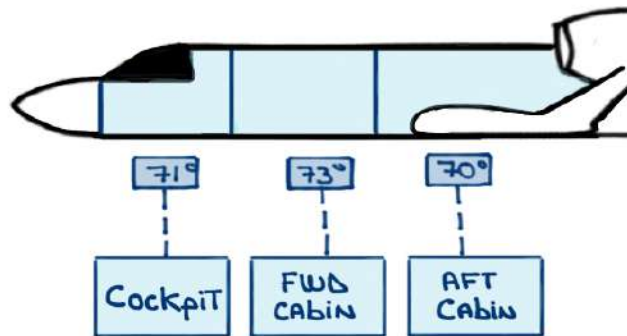

③ EQUIPMENT COOLING

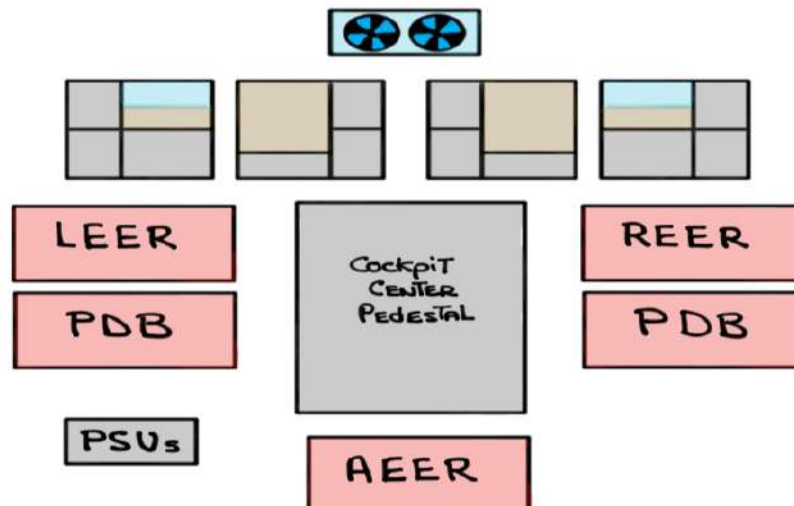

Two (2) IDENTICAL AND INTERCHANGEABLE MICROPROCESSORS, THE AIR CONDITIONING CONTROLLERS (ACC), MAKE ALL THE LOGICAL DECISIONS ASSOCIATED WITH THE AIR CONDITIONING SYSTEM



They ARE LOCATED IN THE AEER NEXT TO THE BLEED AIR CONTROLLERS

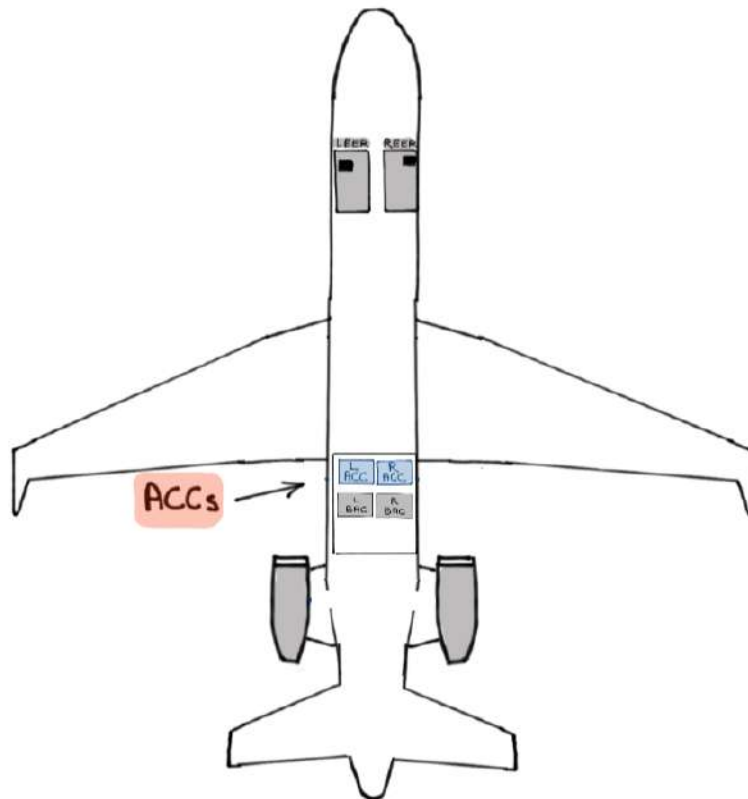
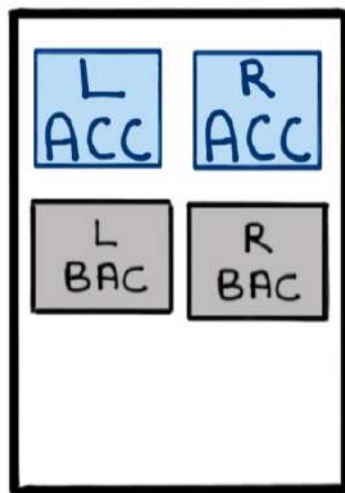

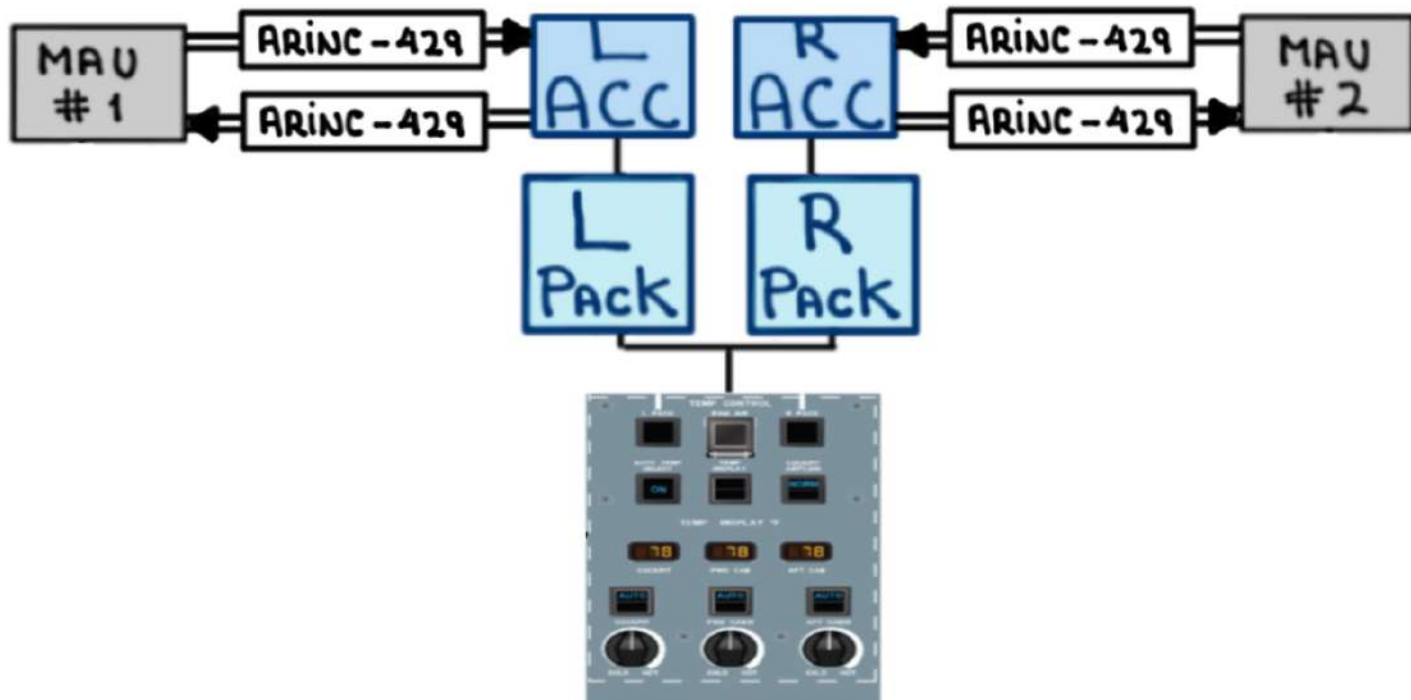

PRODUCE CONTROL

Cool, CONDITIONED, AND dehumidified AIR

Cockpit / CABIN TEMPERATURE

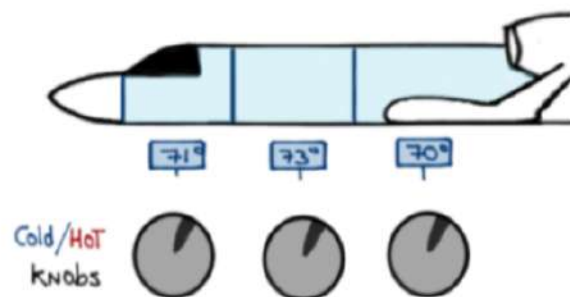
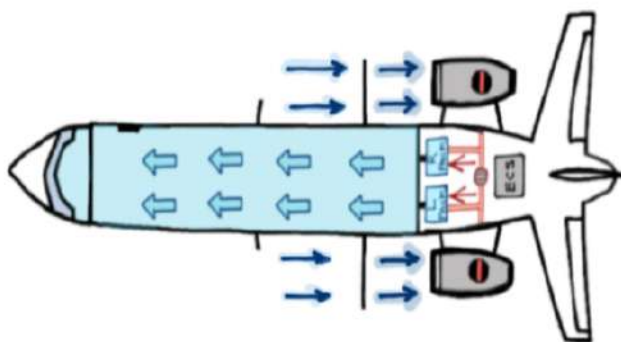

R ACC = Cockpit only

L ACC = FWD/AFT CABIN

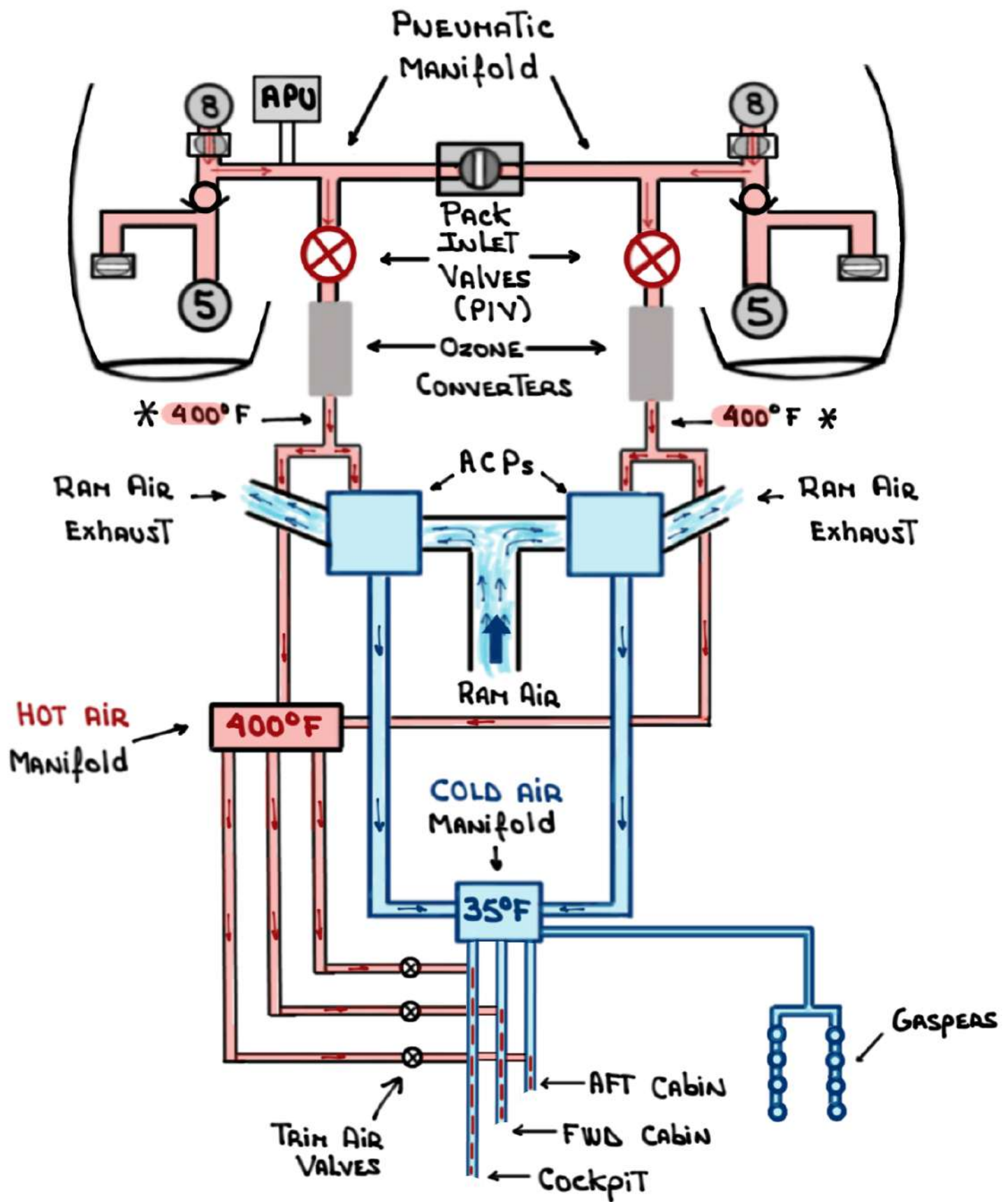

* 500°F if single pack OR single wing anti-ice operation

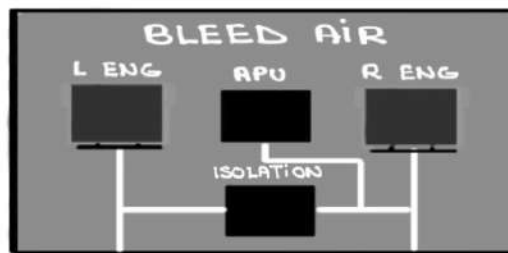

The PNEUMATIC SYSTEM provides **High PRESSURE** and **High TEMPERATURE** AIR VIA THE PNEUMATIC MANIFOLD

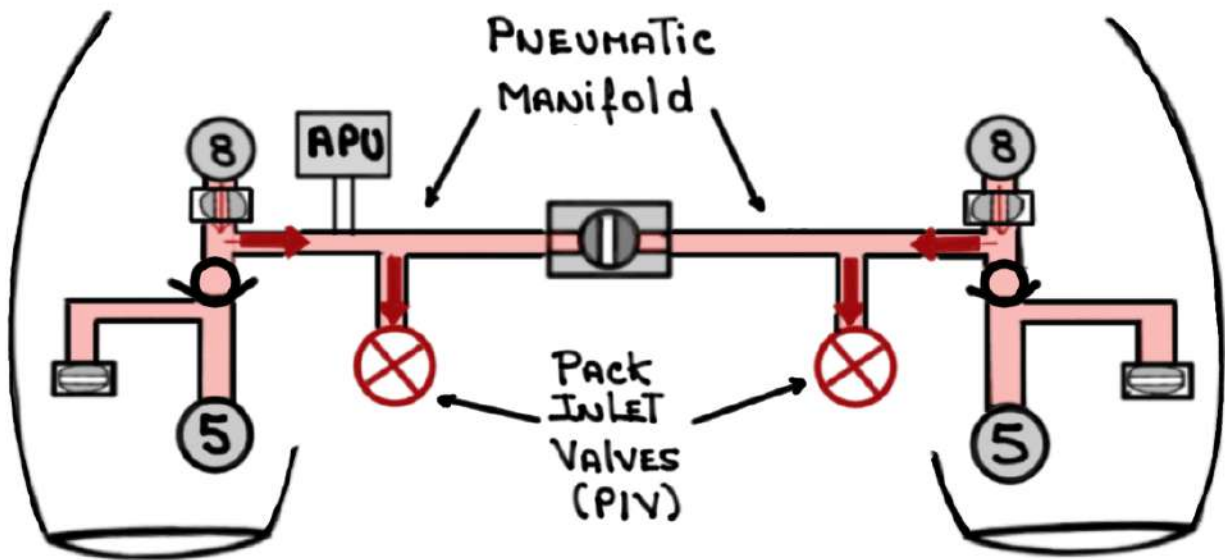

THE PACK INLET VALVES (PIV) ALLOW AIR FROM THE RESPECTIVE LEFT OR RIGHT MANIFOLD TO ENTER THE AIR CONDITIONING SYSTEM

THE PIVS ARE ELECTRICALLY-CONTROLLED AND PNEUMATICALLY-OPERATED. THEY ARE SPRING-LOADED TO BE FAILSAFE OPEN

THE PIVS CAN BE MANUALLY OPEN OR CLOSED USING THE RESPECTIVE PACK SWITCH ON THE TEMPERATURE CONTROL PANEL

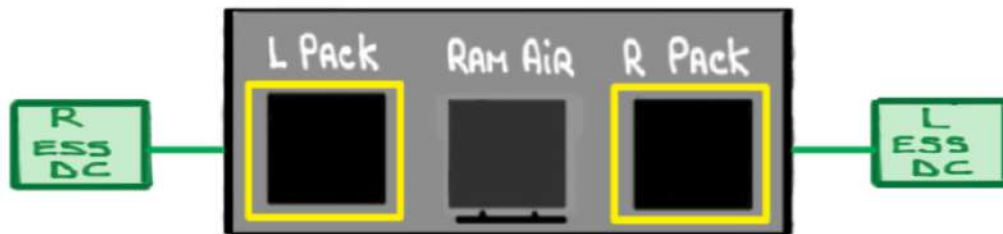

WHEN THE PIVS ARE COMMANDED OPEN THE L
ACC R
ACC CONTROL THEIR RESPECTIVE PACK VALVE TO MODULATE THE AIRFLOW BASED ON CONDITIONS AND REQUIREMENTS

OZONE CONVERTERS REMOVE POSSIBLE HIGH CONCENTRATIONS OF OZONE BY CONVERTING OZONE (O_3) TO OXYGEN (O_2) TO ENHANCE PASSENGER COMFORT



Air flows Through The PIVs AND divides INTO Two (2) SEPARATE flows:

1. Air Conditioning Pack (ACP), AND
2. HOT AIR MANIFOLD

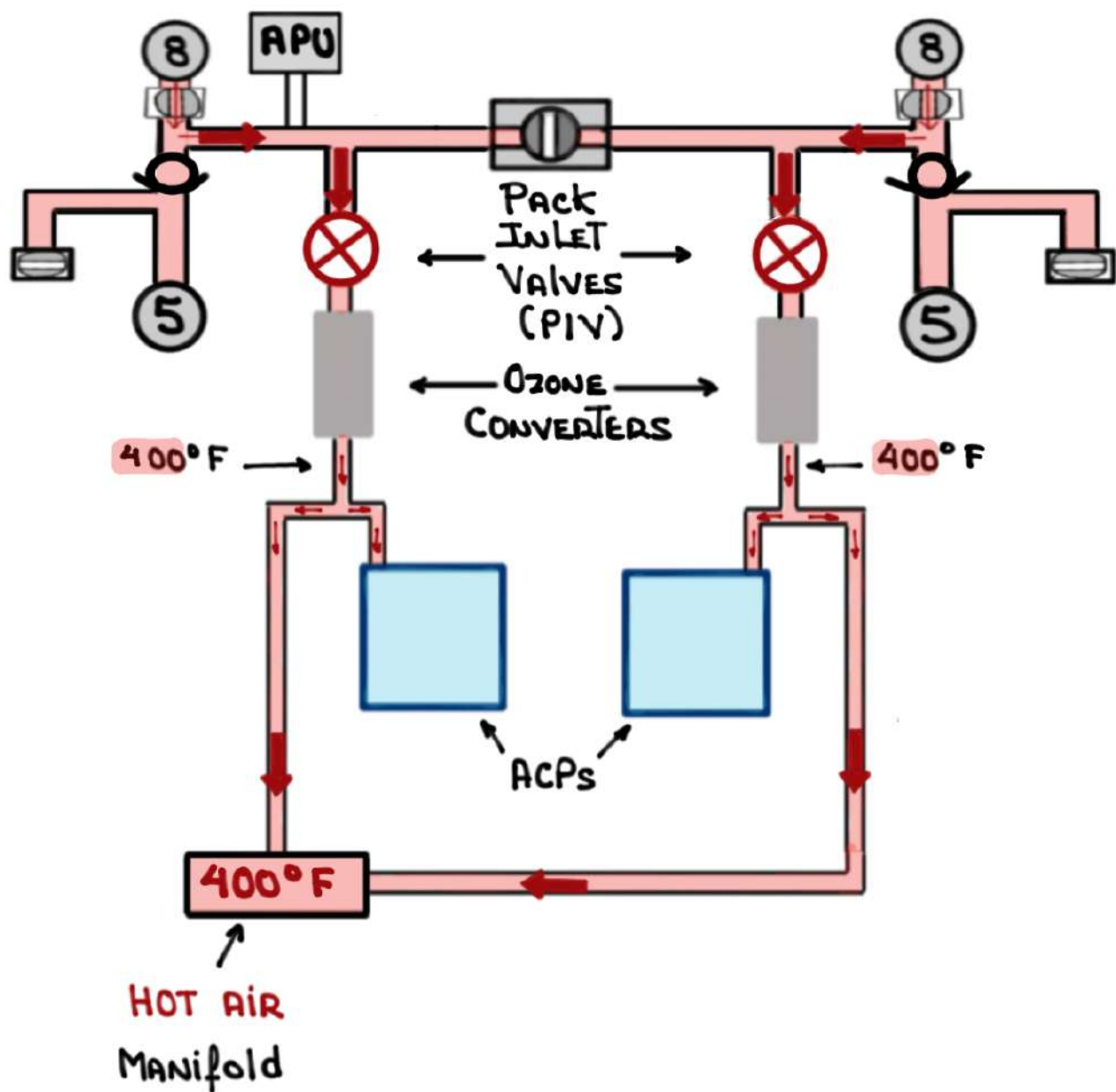

The **L Pack** **R Pack** ARE IDENTICAL AND ARE LOCATED IN THE TAIL COMPARTMENT

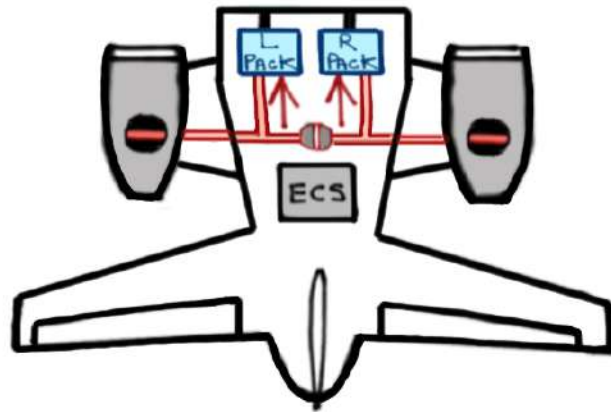

They ARE PNEUMATICALLY-POWERED by High PRESSURE AND High TEMPERATURE AIR (5TH OR 8TH STAGE BLEED AIR OR APU BLEED AIR)

They PRODUCE COOL, CONDITIONED AND DEHUMIDIFIED AIR

Each ACP is MONITORED AND CONTROLLED by THEIR RESPECTIVE AIR CONDITIONING CONTROLLER (ACC)



Air THAT ENTERS THE ACPs IS COOLED DOWN TO **35°F** AND SUPPLIED TO THE COLD AIR MANIFOLD

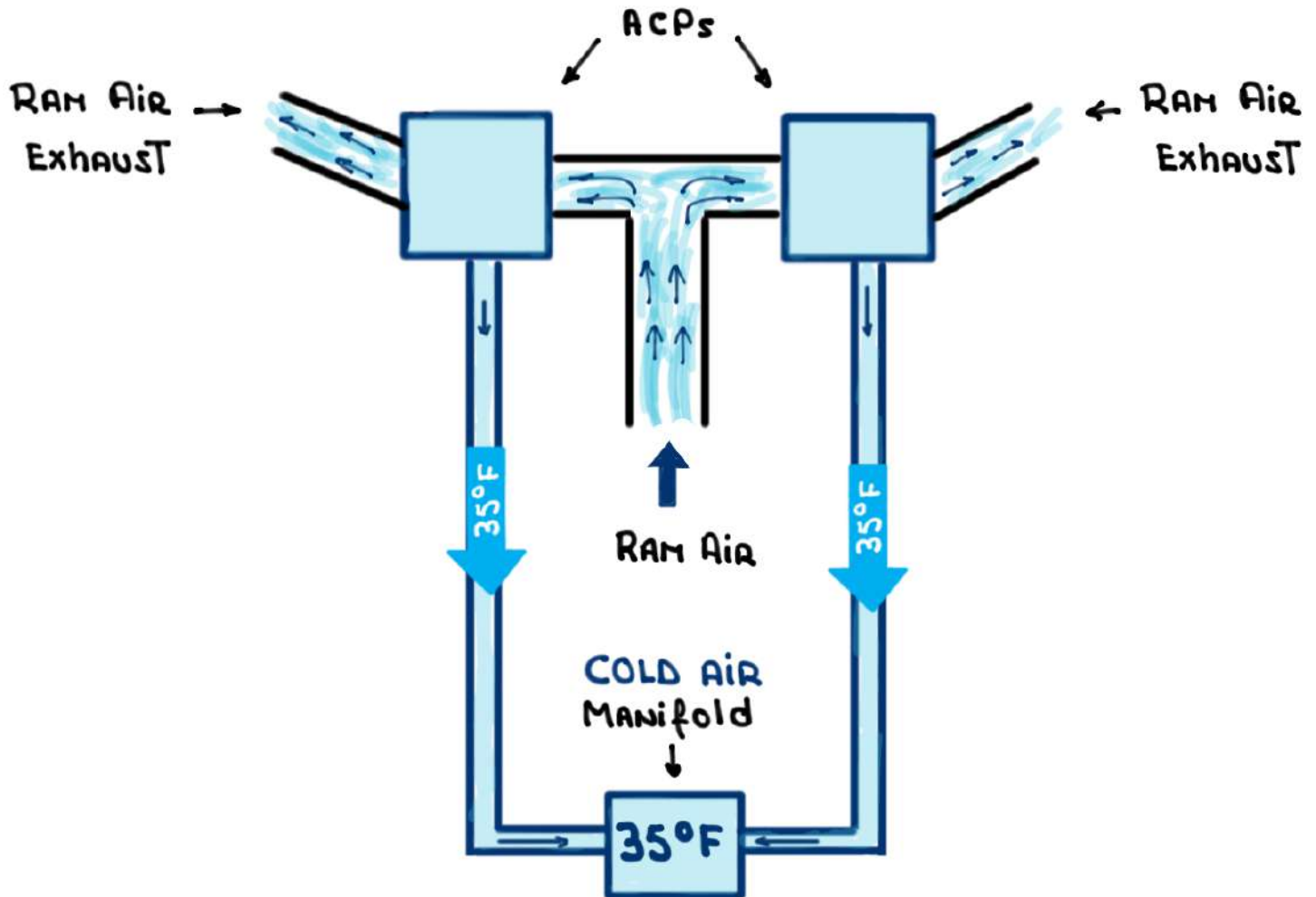

To cool the supplied bleed air the ACPs use a combination of:

- AN AIR CYCLE MACHINE (COOLING TURBINE), AND
- A HEAT EXCHANGER

- Air Cycle Machine (ACM):

The ACM, Together with The Heat Exchangers, is a sub component of The ACP

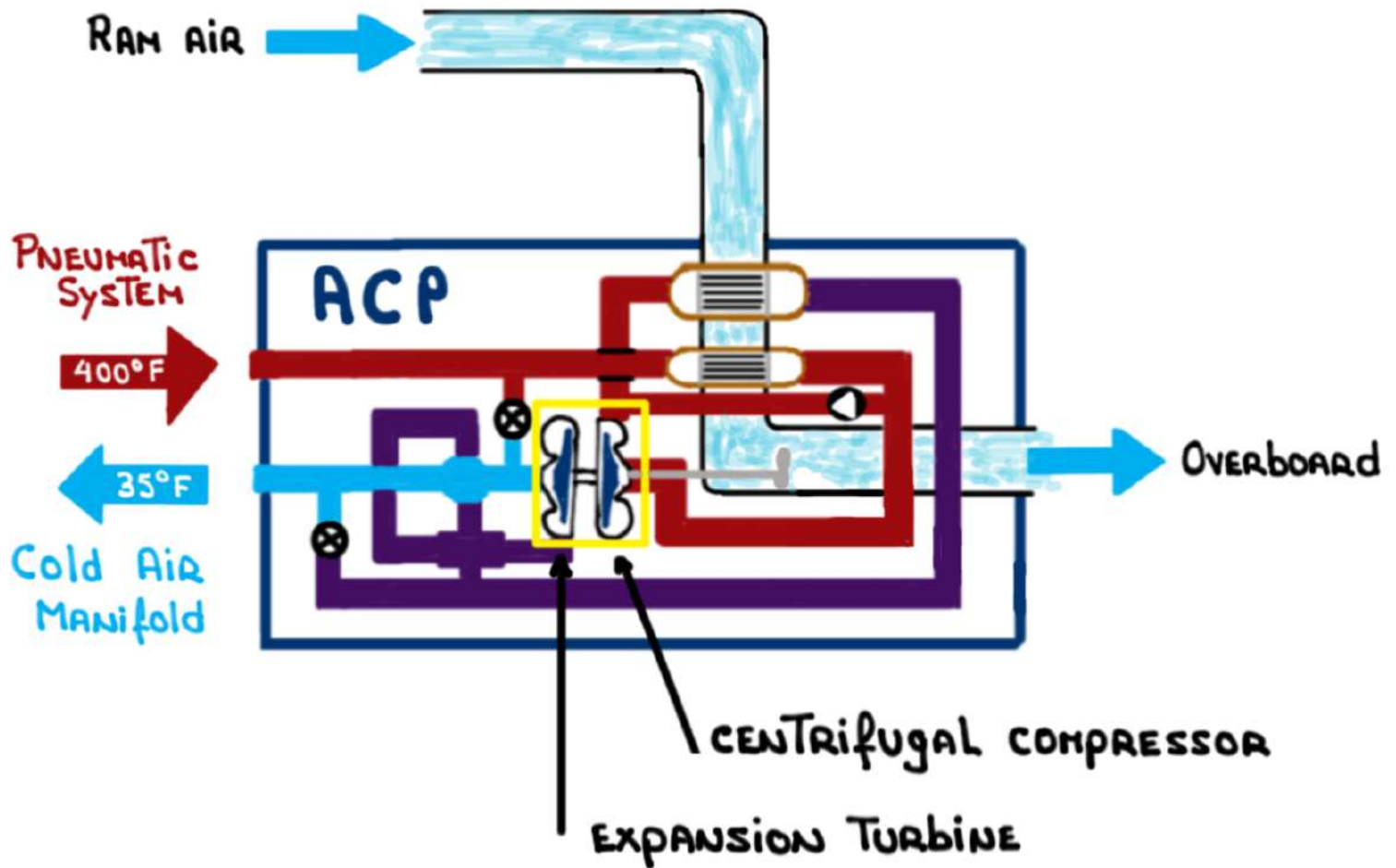

AN ACM IS AN OPEN CYCLE SYSTEM THAT USES AIR AS COOLING AGENT (NO FREON OR ANY OTHER TYPE OF REFRIGERANT IS USED)

BLEED AIR FROM THE ENGINES OR THE APU IS DIRECTED TO THE PRIMARY HEAT EXCHANGER. OUTSIDE AIR AT AMBIENT TEMPERATURE IS USED TO COOL THE BLEED AIR

THE COOLED BLEED AIR IS THEN ROUTED TO THE CENTRIFUGAL COMPRESSOR WHICH COMPRESSES IT RAISING ITS TEMPERATURE

THE COMPRESSED HEATED AIR IS THEN ROUTED TO THE SECONDARY HEAT EXCHANGER FOR COOLING

THE COMPRESSED, COOLED AIR IS THEN ROUTED TO THE TURBINE WHICH EXTRACTS HEAT AS THE AIR EXPANDS

THE TURBINE DRIVES THE COMPRESSOR VIA A SHAFT AND THE COMPRESSOR DRIVES THE PLENUM FAN

THE COOLED AIR IS THEN DEHUMIDIFIED BY A WATER EXTRACTOR WHICH SPRAYS THE CONDENSATION INTO THE HEAT EXCHANGER DUCT FURTHERING THE COOLING PROCESS

- AIR-TO-AIR HEAT EXCHANGERS:

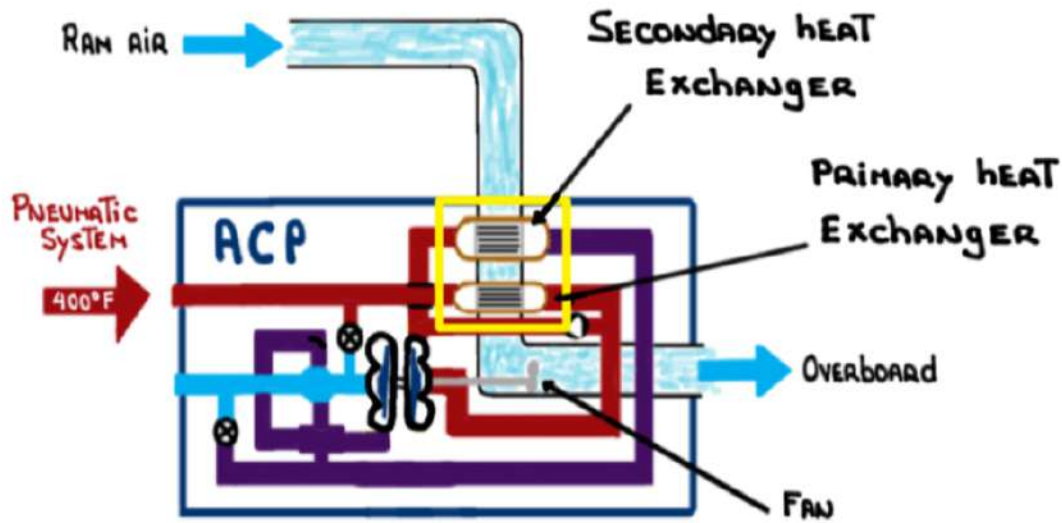

Outside air is forced into dorsal fin scoop while in flight. This air is DELIVERED via a dual-ducted plenum to the ACPs' primary and secondary heat exchangers

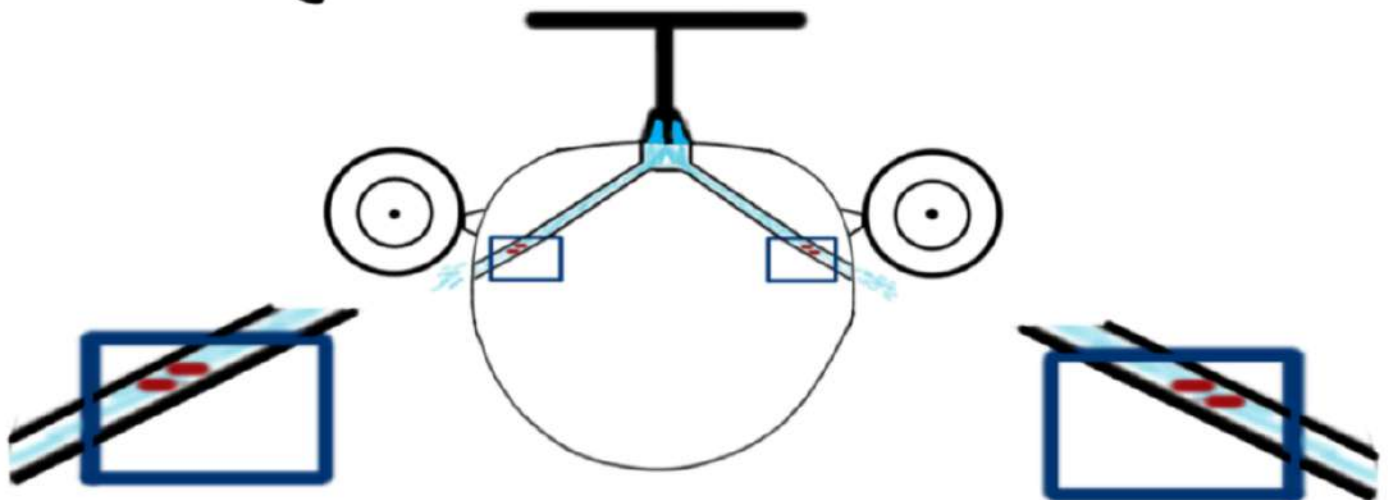

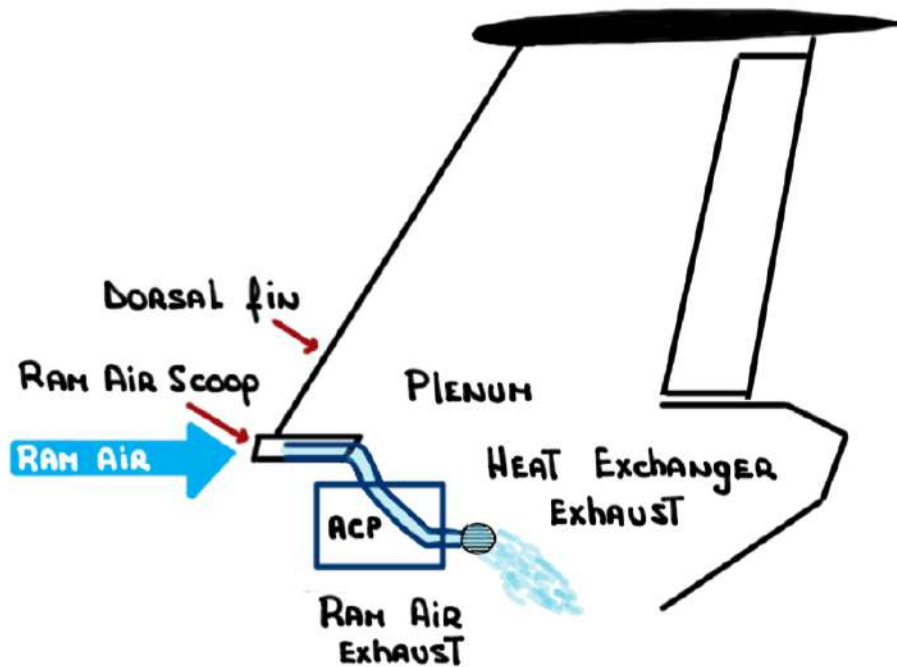

AFTER flowing by THE HEAT EXCHANGERS THE airflow is VENTED OVERBOARD THROUGH EXHAUST PORTS LOCATED ON THE AFT side of THE fuselage

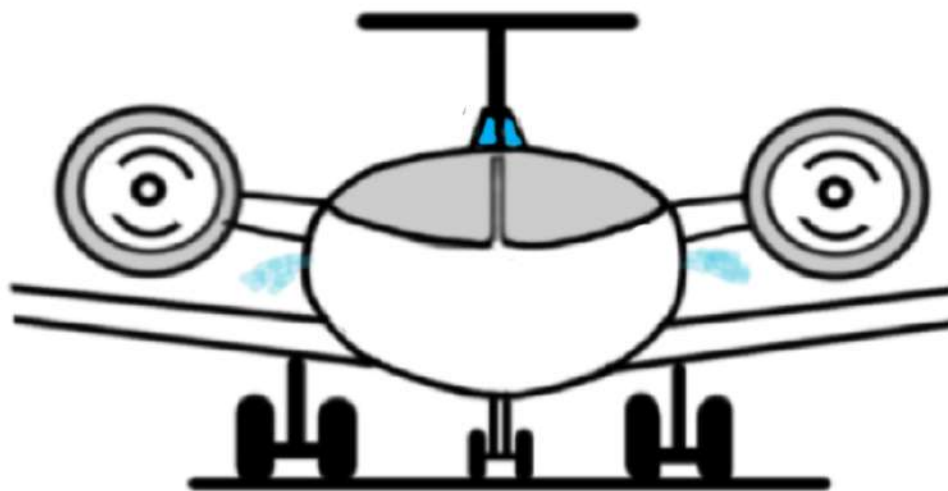

DURING **ground** operations cooling airflow TO THE HEAT EXCHANGER IS CREATED by a fan. THE fan IS DRIVEN by THE COMPRESSOR SECTION of THE ACM

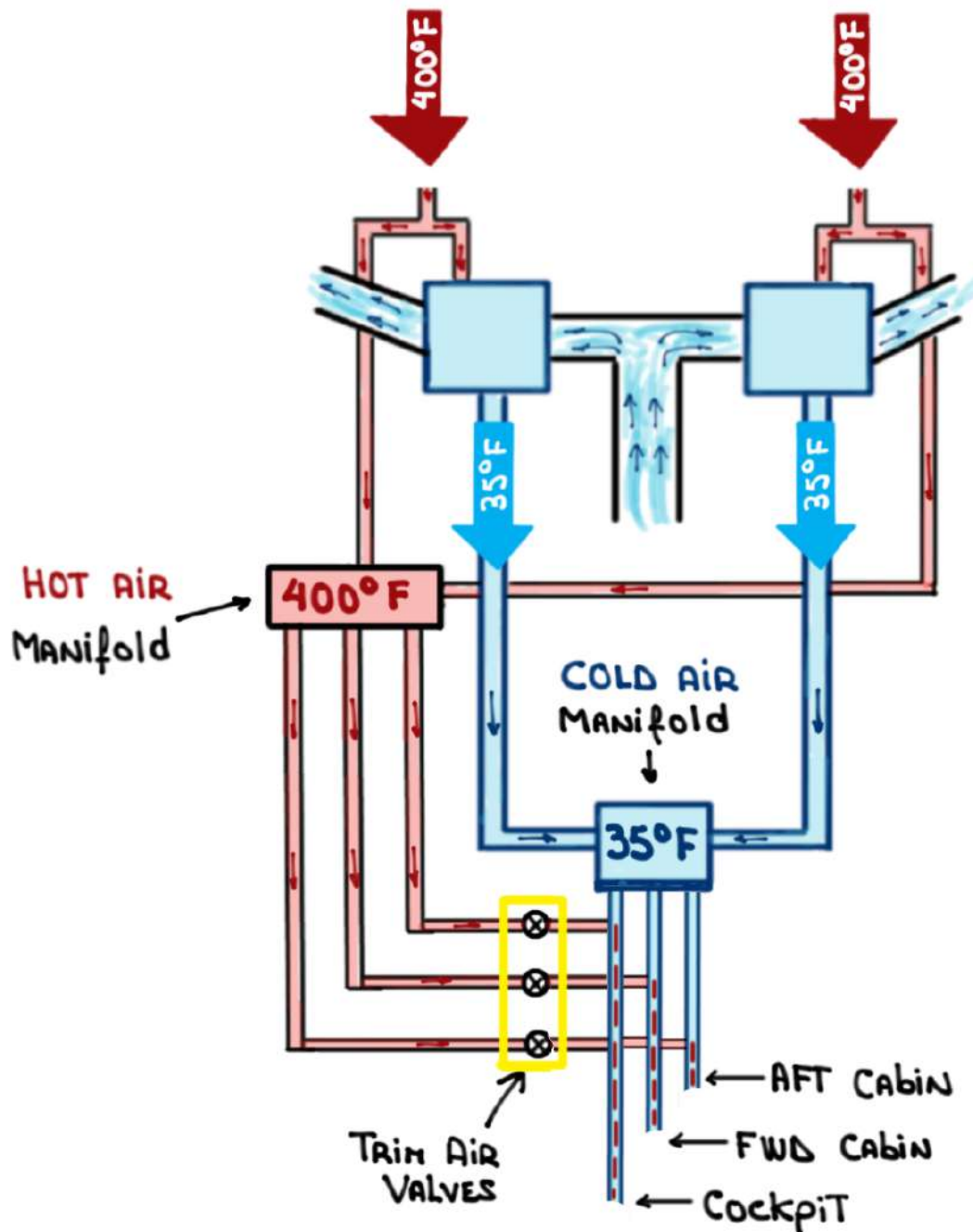

THE TRIM AIR VALVES ARE MODULATED, EITHER MANUALLY OR AUTOMATICALLY, TO MIX **TRIM AIR MANIFOLD** AIR (400°F) WITH AIR FROM THE COMMON **COLD AIR MANIFOLD** (35°F) IN ORDER TO OBTAIN THE DESIRED ZONE TEMPERATURE

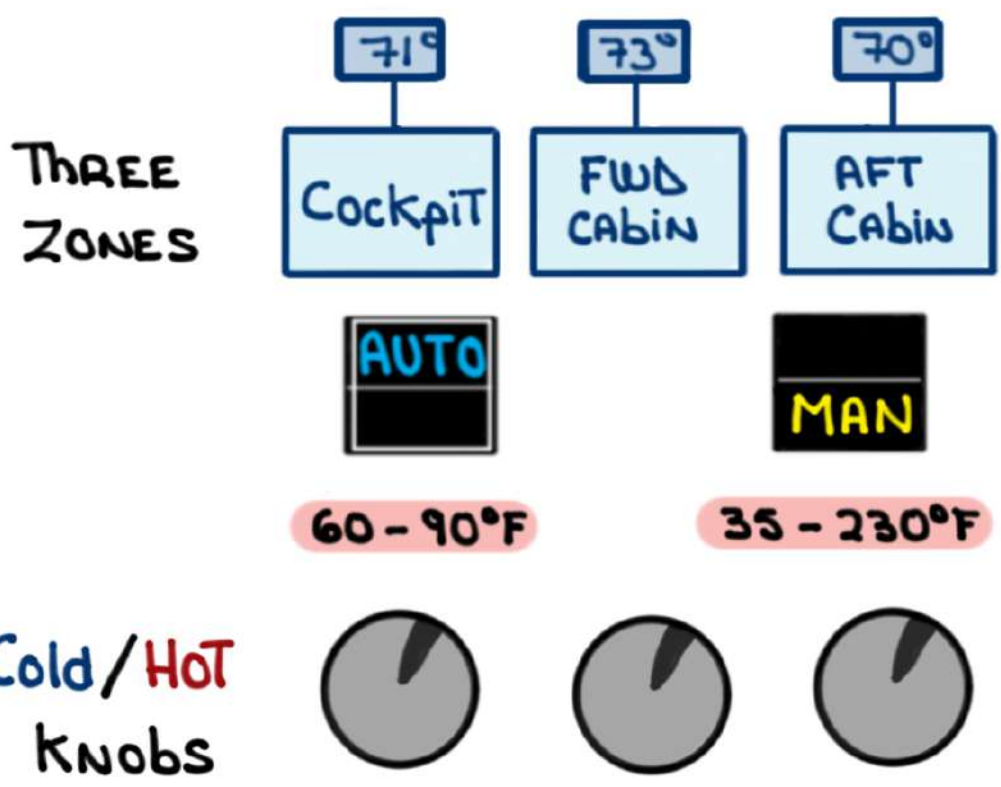
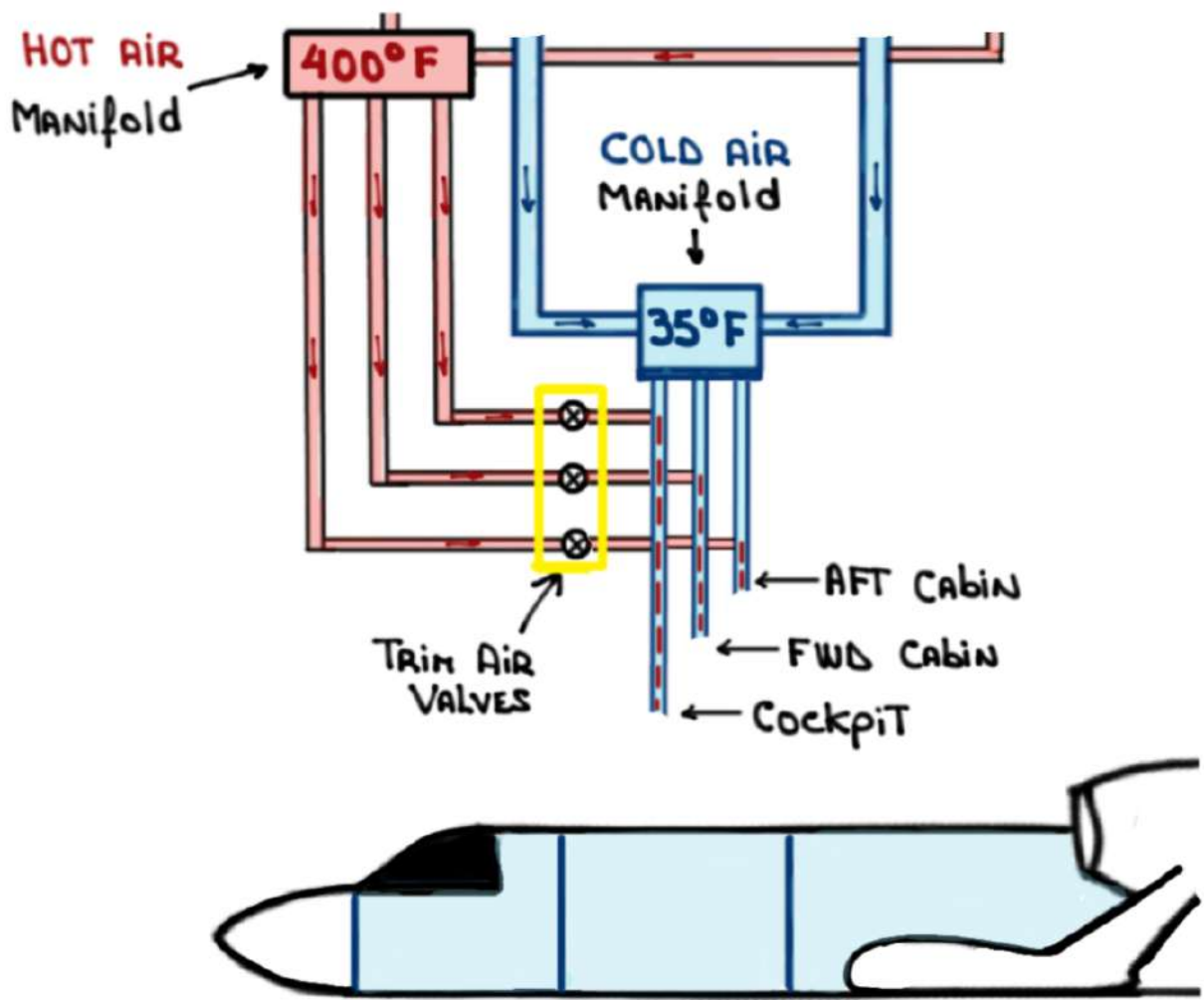

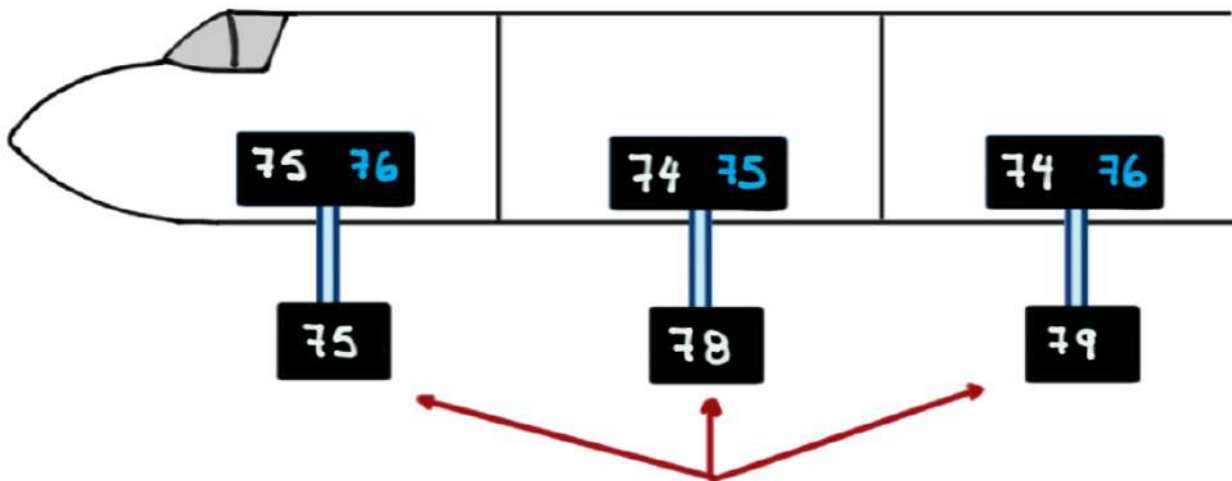

Supply DUCT TEMPERATURE

SELECTED TARGET TEMPERATURE

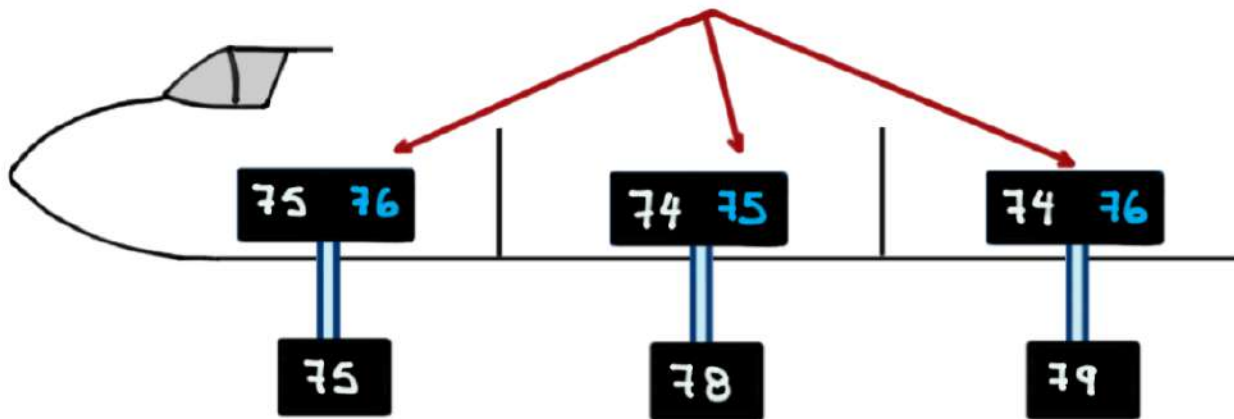

ACTUAL ZONE TEMPERATURE

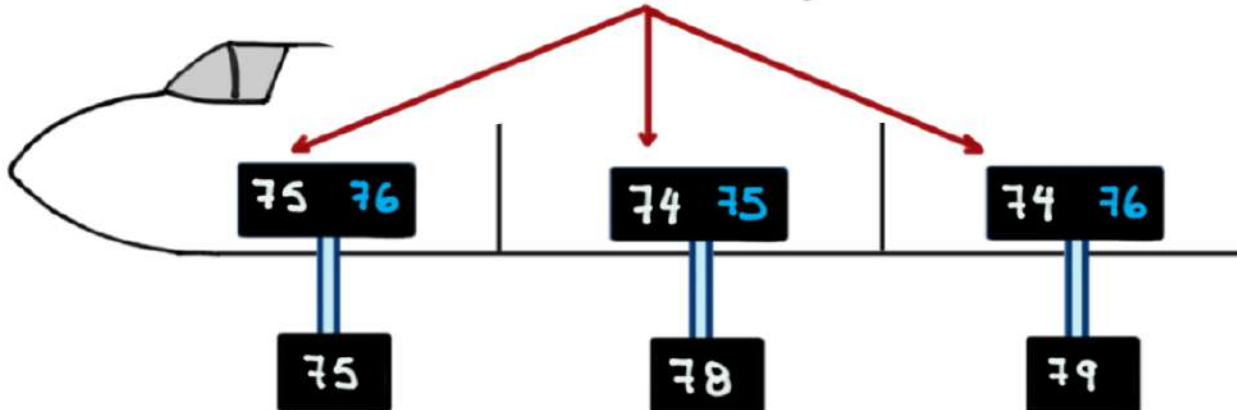

ENGINE START

SELECTING THE CRANK MASTER OR START MASTER TO **ON**
TURNS THE R PACK **OFF**



SELECTING EITHER THE L ENG OR R ENG SWITCHLIGHT
TO **ON** TURNS THE L PACK **OFF**

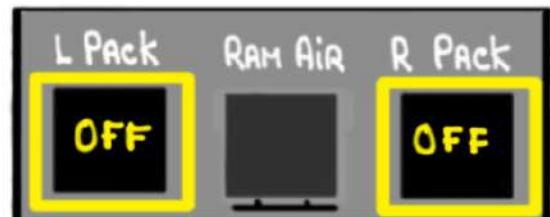

This MAXIMIZES AVAILABLE AIRFLOW TO THE AIR
TURBINE STARTER (ATS) DURING ENGINE START

As EACH ENGINE START SEQUENCE is COMPLETED
THE L PACK COMES ON

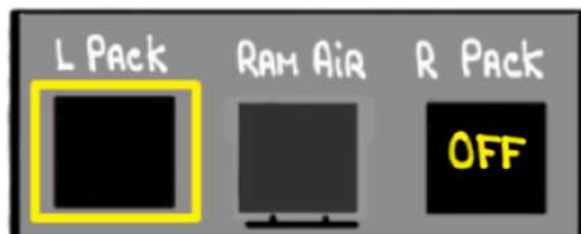

When The CRANK MASTER OR START MASTER is DESELECTED The R Pack COMES ON



RAM Air Switch

When RAM Air is selected ON both PACKS ARE TURNED OFF AND THE PIVS CLOSE

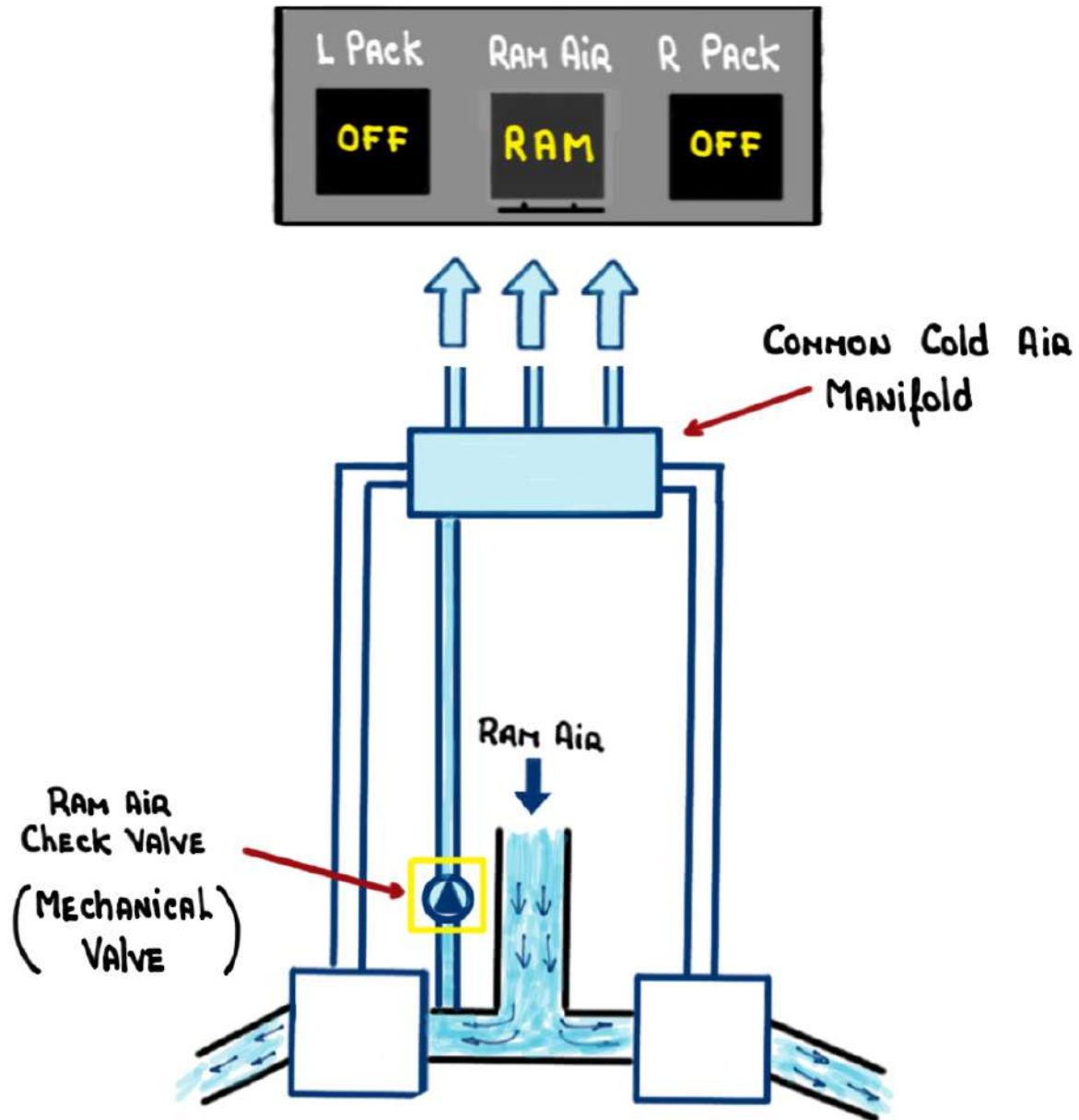

The check valve opens only when RAM air PRESSURE is GREATER THAN CABIN AIR PRESSURE

RAM AIR PRESSURE > CABIN AIR PRESSURE

RAM AIR SELECTED ON

ΔP
High-To-Low



RAM AIR VALVE
OPEN

RAM AIR VALVE
CLOSE



CONDITIONS THAT MAY REQUIRE ITS USE:

- OVERPRESSURIZATION DUE TO LOSS OF SYSTEM CONTROL
- SMOKE REMOVAL FROM THE AIRCRAFT INTERIOR
- DITCHING OVER WATER

EQUIPMENT COOLING Sub-system

The ACPs provide airflow to equipment cooling fans  for various sections of the aircraft that house electronic equipment in order to dissipate **HEAT**

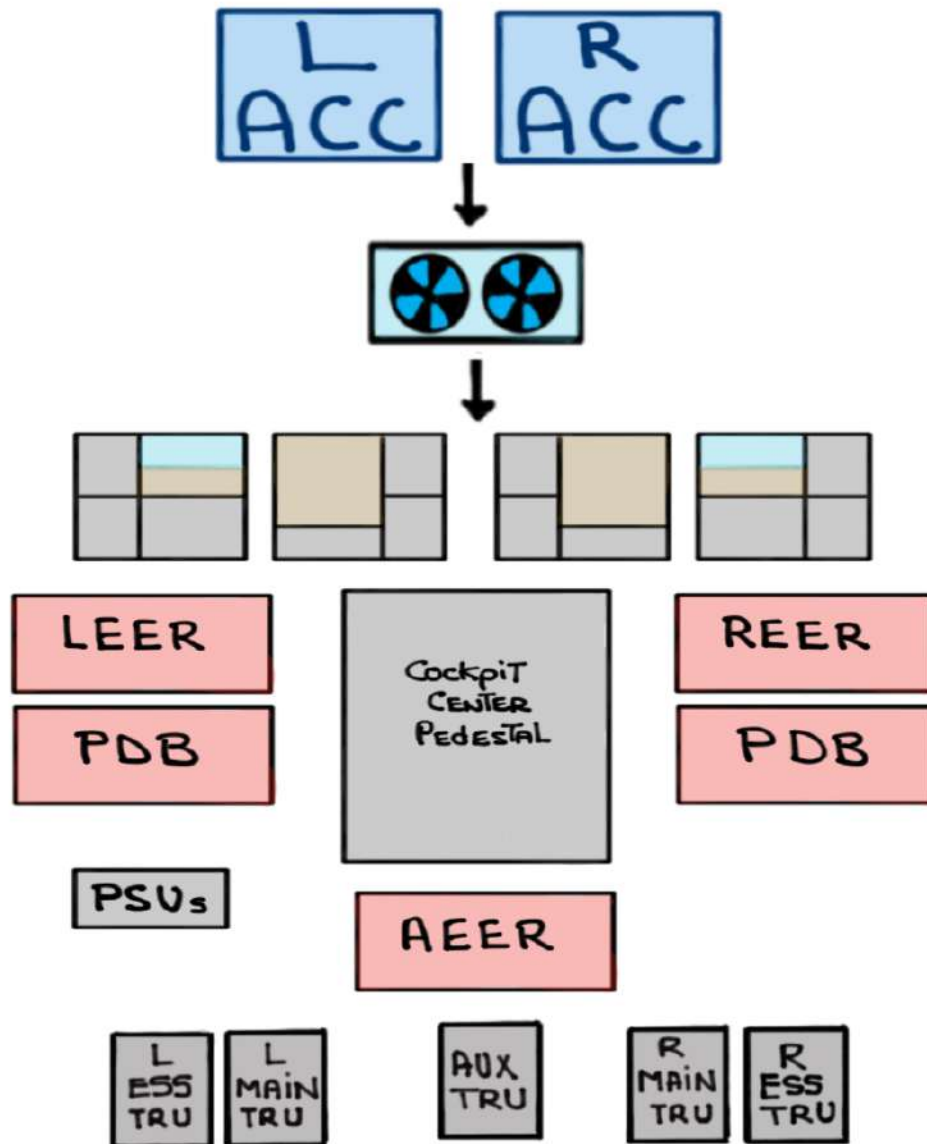

LEER
REER
POB

PERSONAL
SERVICE
UNITS
(PSU)

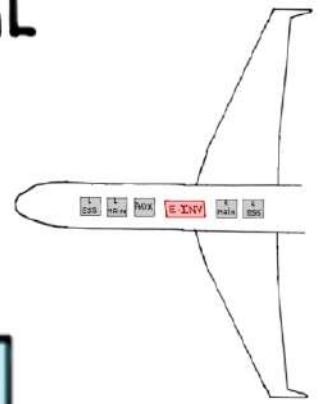

(POWER DISTRIBUTION BUS)

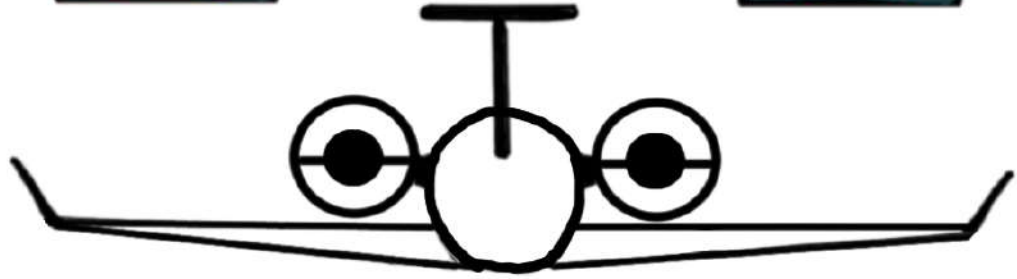

Low speed

High speed

> 35,000'



< 35,000'

High speed

Low speed

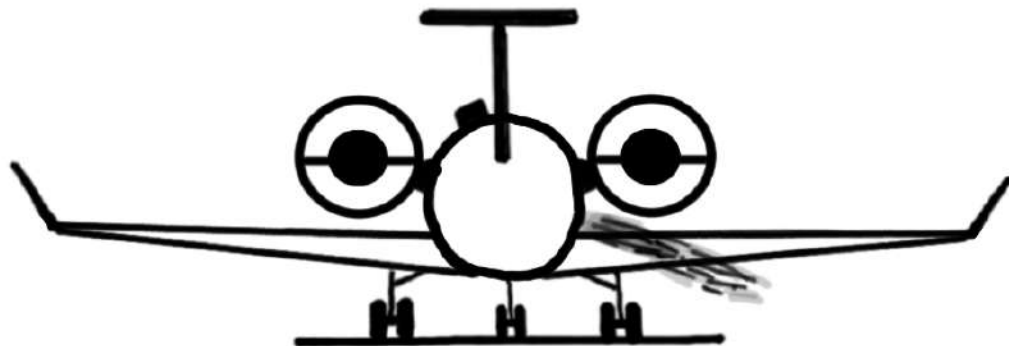

SINGLE ACP OPERATIONS

① MAXIMUM ALTITUDE

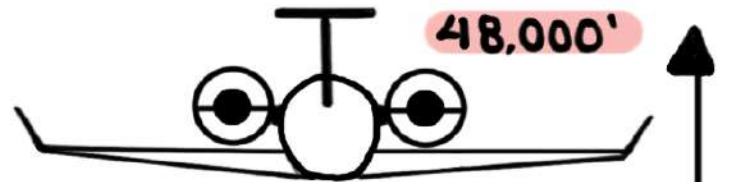

② INTERNAL BAGGAGE DOOR OPENING



③ BLEED AIR MANIFOLD SET POINT $35 \text{ psi} \pm 3$

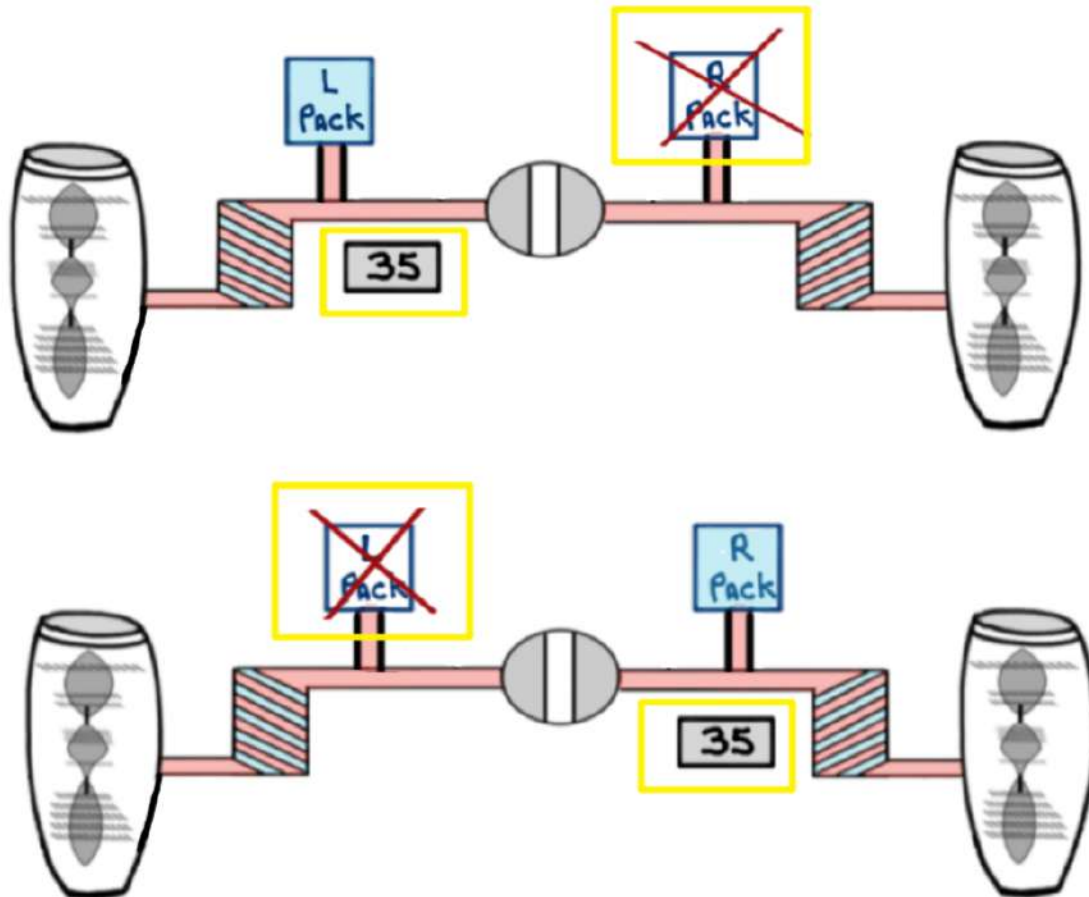

REMINDER: these system notes are intended for study purposes only. Always refer to official Gulfstream manuals and other approved references when operating your aircraft.

NOTE: these system notes are updated from time to time and what is posted on Code450.com will always be the most recent version.

Questions, comments or errors...please do send me an email:
ivan@code7700.com

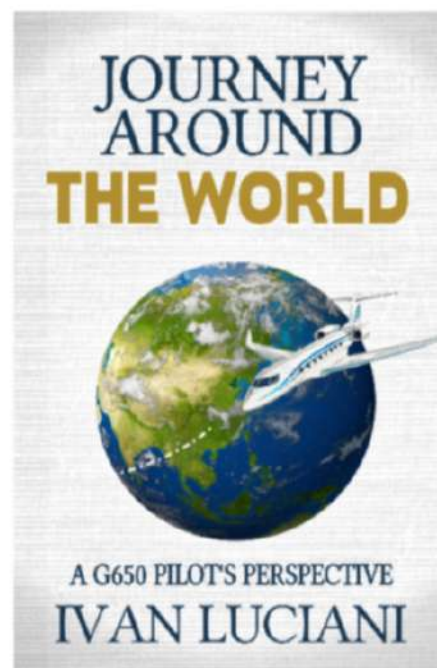
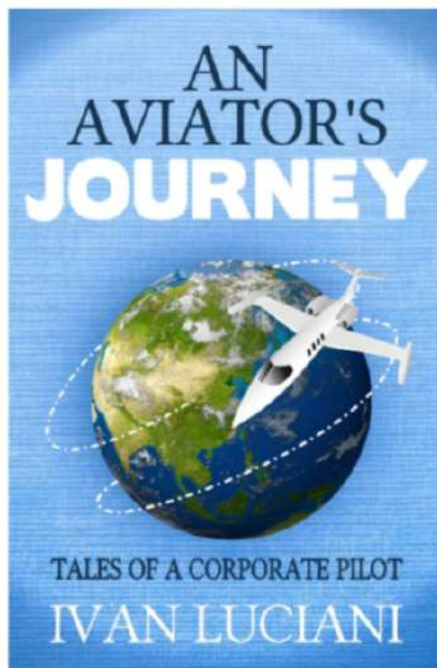

Thank you!