

# G550 OXYGEN SYSTEM

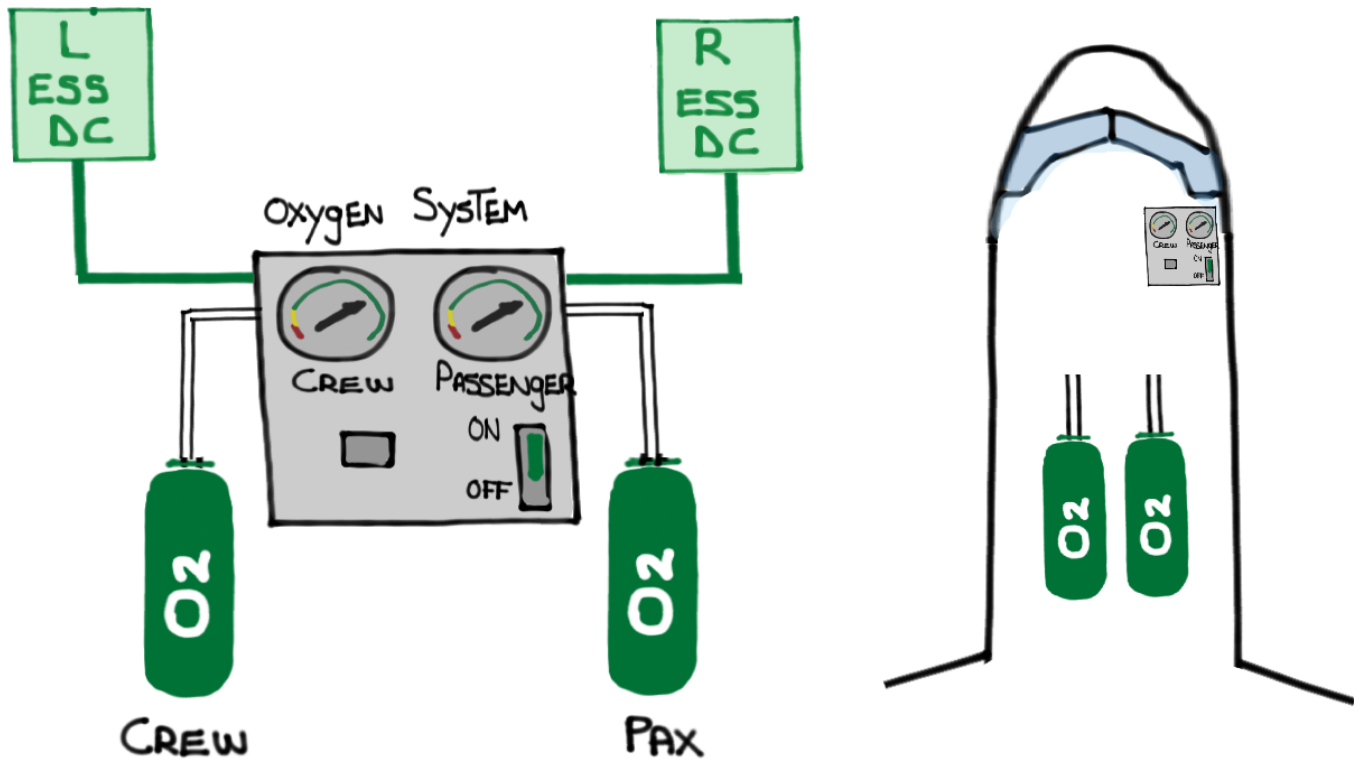

For study purposes only

The Oxygen System is about the STORAGE of gaseous oxygen under high pressure and its delivery to crew and passengers as an alternate means of breathing in the event of:

IN THE EVENT of:

- DEPRESSURIZATION
- SMOKE/FUMES

- Two (2) identical tanks are plumbed together to form a single system

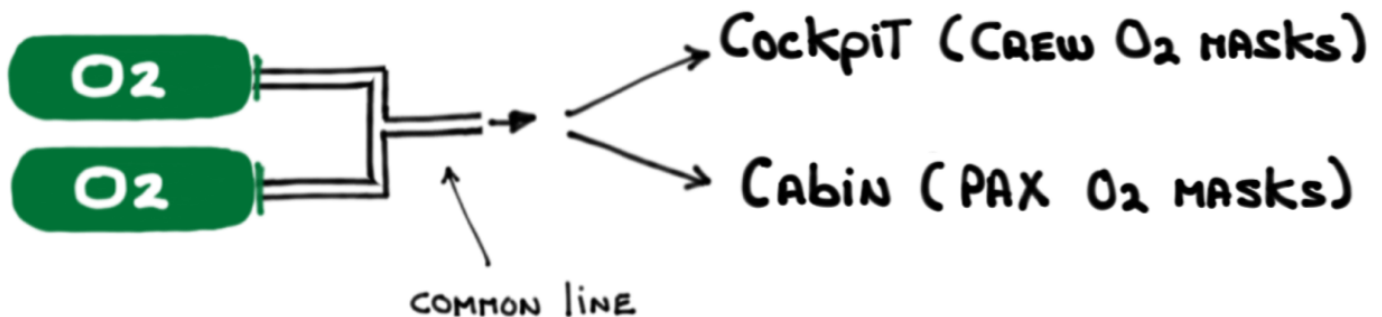

- The  TANKS HAVE A CAPACITY OF 123.4 ft<sup>3</sup> AND ARE PRESSURIZED TO 1800 ± 50 psi

- Each bottle consists of an aluminum cylinder wrapped in kevlar for reinforcement

- Cylinder pressure regulators REDUCE system pressure to **55-80** psi prior to the supply line

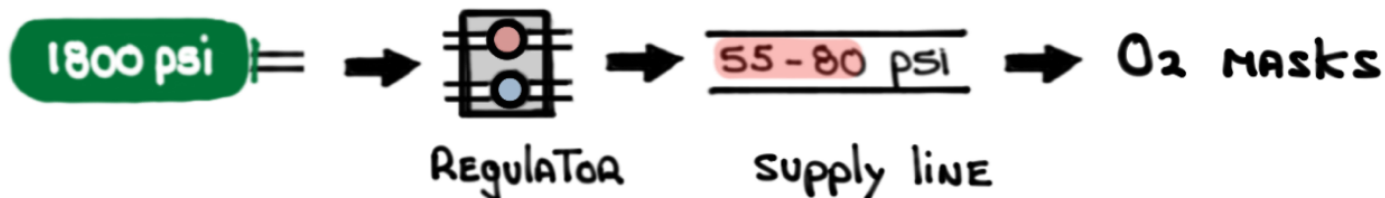

- Oxygen system pressure relief valves:

- High pressure system: > **2775** Psi  
(bottles and high pressure lines)
- Low pressure system: > **90** Psi  
(bottle's low pressure supply line)
- Thermal (temperature) relief: **225** °F

- The pressure relief ports are teed together and connected to the overboard discharge indicator on the right side of the aircraft

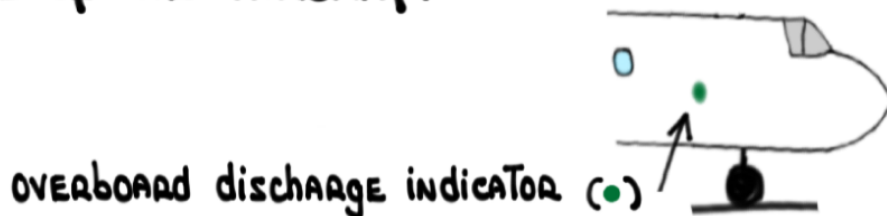

- Oxygen Tanks ARE LOCATED UNDERNEATH THE FLOOR NEAR THE MAIN ENTRANCE doorway

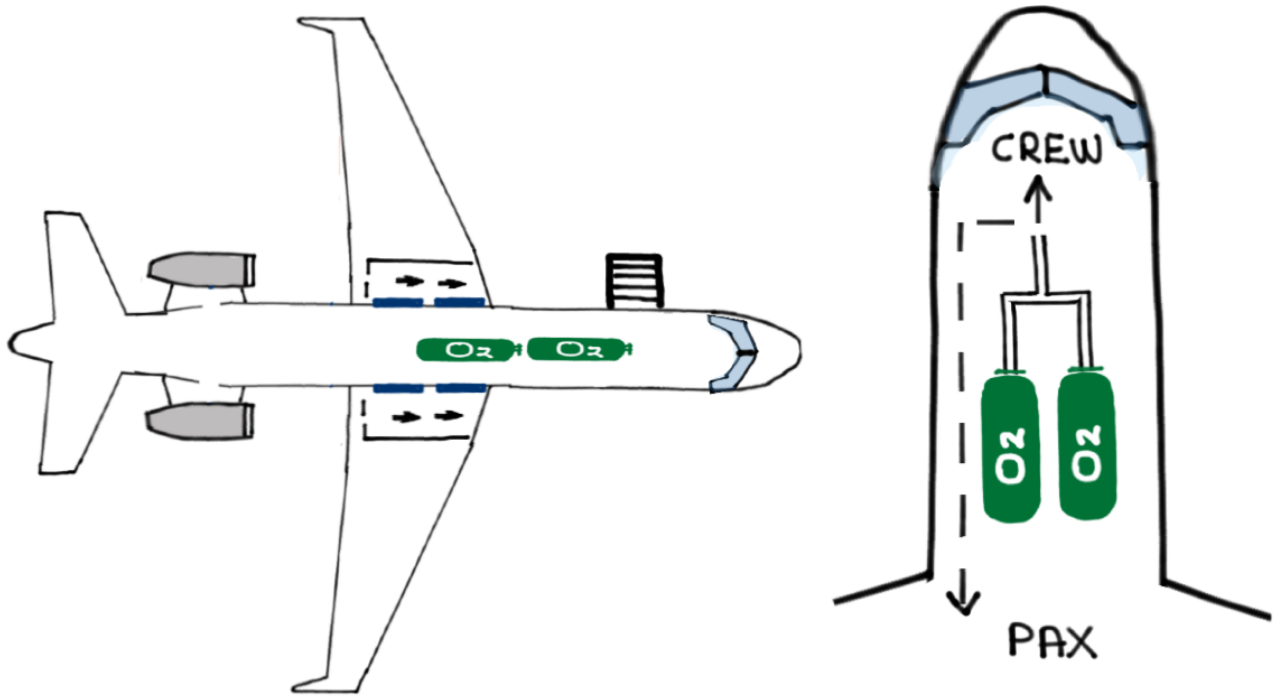

- The  TANKS ARE SERVICED THROUGH A PANEL ON THE RIGHT SIDE OF THE AIRCRAFT (MAINTENANCE FUNCTION)

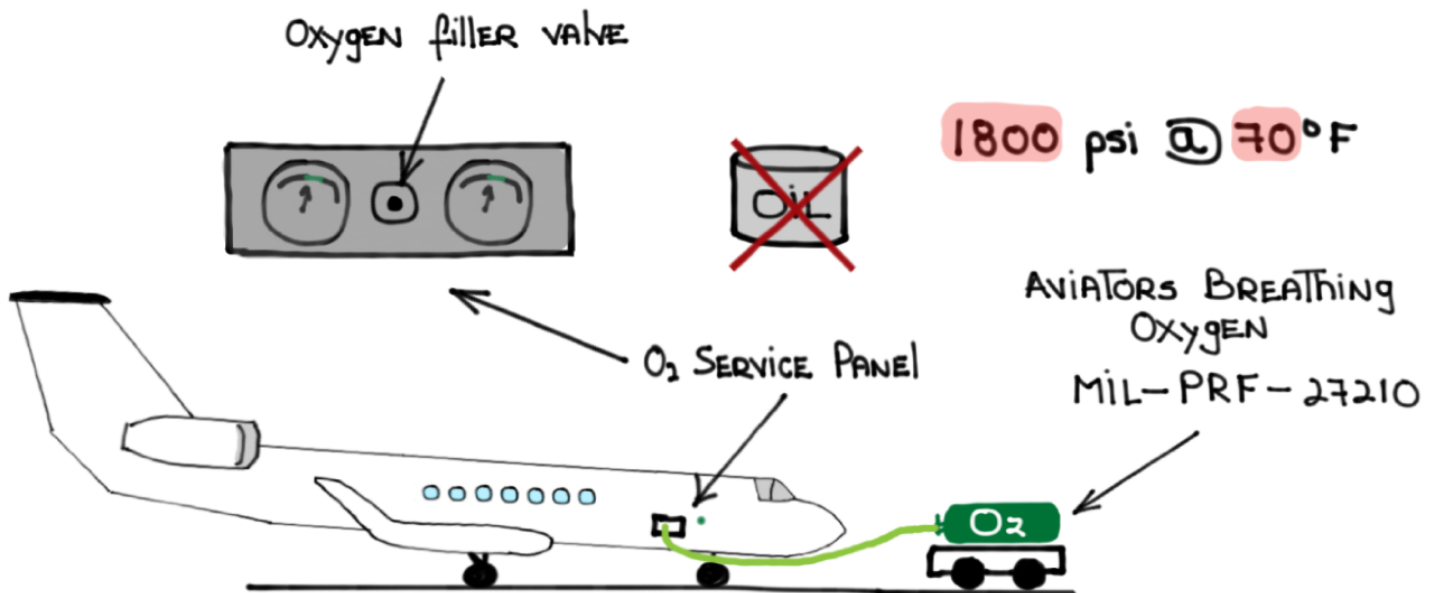

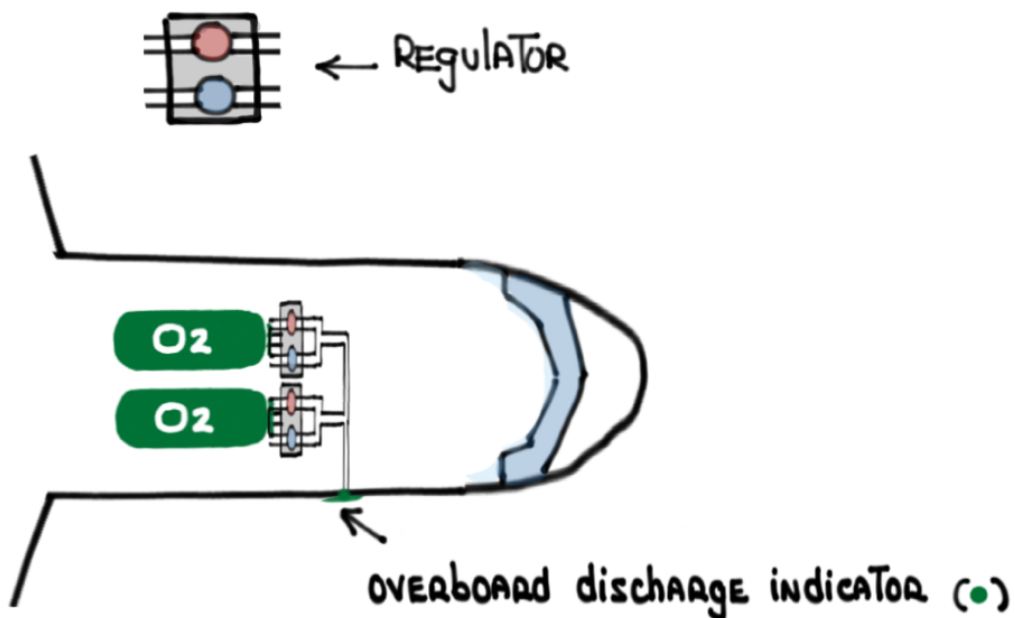
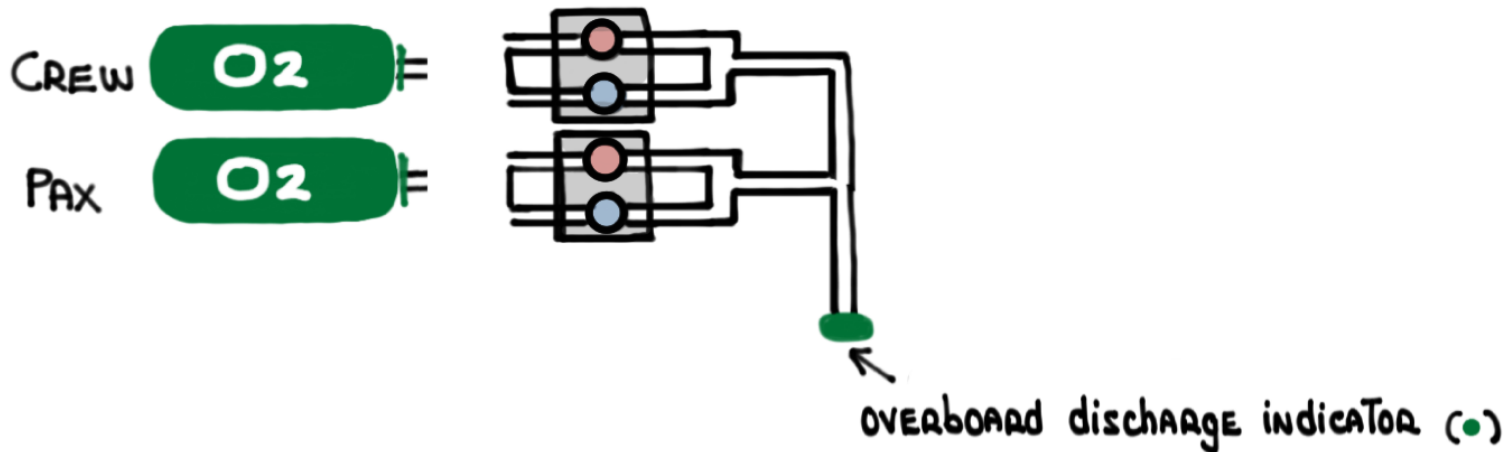

## - OVERBOARD discharge indicator - STATUS

CHECKED DURING PAE AND POST-FLIGHT INSPECTIONS

● = OK ✓

○ = DISCHARGED ✗

# Oxygen gauges

- Oxygen Service Panel - direct reading gauges

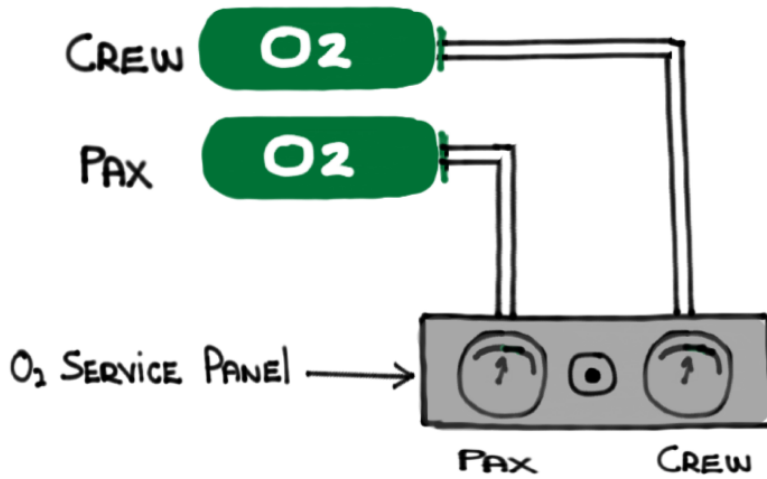

- Cockpit Oxygen System Panel

DC-POWERED

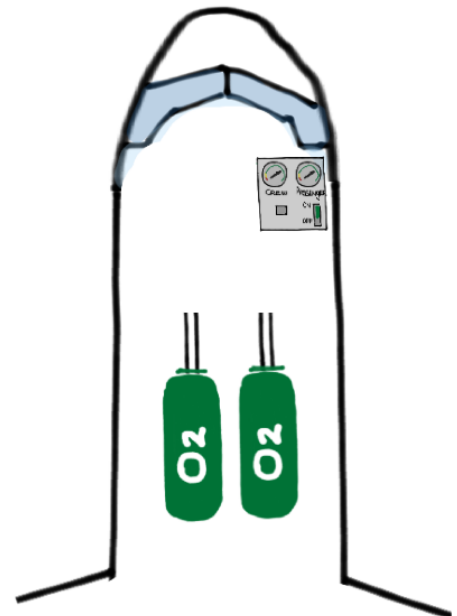
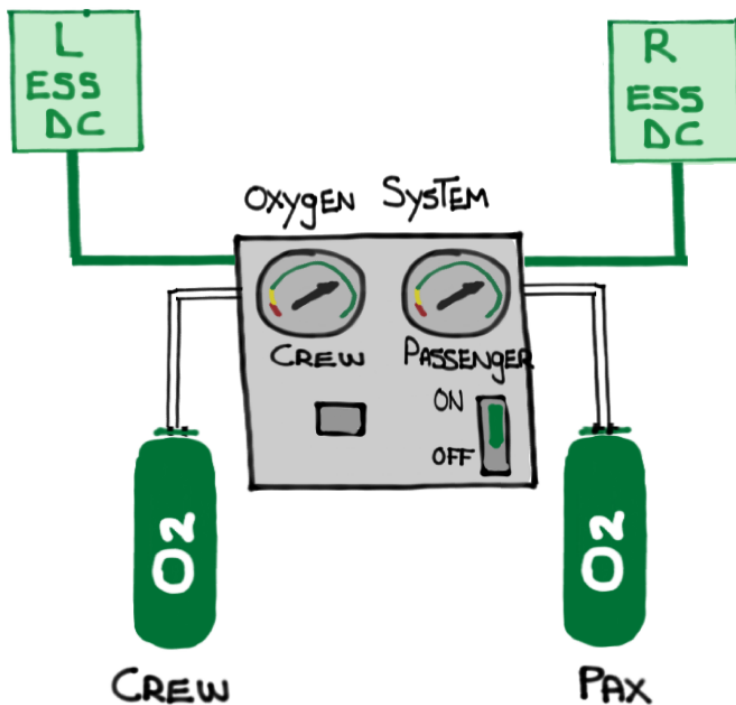

# Oxygen System Test

## - Oxygen Masks:

① Oxygen supply PRESSURE

② Oxygen shutoff control ON

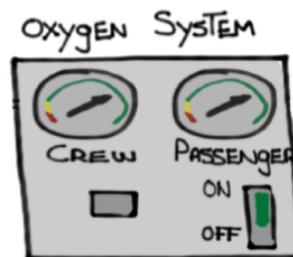

③ PRESS AND hold

- > 1 OR 2 SECONDS  
blinker goes from



(NO LEAK)

- Hissing stops

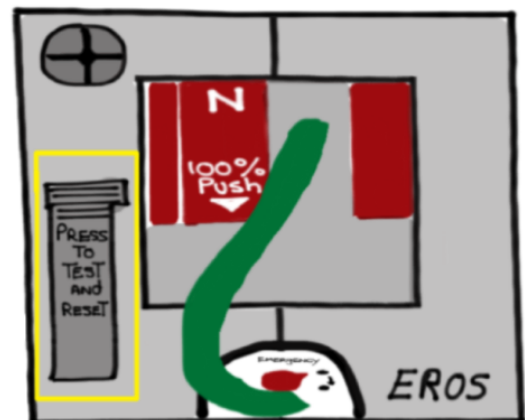

④ While holding "PRESS-TO-TEST" push 

- HISSING RESUMES
- RELEASE BOTH AND hissing stops

- SYSTEM TEST PANEL:

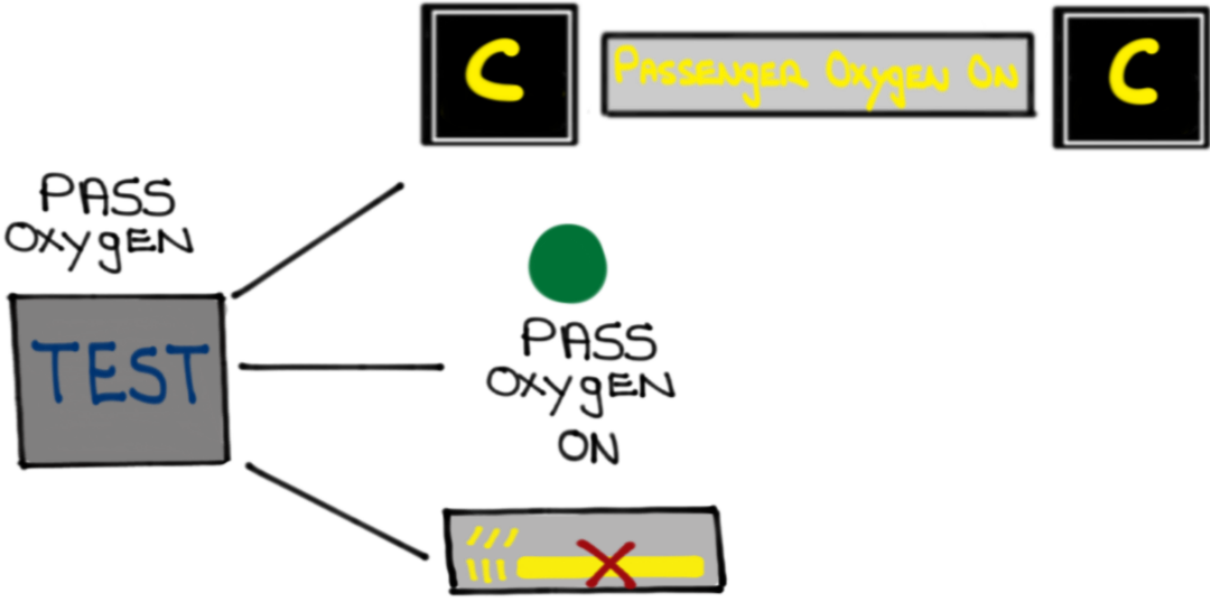



# CREW Oxygen MASKS

## - EROS

- THREE (3) CREW OXYGEN MASK/REGULATOR ASSEMBLIES
- PILOT AND COPILOT: NON-ATTACHABLE GOGGLES
- OBSERVER (JUMP SEAT): NON-ATTACHABLE GOGGLES
- PROVIDE CREW LOW PRESSURE OXYGEN
- QUICK DONNING ( $\leq 5$  SECONDS/ONE HAND OPERATION)
- ALTHOUGH THE CREW AND PASSENGERS SHARE A COMMON OXYGEN SYSTEM THE DELIVERY METHODS ARE DIFFERENT

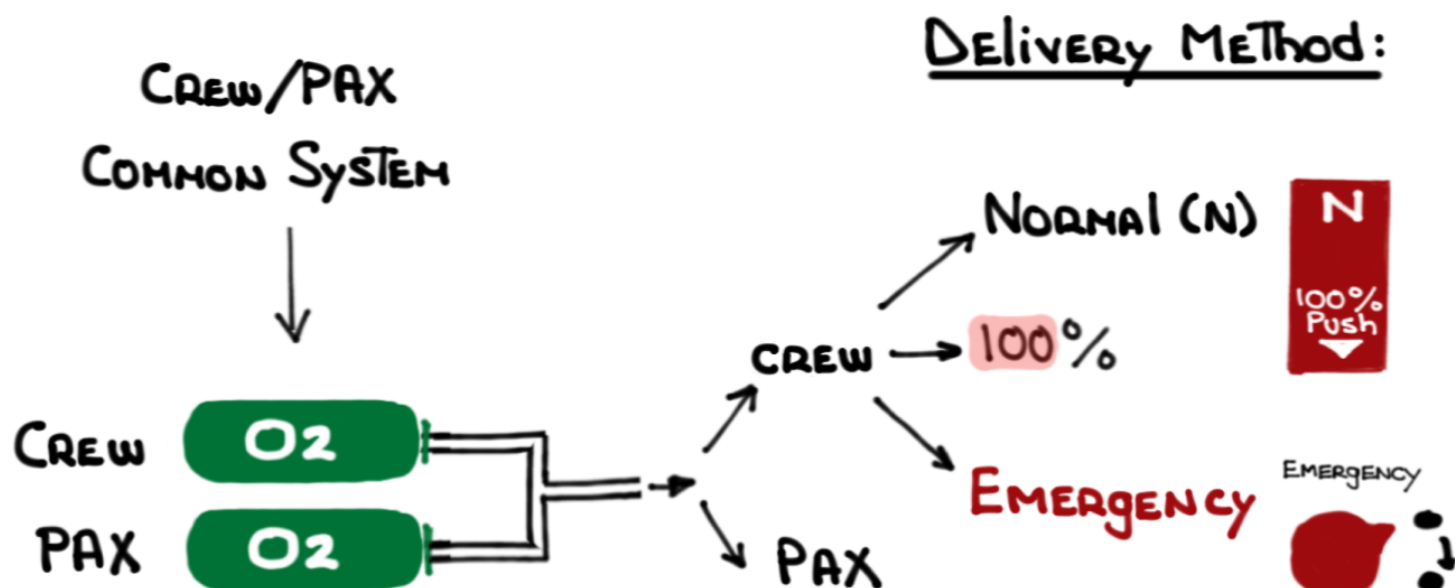



NORMAL (N): diluted mixture of O<sub>2</sub> AND cabin air

100% : ON DEMAND flow of 100% O<sub>2</sub>

EMERGENCY



EMERGENCY: PRESSURIZED flow of 100% O<sub>2</sub>

- MASKS ARE CERTIFIED TO A CABIN ALTITUDE of 40,000' AND AUTOMATICALLY SWITCH TO POSITIVE PRESSURE AT 35,000'

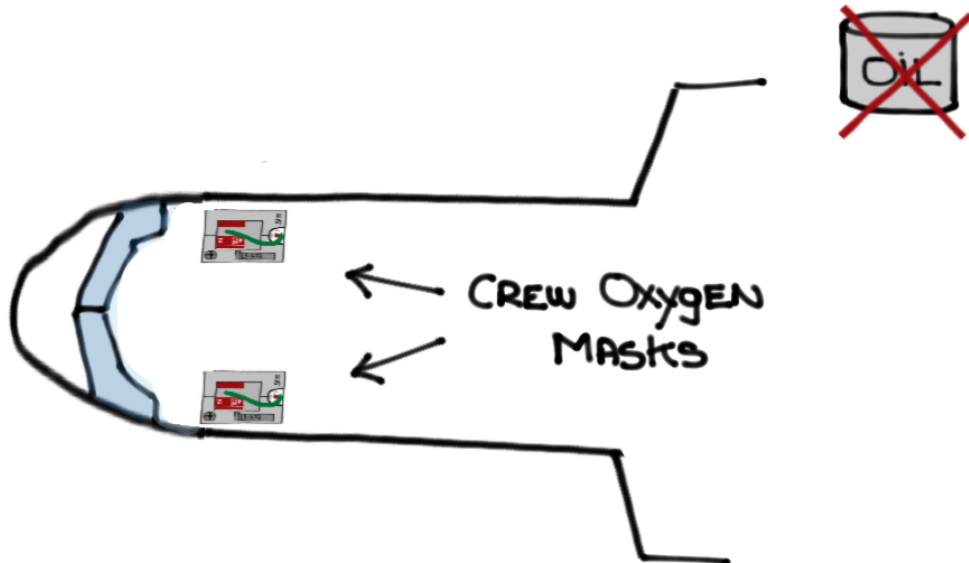
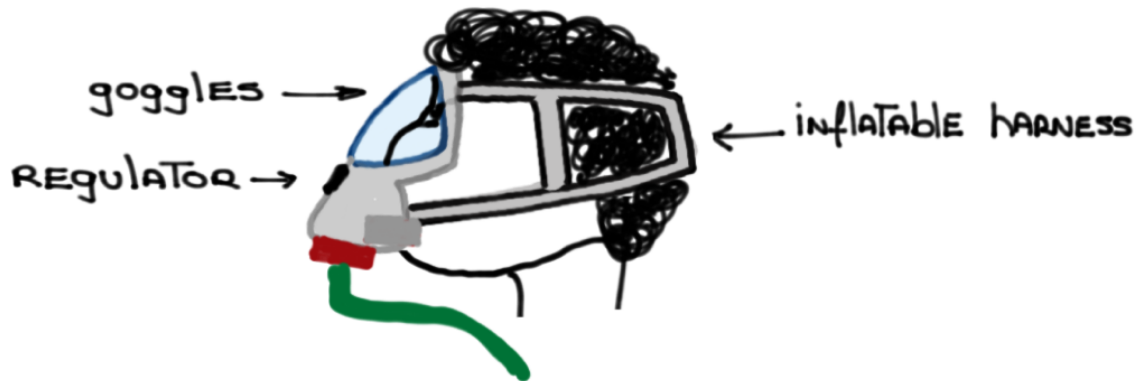

# PASSENGER OXYGEN MASKS

PROVIDE CABIN OCCUPANTS OXYGEN UNTIL THE AIRPLANE IS ABLE TO DESCEND TO AN ALTITUDE WHERE AMBIENT AIR IS DENSE ENOUGH THAT SUPPLEMENTAL OXYGEN IS NO LONGER REQUIRED

- PAX MASKS ARE CERTIFIED TO A CABIN ALTITUDE OF 40,000'
- EMERGENCY DESCENT ONLY. DO NOT PROVIDE SUFFICIENT OXYGEN ABOVE 34,000'
- PAX OXYGEN MASKS CAN BE DEPLOYED EITHER MANUALLY OR AUTOMATICALLY

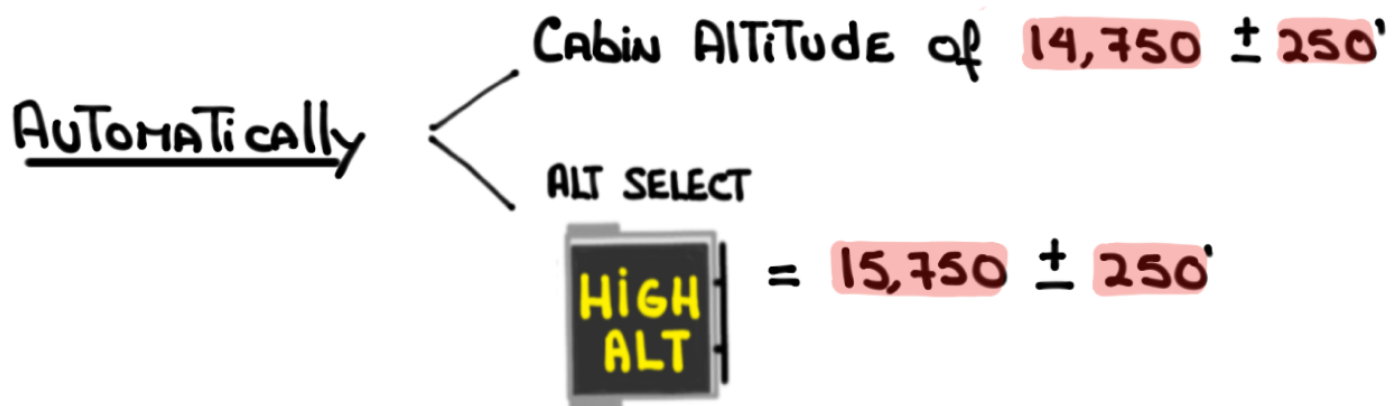

- THE NUMBER OF PAX MASKS INSTALLED VARIES BUT WILL NORMALLY EXCEED THE NUMBER OF PASSENGER SEATS BY AT LEAST 10%

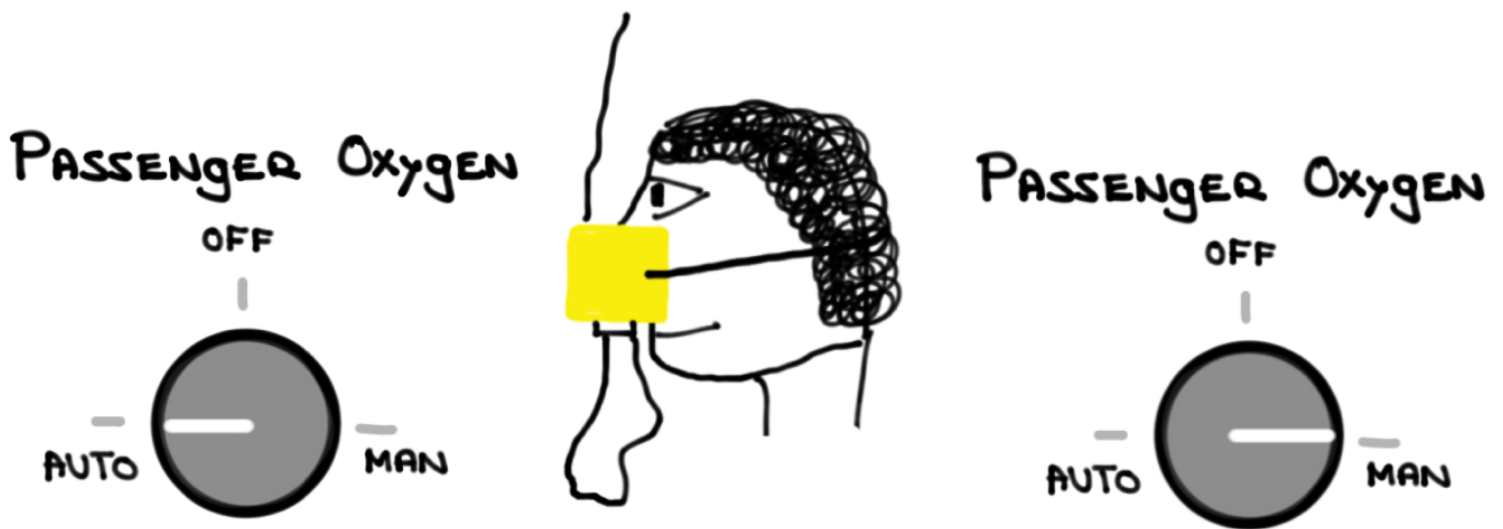
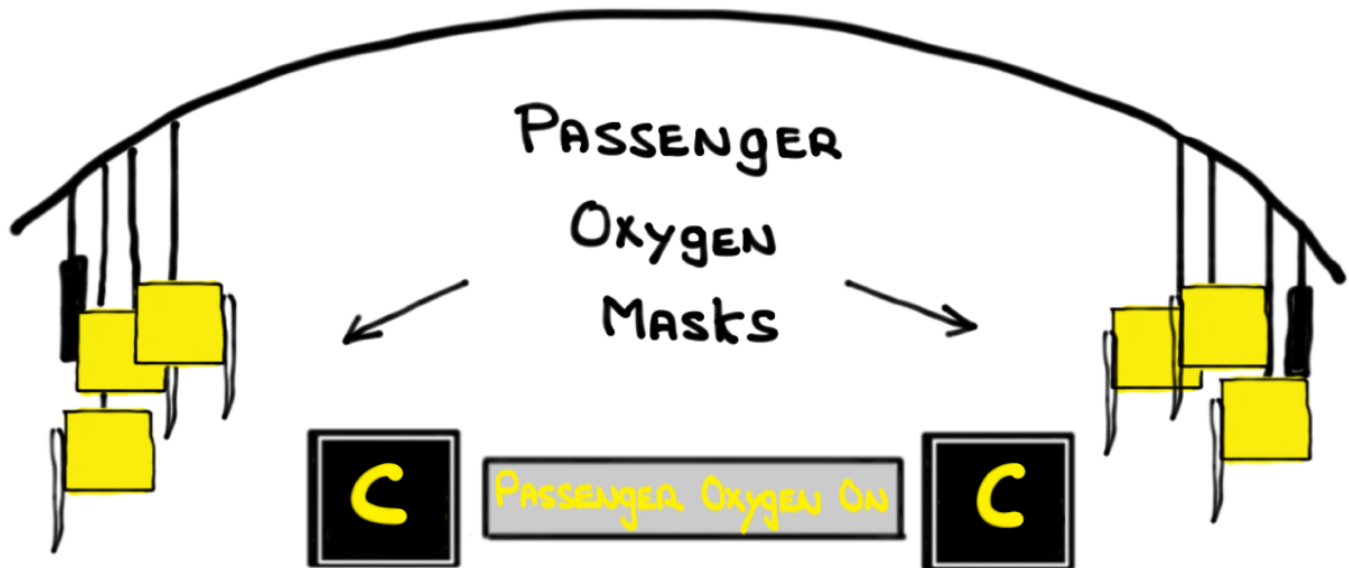

Pull on lanyard To REMOVE pin AND ACTIVATE O<sub>2</sub> flow

# Therapeutic Oxygen

- The Therapeutic Oxygen is available through a receptacle in the cabin
- Administering oxygen should be done in consultation with a medical doctor. Call MedAire or similar medical provider

Therapeutic Oxygen



Starts the flow of oxygen to the receptacle

This is annunciated via a CAS message

Therapeutic Oxygen On



Therapeutic oxygen plug in •

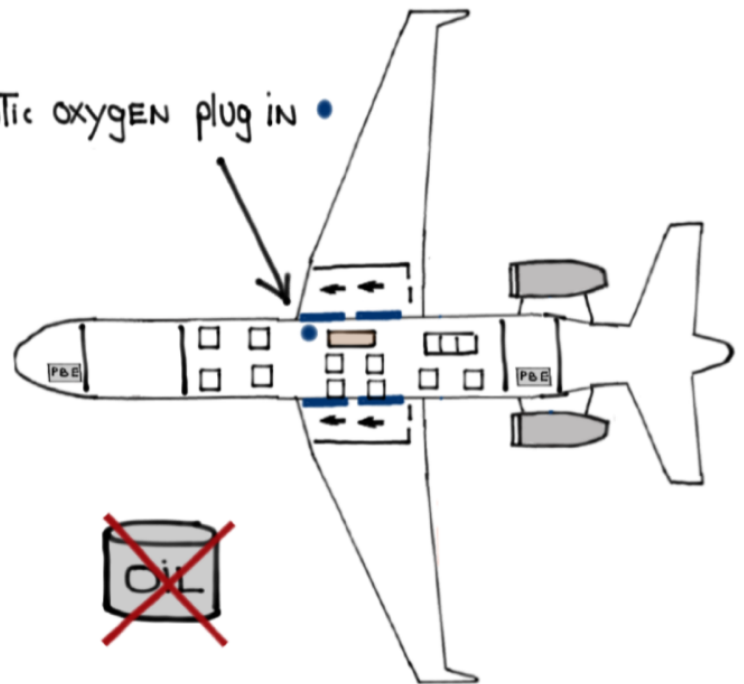

# PROTECTIVE BREATHING EQUIPMENT (PBE)

## - ESSEX PBE

- A PBE is a SELF-CONTAINED PORTABLE/PERSONAL BREATHING DEVICE. IT IS DESIGNED TO SAFEGUARD AGAINST THE HARMFUL EFFECTS OF SMOKE/FUMES by PROVIDING BREATHING OXYGEN while fighting a CABIN FIRE

- ONE (1) PBE IS INSTALLED IN THE AFT LAVATORY

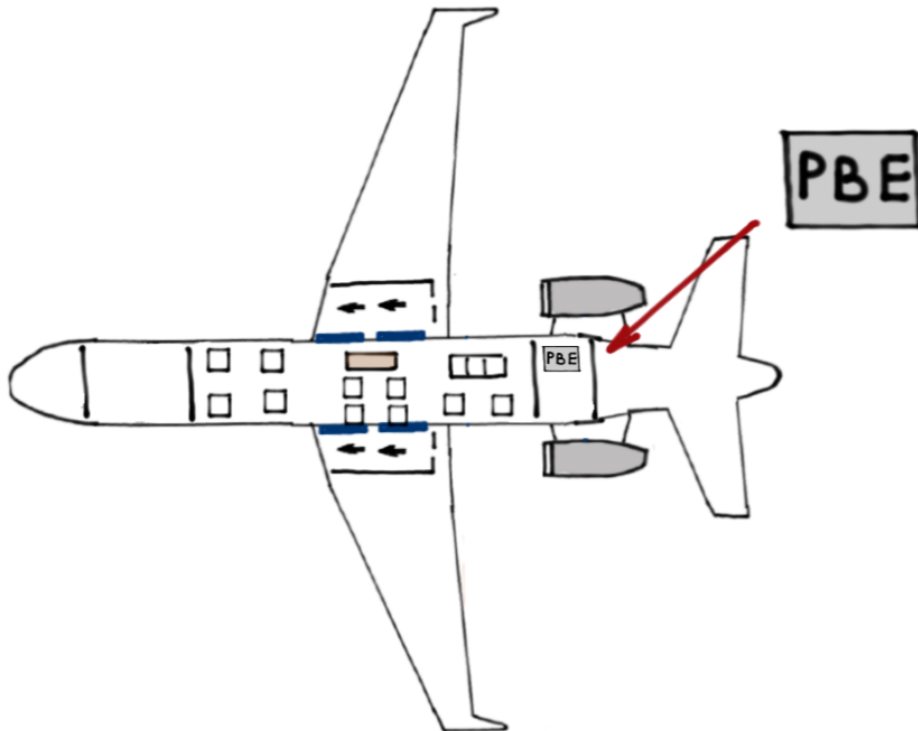

- THE PBE HAS TWO (2) OXYGEN CYLINDERS THAT HOLD A TOTAL OF 36 LITERS OF AVIATOR GRADE OXYGEN

- PBEs provide a 15-MINUTE supply of oxygen
- PBE PRE-flight STATUS INDICATION

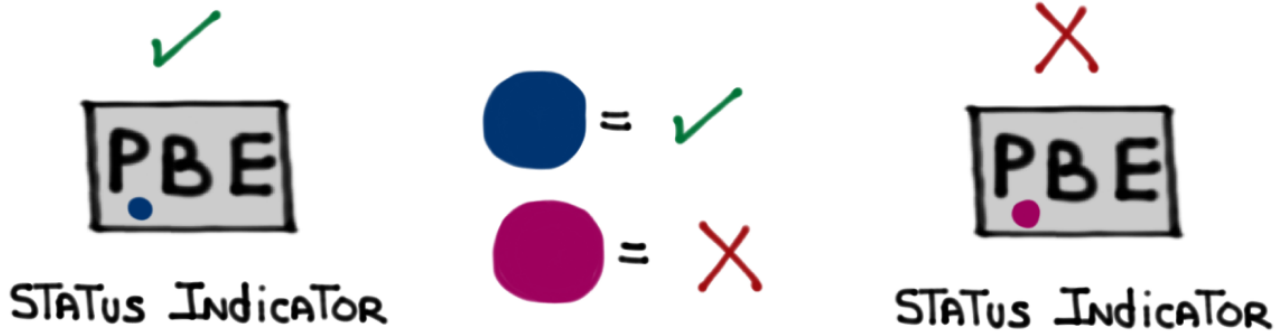

- PBE SERVICE/END of SERVICE light

MOUNTED SLIGHTLY BELOW EYE LEVEL ON THE LEFT INNER SIDE OF THE HOOD. PROVIDES FOR THE MONITORING OF OXYGEN ACTIVATION, FLOW AND END OF OXYGEN SUPPLY

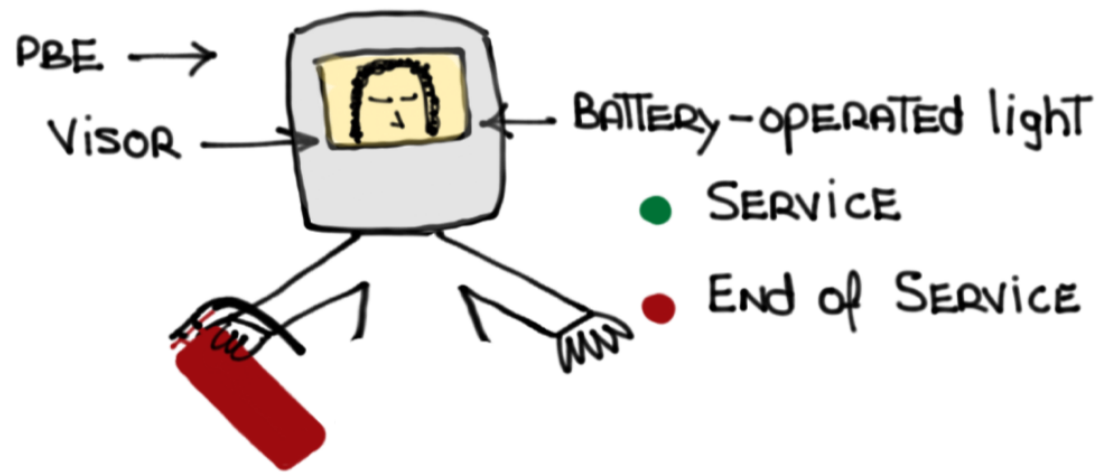

# Oxygen Requirements/Operations

Above 41,000' ONE pilot MUST BE ON oxygen - FAR 91

CREW AND PASSENGER MASKS NOT APPROVED FOR USE ABOVE 40,000' CABIN ALTITUDE

Above 35,000' ONE pilot MUST BE ON oxygen if THE OTHER pilot LEAVES THE COCKPIT - FAR 91

PASSENGER MASKS will NOT provide sufficient oxygen ABOVE 34,000' CABIN ALTITUDE

Above FL 250 CREW MASKS MUST BE IN THE quick donning position which allows donning within FIVE (5) SECONDS

AUTOMATIC DEPLOYMENT OF PASSENGER oxygen MASKS AT 14,750' ± 250' (15,750' ± 250' with )

REFER TO AFM 01-35-10 TO DETERMINE REQUIRED oxygen QUANTITY FOR DEPARTURE



**REMINDER:** these system notes are intended for study purposes only. Always refer to official Gulfstream manuals and other approved references when operating your aircraft.

NOTE: these system notes are updated from time to time and what is posted on Code450.com will always be the most recent version.

Questions, comments or errors...please do send me an email:  
[ivan@code7700.com](mailto:ivan@code7700.com)



Thank you!