

G 550 POWERPLANT

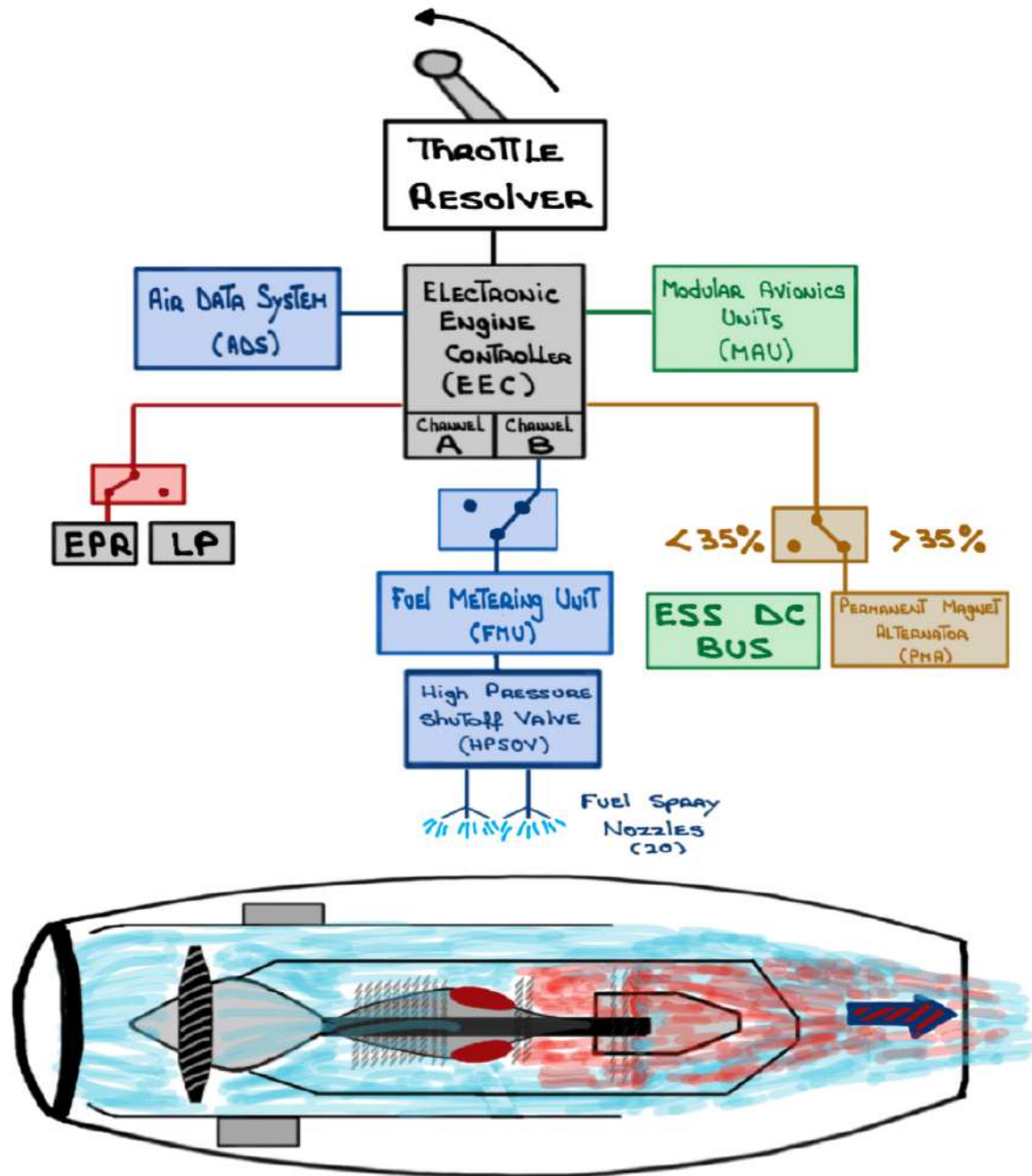

For study purposes only

Two (2) Rolls-Royce BR700-710C4-11

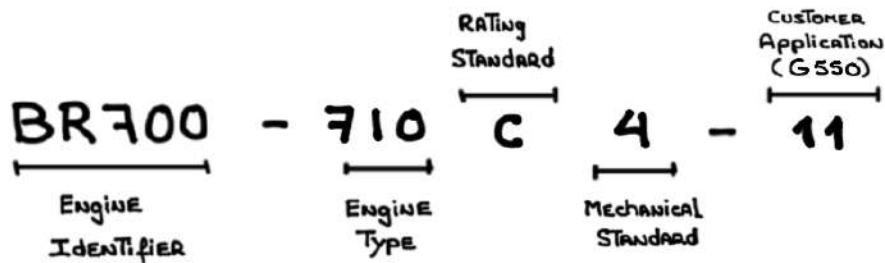

- 15,385 lbs of THRUST @ SEA LEVEL & ISA + 15°C
- High bypass TURBOFAN - 4:1

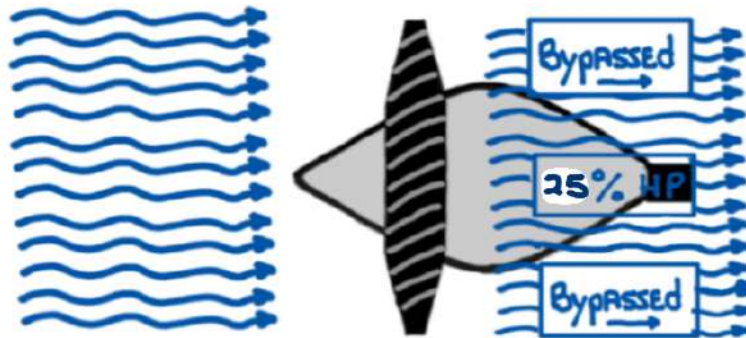

- FADEC - CONTROLLED
- ENGINE PRESSURE RATIO (EPR) $EPR = \frac{\text{OUTPUT}}{\text{INPUT}}$
- TITANIUM INLET COWLING
- High THRUST-TO-WEIGHT RATIO $\left\{ \begin{array}{l} \text{FUEL EFFICIENCY} \\ \text{NOISE REDUCTION} \end{array} \right.$
- RIGHT ENGINE is DESIGNATED AS THE CRITICAL ENGINE
(AFM - PERFORMANCE, SECTION 5.01.10)

- HP AND LP COMPRESSOR SECTIONS ARE DRIVEN BY THEIR OWN COAXIAL SHAFTS (SHAFT WITHIN A SHAFT)

- Twin-spool

- LOW PRESSURE ROTOR

SINGLE-STAGE WIDE CORN, TWENTY-FOUR (24) BLADE FAN DRIVEN BY A TWO (2) STAGE TURBINE

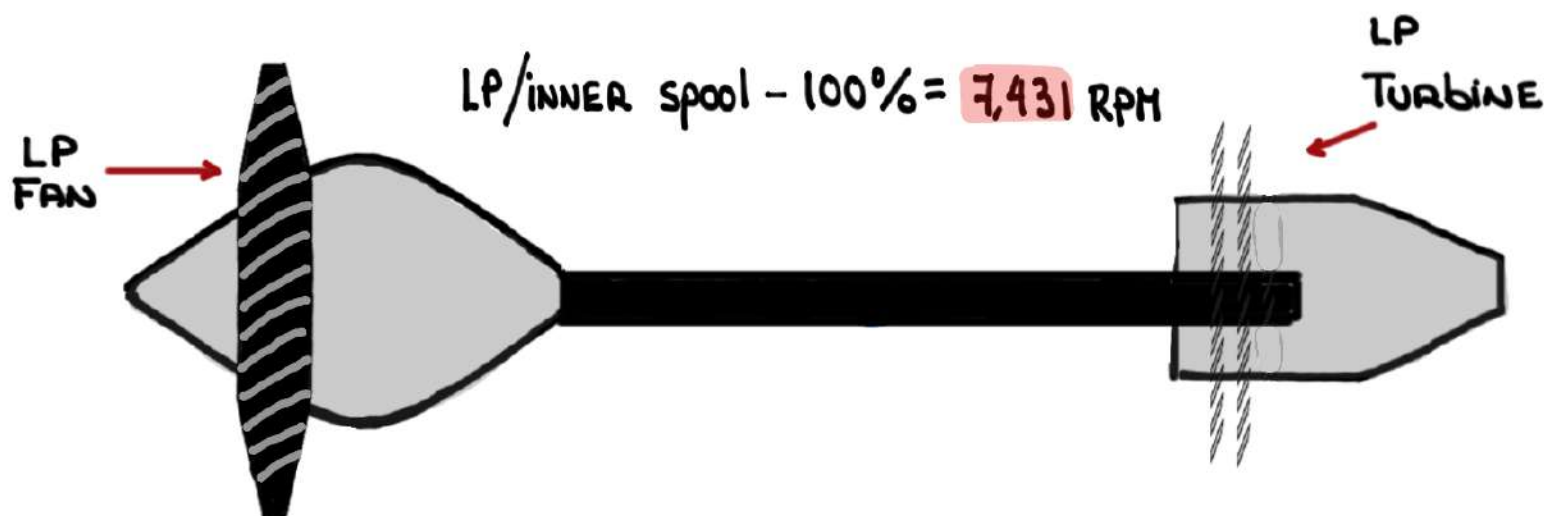

- HIGH PRESSURE ROTOR

TEN (10) STAGE COMPRESSOR DRIVEN BY A TWO (2) STAGE TURBINE

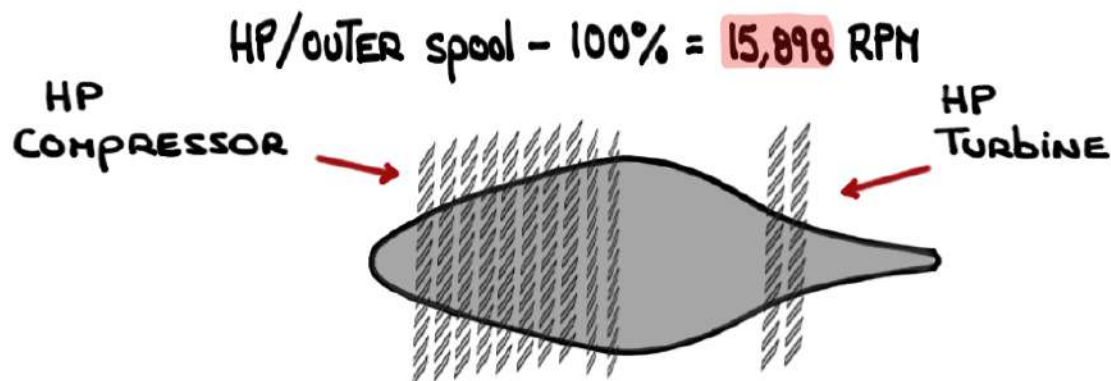

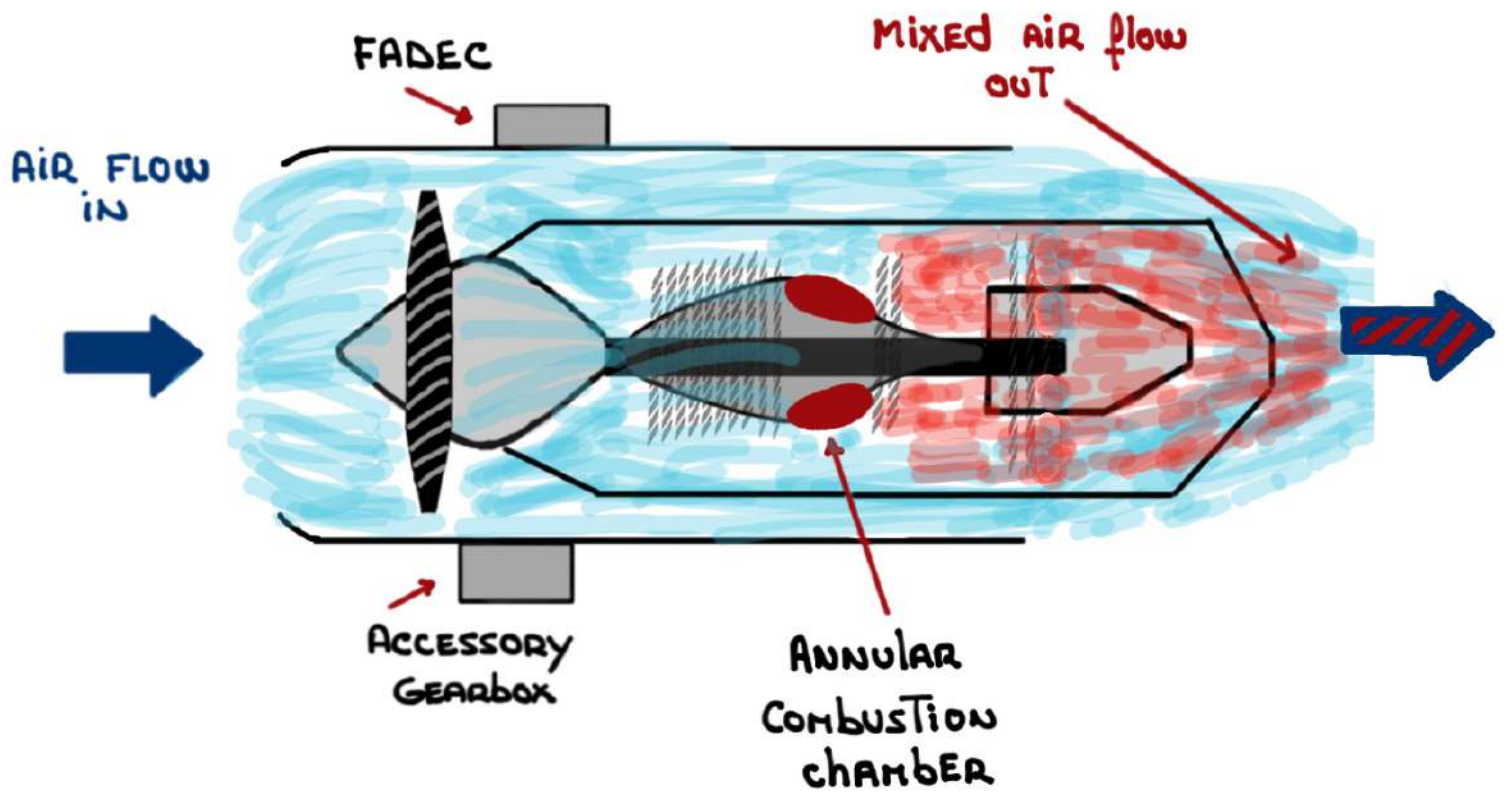
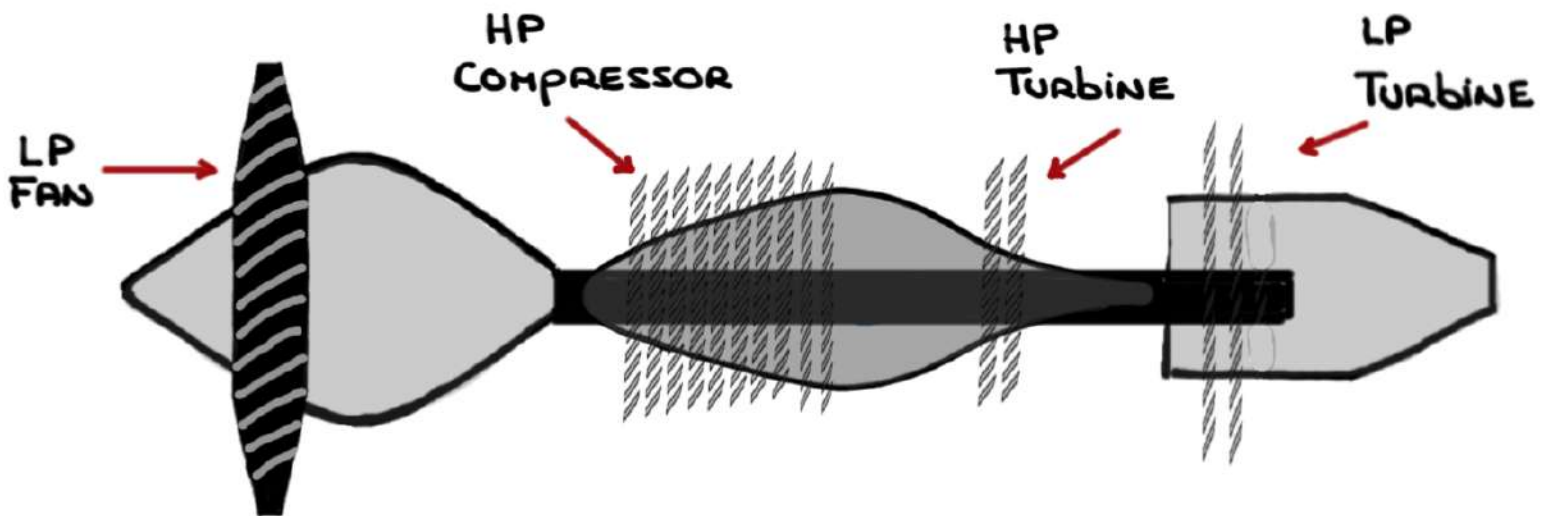

- ACCESSORY GEAR BOX (AGB)

USES POWER EXTRACTED FROM THE HP COMPRESSOR SHAFT
TO DRIVE THE FOLLOWING ACCESSORIES:

- INTEGRATED DRIVE GENERATOR (IDG)
- FUEL METERING UNIT (FMU)
- FUEL PUMP
- OIL PUMP AND BREATHER
- PERMANENT MAGNET ALTERNATOR (PMA)
- HYDRAULIC PUMP

- THE FANS TURN COUNTER-CLOCKWISE WHEN SEEN FROM
THE FRONT

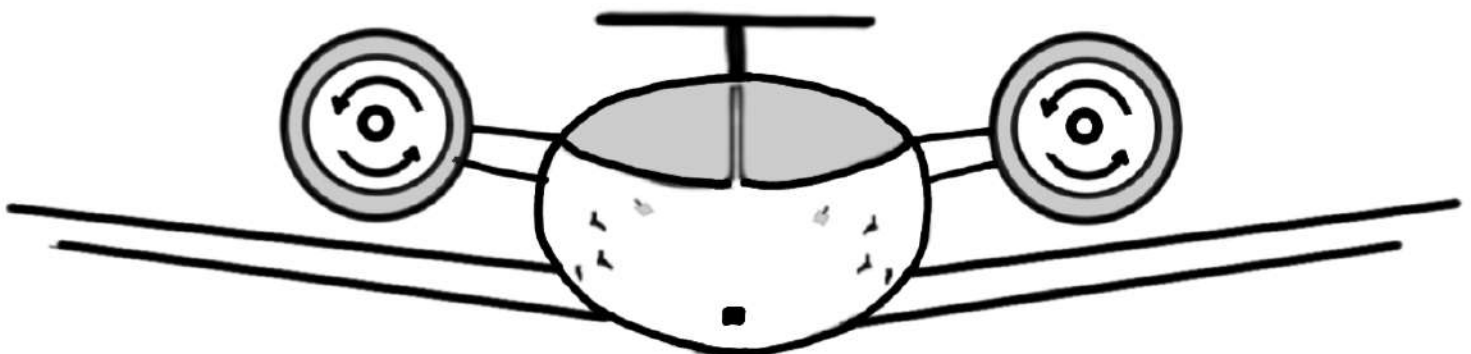

- Full Authority Digital Electronic Control (FADEC):

MOUNTED ON OUTSIDE, UPPER PORTION OF THE ENGINE.

CONSISTS OF THREE (3) MAJOR COMPONENTS:

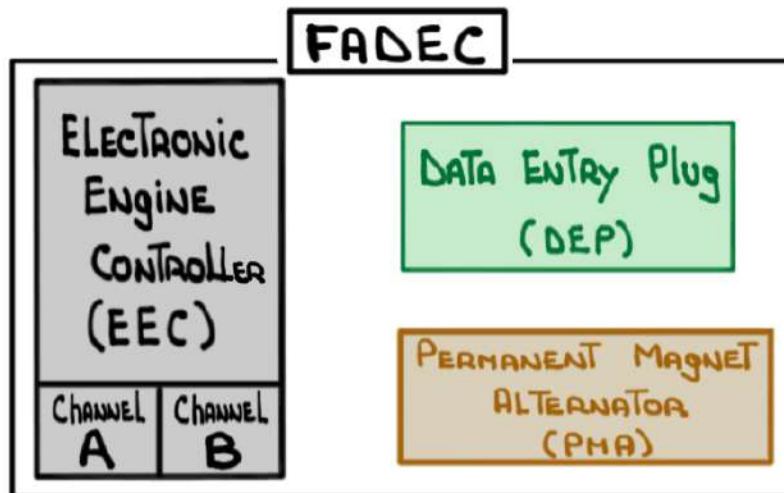

- FADEC PROVIDES ENGINE START PROTECTION :

① ON THE **GROUND** only

② START MASTER
ON switch only

- CONTROLS AND RESPONDS TO EPR REQUIREMENTS

- THE FADEC PROVIDES:

- ENGINE PROTECTION
- IMPROVED HANDLING
- BETTER FUEL EFFICIENCY
- PROLONGED ENGINE LIFE

ELECTRONIC ENGINE CONTROLLER (EEC)

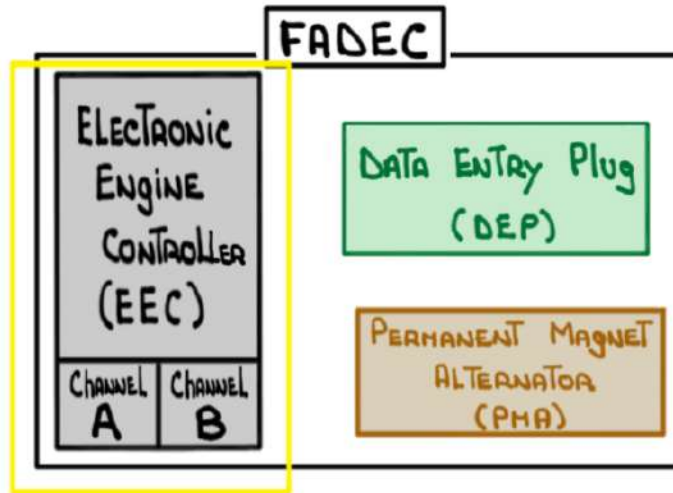

- BRAINS of THE FADEC
- DUAL CHANNELS - ONE ACTIVE AND ONE STANDBY
- FUEL CONTROL SWITCH: CHANGES CHANNELS
- ECC CONTROLS ENGINE IDLE SPEED

Idle Speed Control is based on EPR with Thrust Levers at idle. There are THREE (3) modes:

- ① Low Idle
- ② High Idle
- ③ Ground Idle

① Low Idle:

- Flaps < 22°

② High Idle:

- Flaps > 22°
- WOW - Air
- Wheel speed < 53 knots

③ Ground Idle:

- Aircraft WOW (Ground)
- Touchdown + five (5) seconds
- Delay allows for full and rapid spool up

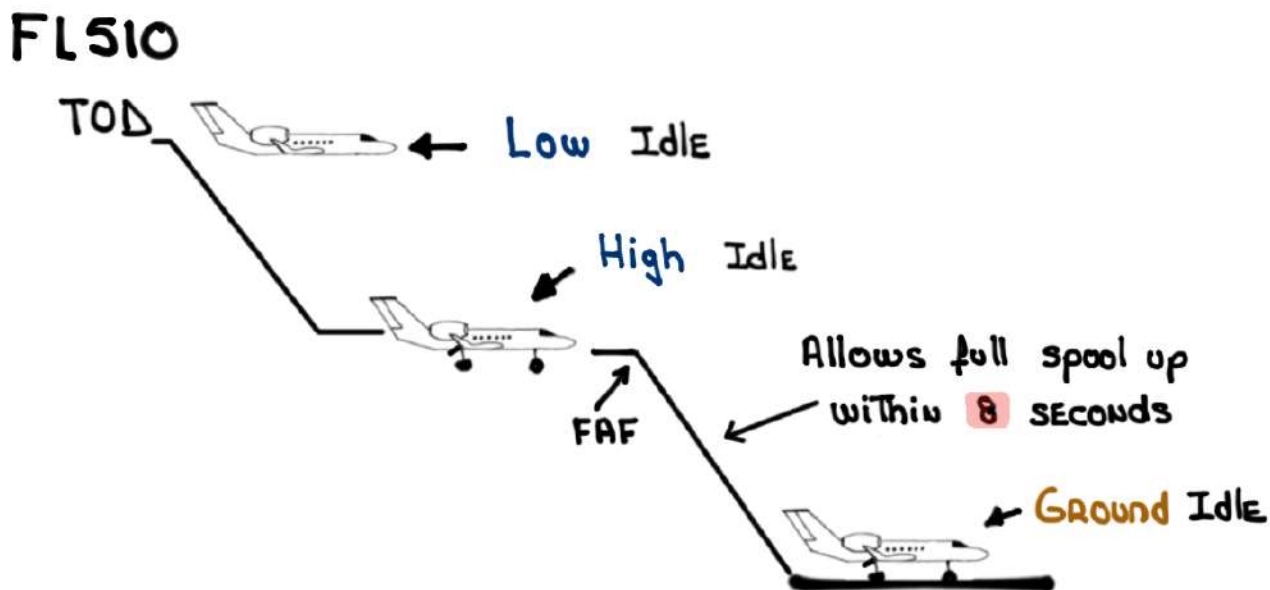

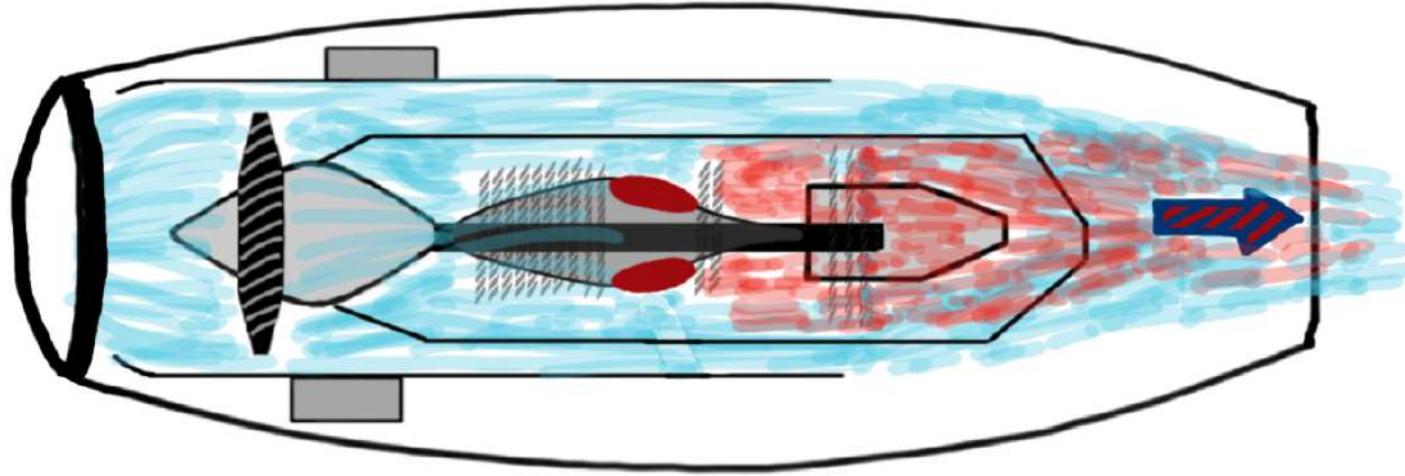
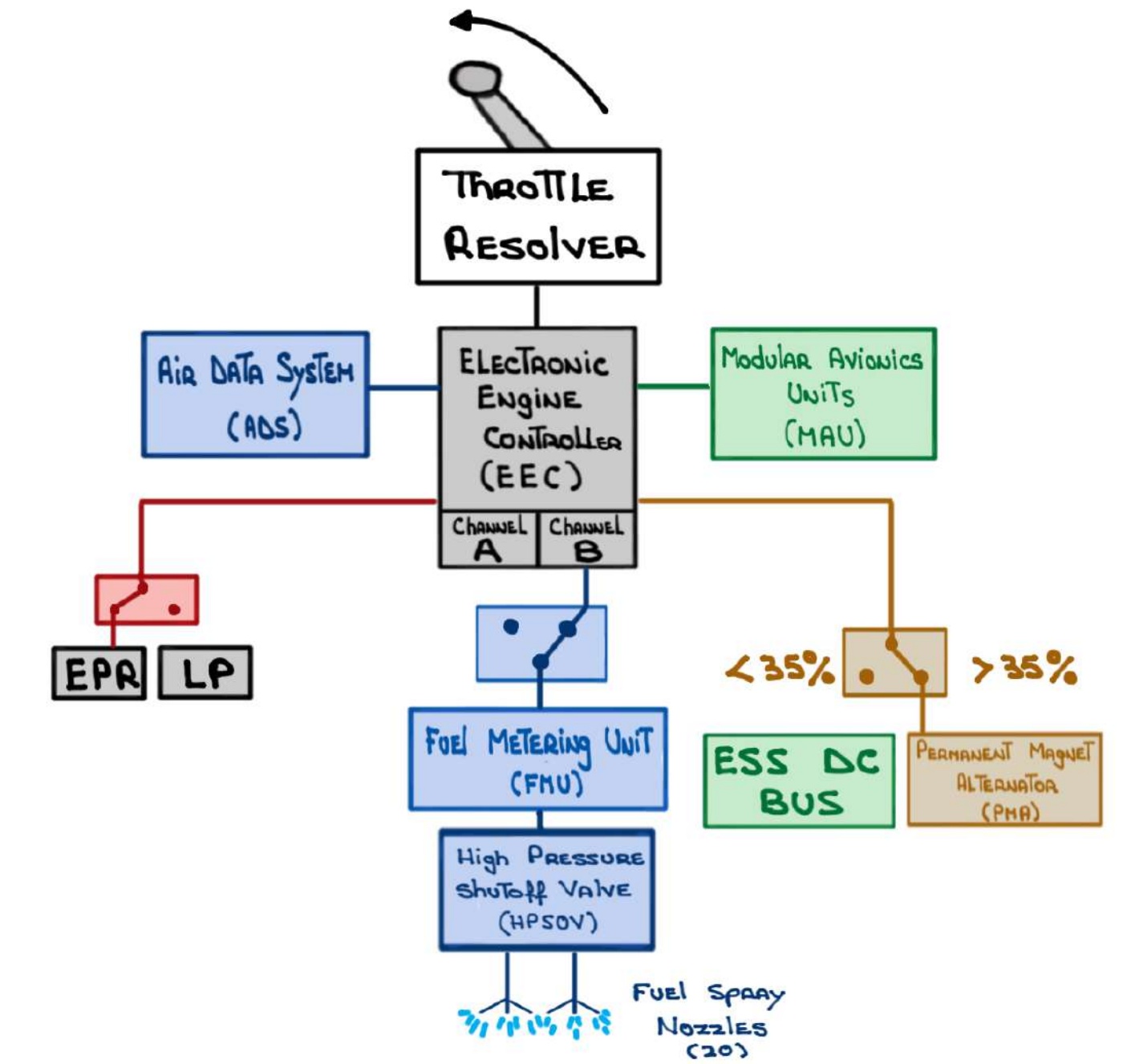

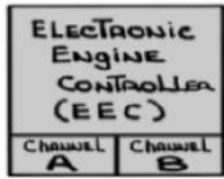

PRIMARY CONTROL MODE
 ALTERNATE CONTROL MODE
 REVERSE THRUST CONTROL MODE

PRIMARY CONTROL MODE EPR
 HP RPM @ idle
ALTERNATE CONTROL MODE LP RPM
REVERSE THRUST CONTROL MODE LP RPM

• INDEPENDENT OVERSPEED PROTECTION (IOP)



YES No
 \ /
 No shutdown

OVERSPEED?



YES YES
 \ /
 * SHUTDOWN

* both

| | |
|------|---|
| EEC | |
| INOP | |
| 1 | 2 |

 CHANNELS MUST AGREE FOR

| | |
|-----|--|
| EEC | |
|-----|--|

 TO COMMAND

| | |
|-----|--|
| FMU | |
|-----|--|

 TO SHUT OFF FUEL TO THE ENGINE

DATA ENTRY PLUG

THE DEP CONTAINS ENGINE TRIM DATA. THIS TRIM DATA IS UTILIZED BY THE EEC TO MAKE ALL ENGINES PRODUCE THE SAME THRUST

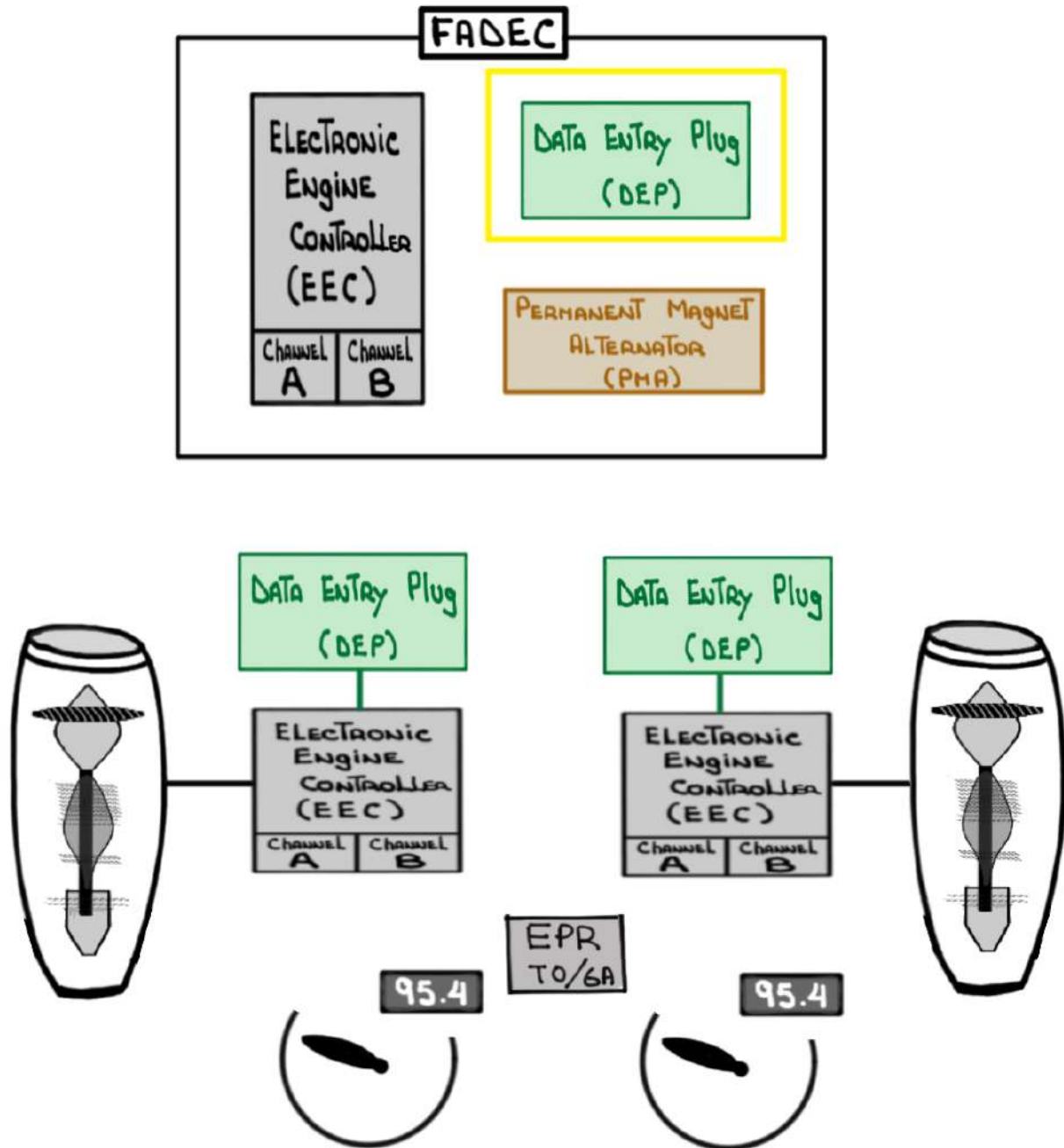

PERMANENT MAGNET ALTERNATOR (PMA)

PRIMARY SOURCE OF EEC POWER ONCE THE ENGINE ACCELERATES > 35% HP RPM

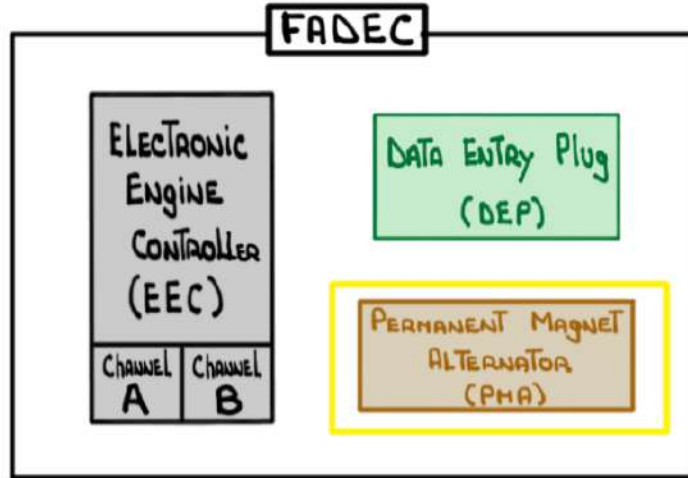

HP RPM

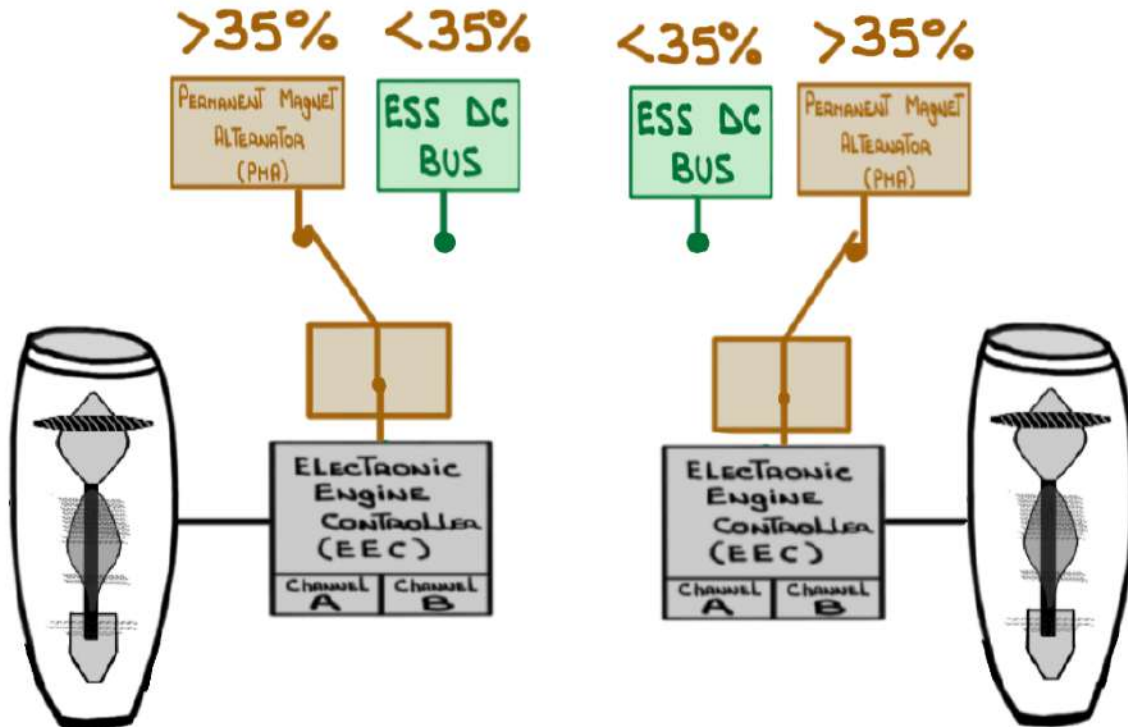

ENGINE Ignition System

- Dual channel Ignition Exciter (A and B) on each engine
- Controlled by dual channel EEC and powered by 28 VDC
- GENERATES high voltage pulse TRANSMITTED THROUGH ignition LEADS TO ignition plugs in COMBUSTOR

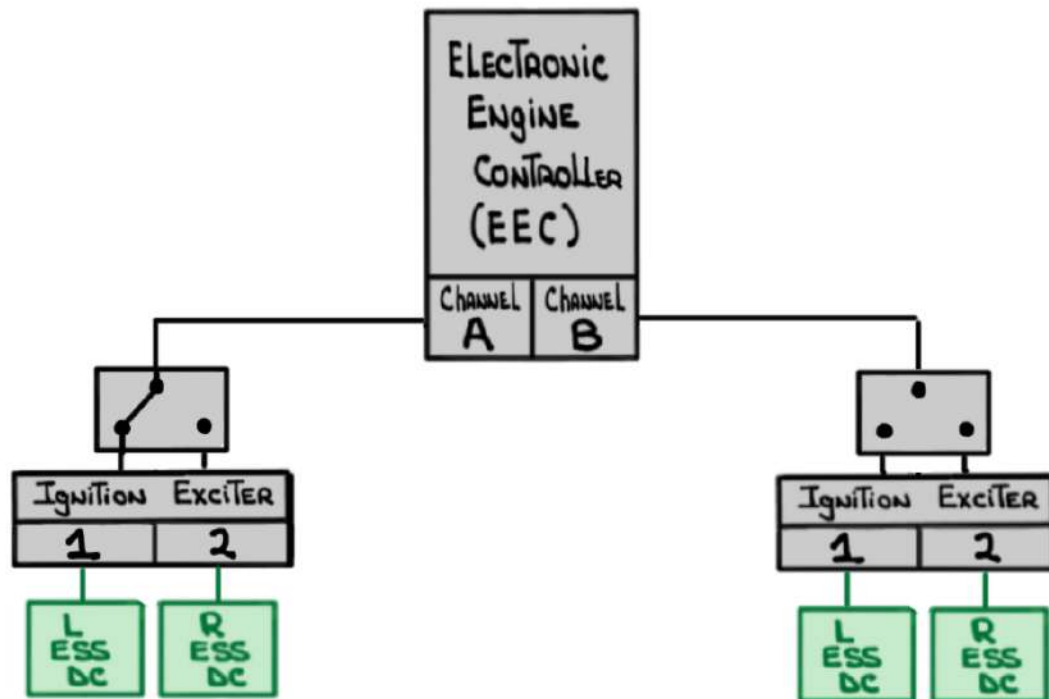

- **GROUND** STARTS → ONE (1) ignITER
- **AIRSTARTS** → Two (2) ignITERS (high SPARKING RATE)

- MANUAL ignition → Two (2) ignitERS
- IgnitERS ARE TURNED OFF AUTOMATICALLY AT 42% RPM HP DURING ENGINE START
- EECs ALTERNATE CHANNELS AND ignitERS AS follows:

1. EEC CHANNEL A / IgnitER 1
2. EEC CHANNEL B / IgnitER 1
3. EEC CHANNEL A / IgnitER 2
4. EEC CHANNEL B / IgnitER 2

Right ENGINE START / IgnitER 1 failed



| | | |
|-------------------------|-------------------------------------|-----------------------|
| 1 ST ATTEMPT | <u>EEC CHANNEL</u> Ignition plug | EEC A X |
| 2 ND ATTEMPT | <u>EEC CHANNEL</u> Ignition plug | EEC B X |
| 3 RD ATTEMPT | <u>EEC CHANNEL</u> Ignition plug | EEC A 2 ✓ |

- THERE IS NO TIME limit ON THE USE of CONTINUOUS ignition

- Ignition modes:

1. AUTO START
2. ALTERNATE START
3. INCREMENT WEATHER MODE
4. AUTO - RELIGHT MODE
5. QUICK RESTART MODE

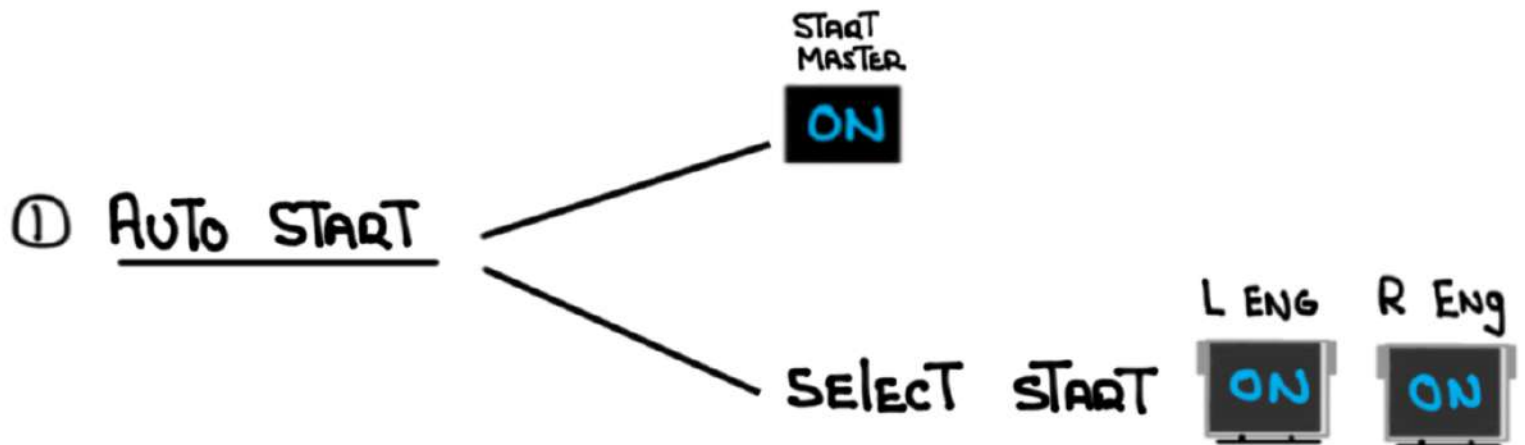

- ONE (1) ignITER only
- EEC ALTERNATES CHANNELS
- FUEL CONTROL SWITCHES CHANGE ignITER plugs

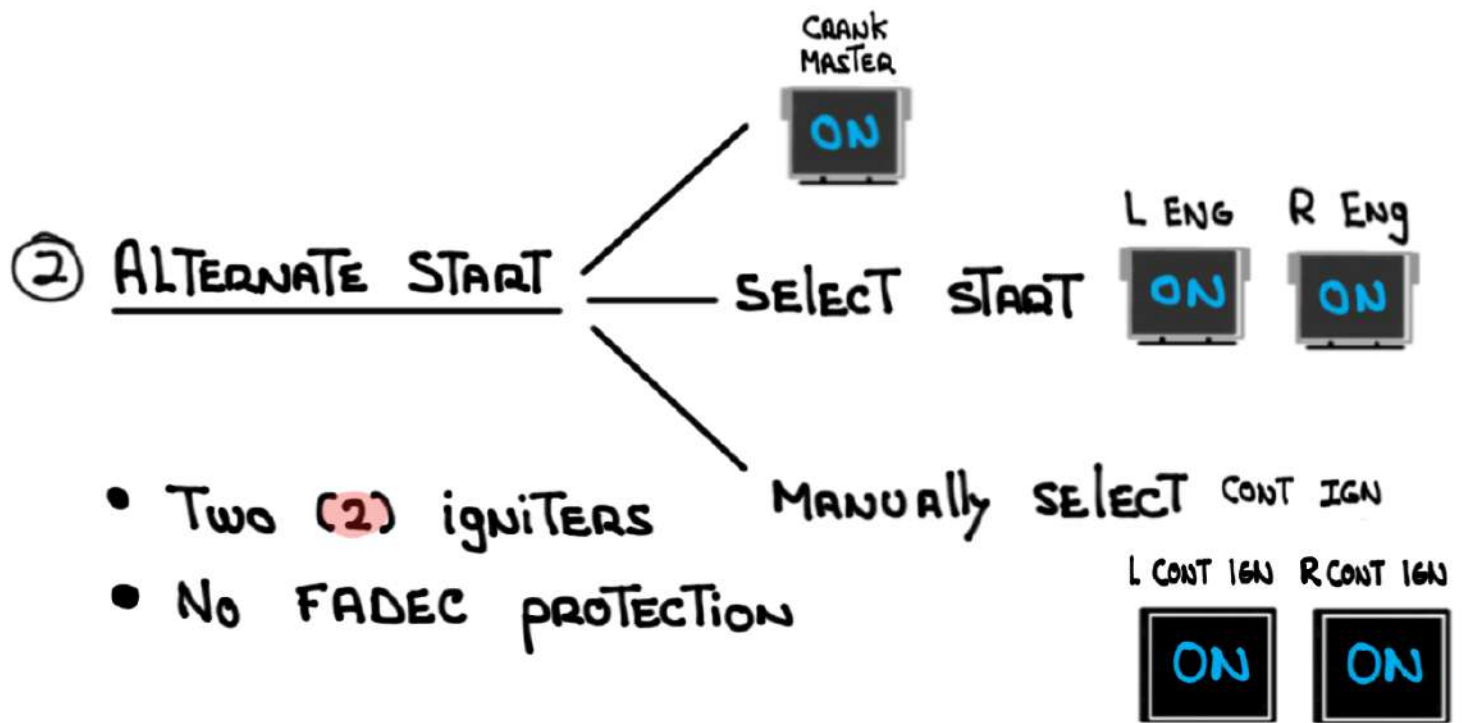

③ INCLEMENT WEATHER MODE

T30 PROBE SENSES MOISTURE

④ AUTO - RELIGHT MODE

HP, LP OR TGT ABNORMALITY

⑤ QUICK - RESTART MODE

- INADVERTENT ENGINE SHUTDOWN INFLIGHT
- RETURN FUEL CONTROL TO RUN WITHIN **30** SECONDS

ENGINE FUEL SYSTEM

- METERED FUEL FROM TANKS' BOOST PUMPS TO NOZZLES
- INTRODUCTION OF FUEL IS CONTROLLED BY THE EEC
- LOW PRESSURE FUEL COMING FROM THE WINGS
- HIGH PRESSURE FUEL COMING FROM THE FUEL METERING UNIT (FMU)

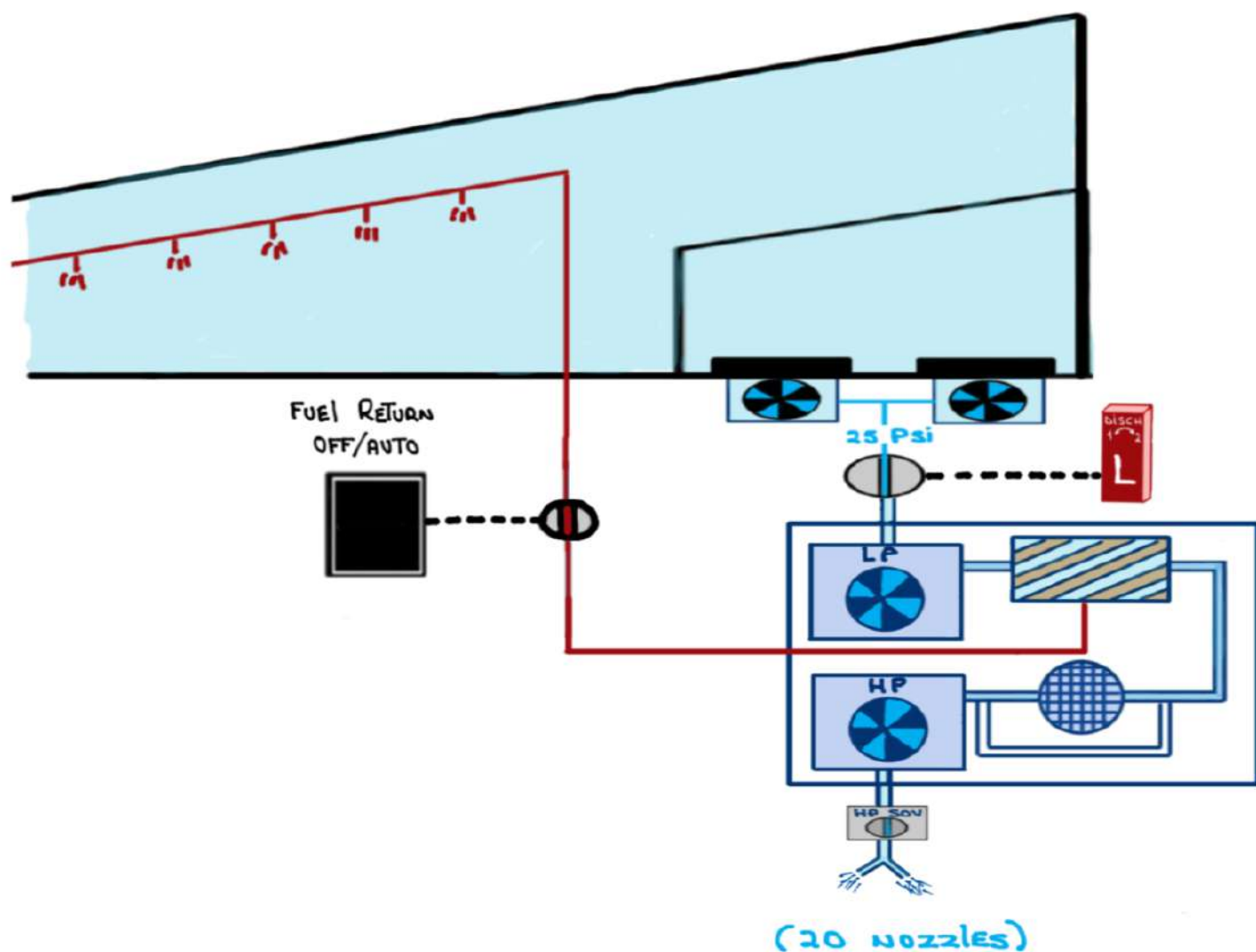

- As Thrust Levers are advanced or retarded the EEC commands the FMU to modulate fuel to nozzles

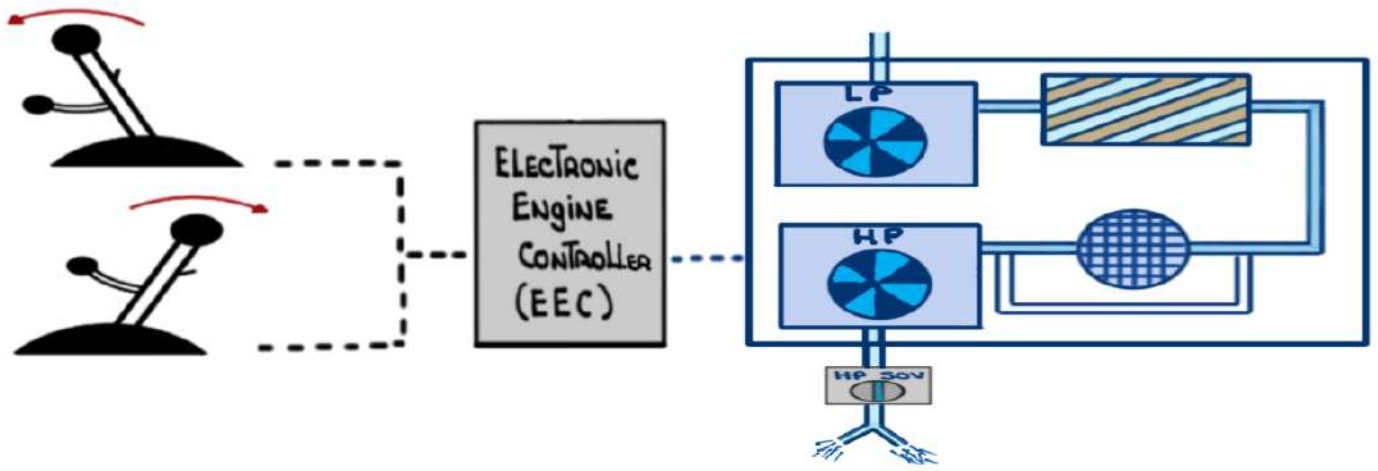

- Placing a fuel control switch to OFF closes FMU
All fuel is cutoff to the fuel nozzles and the engine shuts down

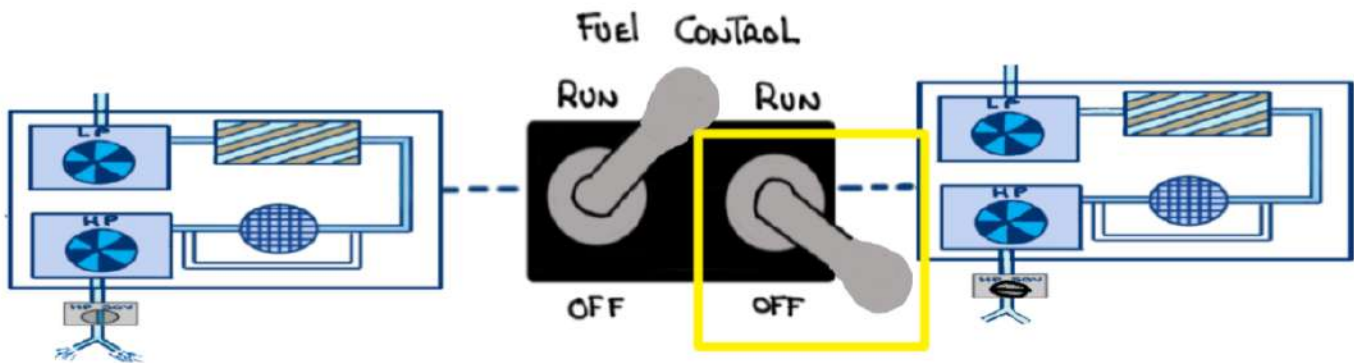

- The FMU contains two (2) internal pumps:

- Low Pressure (LP) 1st stage →
- High Pressure (HP) 2nd stage →

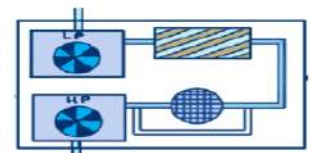

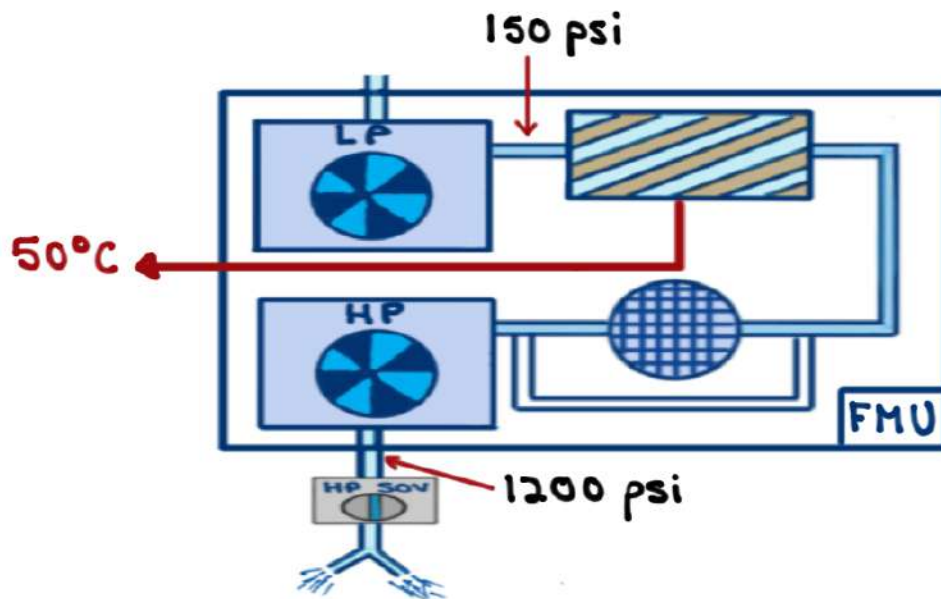

- THE LP AND HP PUMPS ARE DRIVEN BY THE ENGINE ACCESSORY GEARBOX
- A FUEL FILTER RECEIVES FUEL FROM THE 1ST STAGE LP PUMP AND REMOVES DEBRIS AND CONTAMINANTS
- A FILTER BYPASS VALVE ENSURES CONTINUAL FUEL FLOW TO THE ENGINE IF FILTER IS BLOCKED
- EXCESS FUEL IS RECIRCULATED THROUGH THE FUEL/OIL HEAT EXCHANGER 

IMPENDING FUEL FILTER blockage in INDICATED ENGINE

L FUEL FILTER

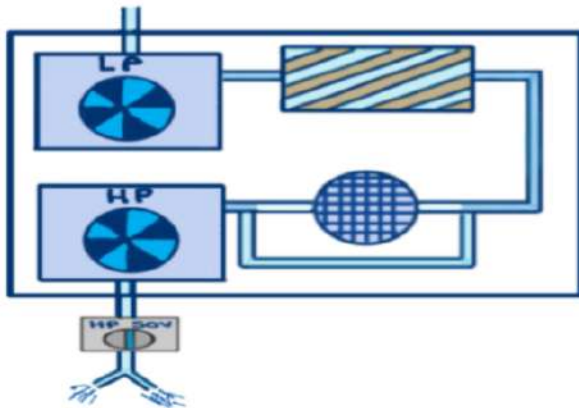

OR

R FUEL FILTER

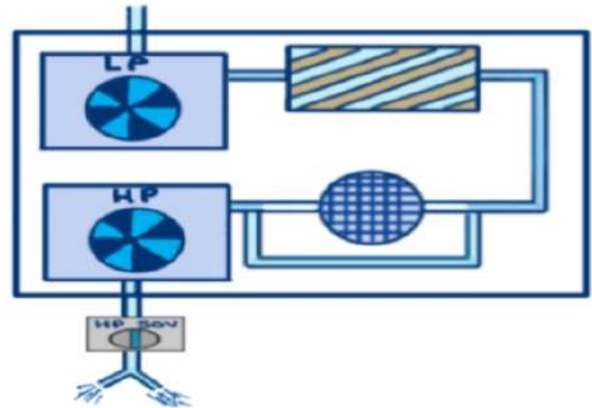

5 psi differential = Cyan CAS MESSAGE

IMPENDING fuel filter blockage in both ENGINES

L-R FUEL FILTER

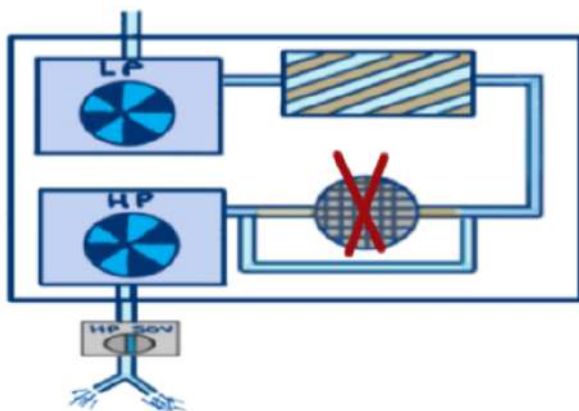

AND

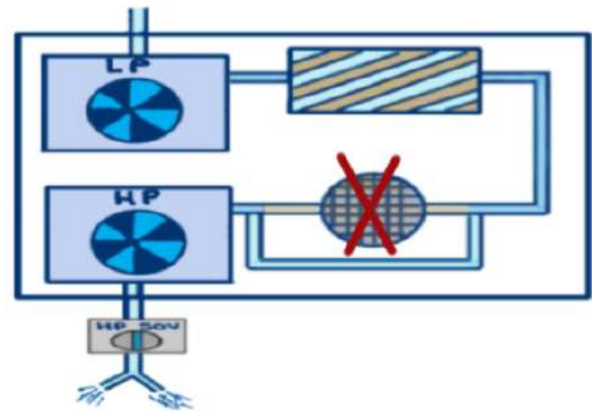

25 psi differential = filter bypasses

- FUEL CONTROL switches shutoff fuel AT THE pylon
- Each ENGINE has its own **FIRE HANDLE**

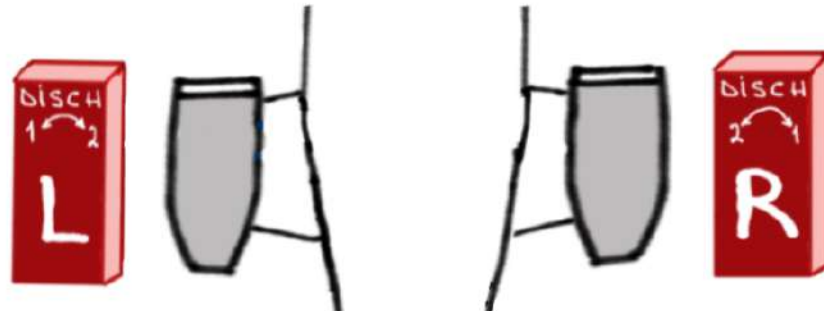

- Pulling a **FIRE HANDLE** shuts off fuel AT THE TANK

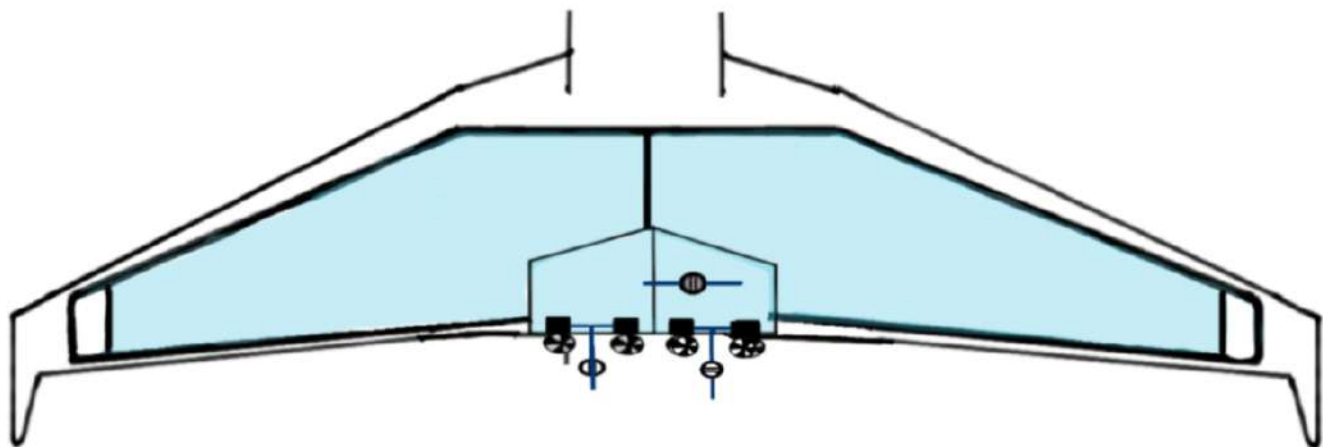

- SOV position indicator - wheel well

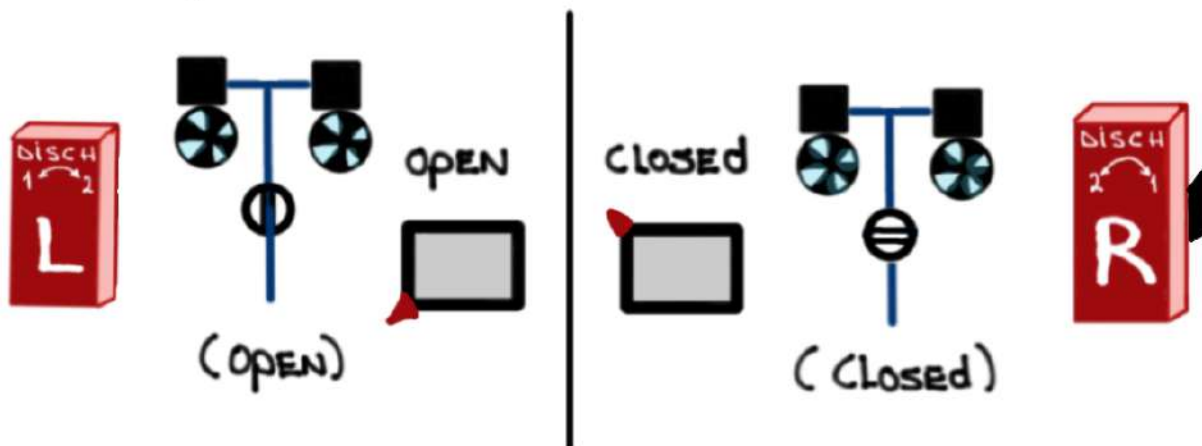

ENGINE OIL SYSTEM

ENGINE OIL TANK: 32.8 U.S. PINTS / 15.5 LITERS

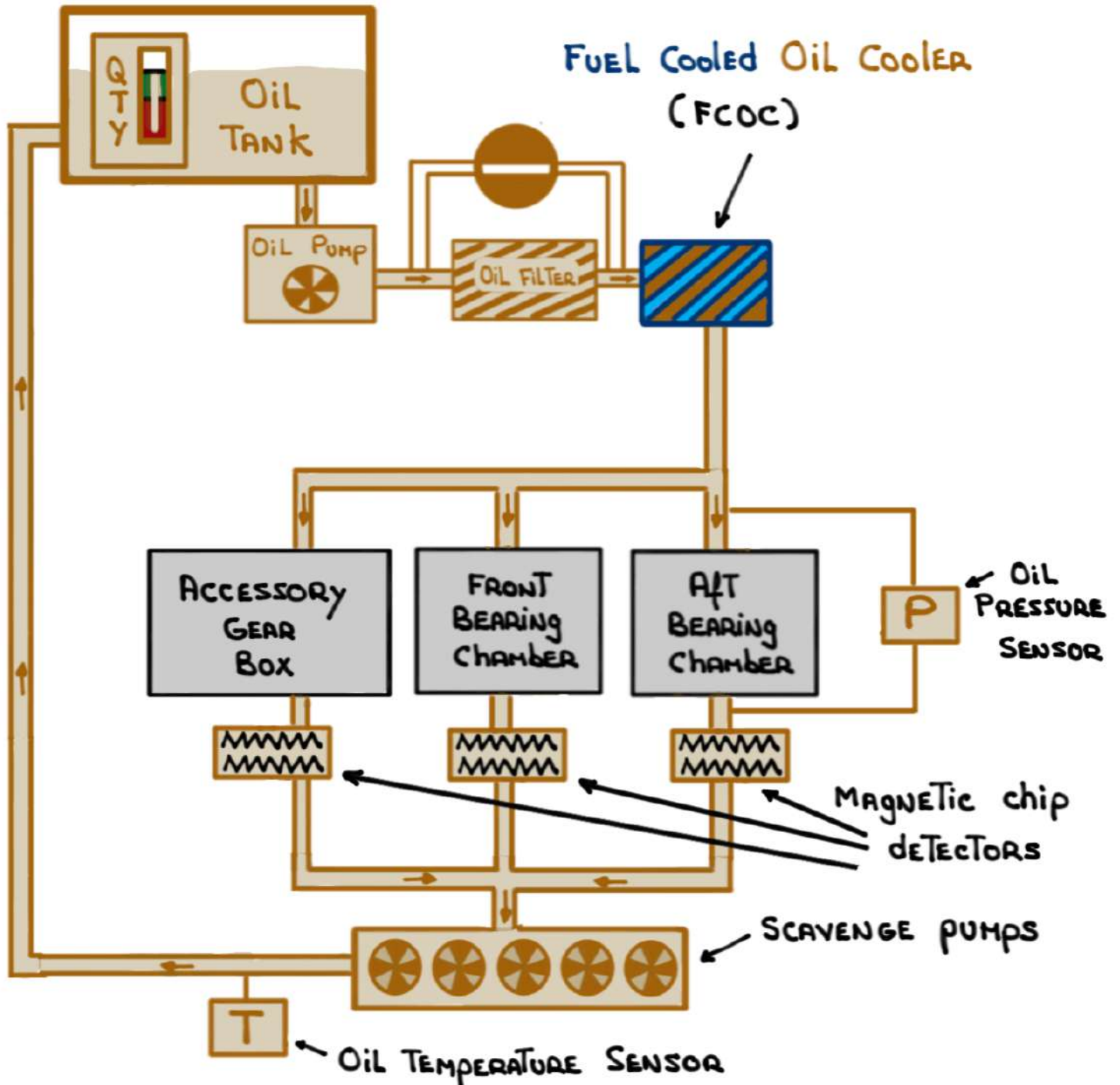

- The oil breather uses centrifugal circulation to remove oil mist from the vent lines and dump it overboard. Oil in the vent lines is collected by the scavenger pumps and returned to the oil tank.

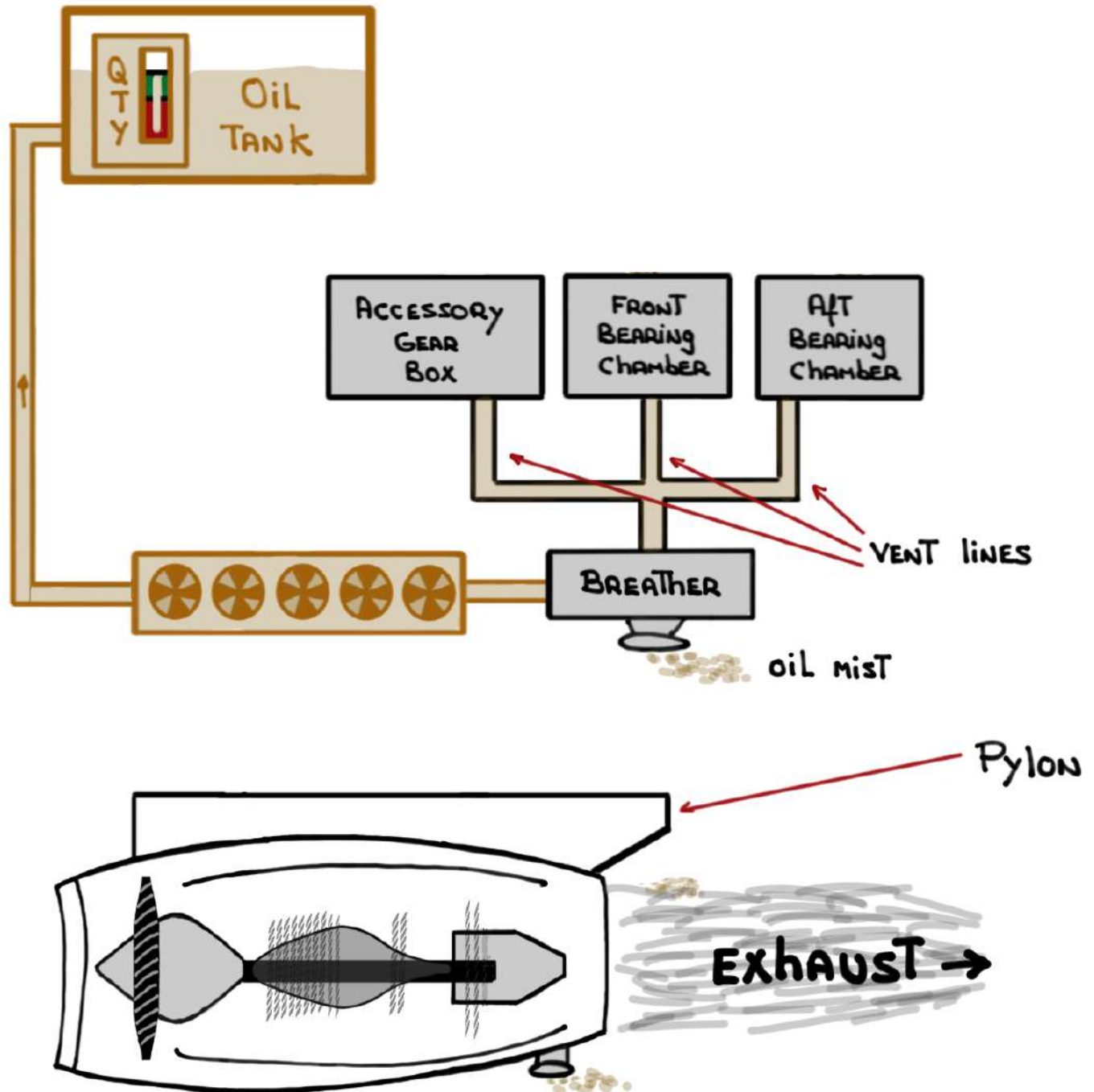

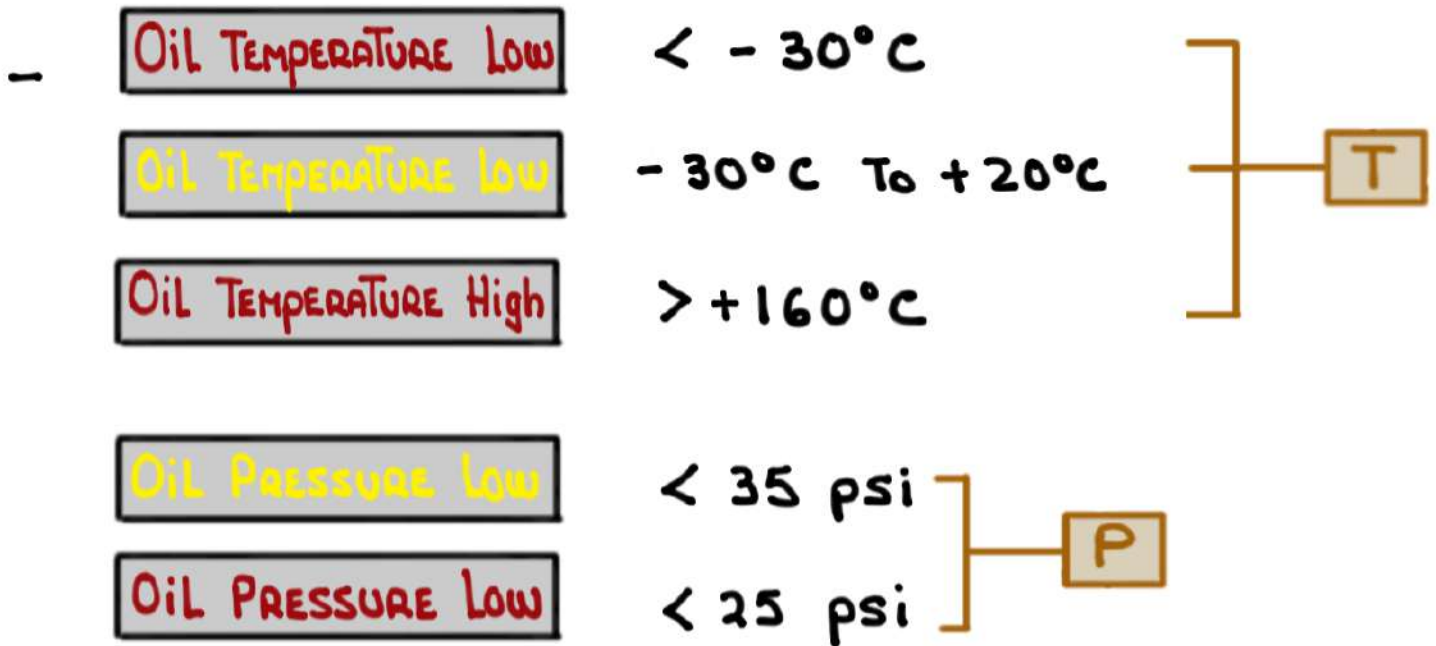

- ENGINE OIL SERVICING
 - CONVENTIONAL GRAVITY
 - REMOTE REPLENISHMENT SYSTEM

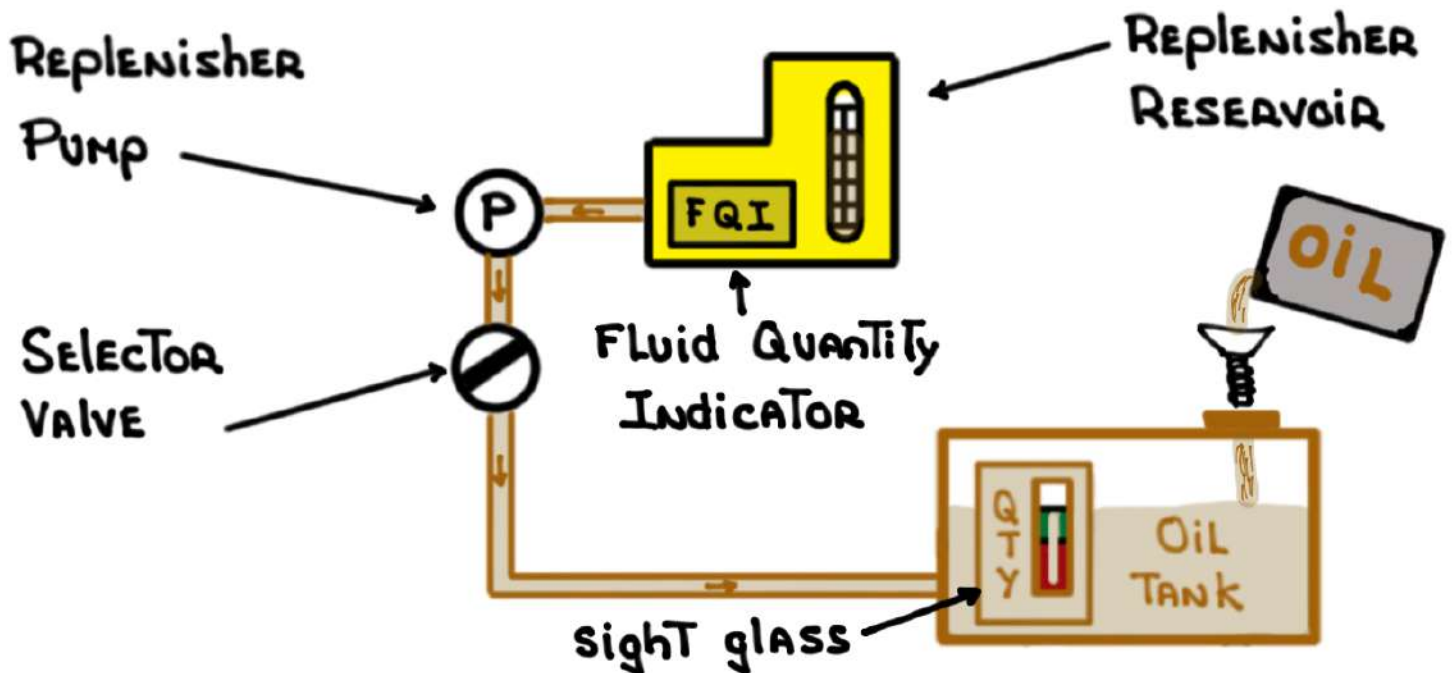

ENGINE LIMITATIONS

ENGINE OIL TEMPERATURE

- 30°C START
- +20°C TAXI/TAKEOFF
- +160°C MAXIMUM

ENGINE FUEL TEMPERATURE

- 40°C
- +140°C (UNRESTRICTED)
- +165°C (15 MINUTES)

ENGINE START CYCLES

| | Cycle | COOLING PERIOD |
|--|-----------|----------------|
| | 3 MINUTES | 15 SECONDS |
| | 3 MINUTES | 15 SECONDS |
| | 3 MINUTES | 15 MINUTES |

ENGINE TGT TEMPERATURE

- 150°C INTRODUCE FUEL
- 700°C START - GROUND
- 850°C START - Inflight
- 900°C TAKEOFF (5 MINUTES)
- 900°C OEI (10 MINUTES)
- 860°C MAX CONTINUOUS

ENGINE OIL LEVEL CHECK

- >5 <30 MINUTES FROM SHUTDOWN
- LAST flight of THE DAY
- 24 CUMULATIVE HOURS

ENGINE LIMITATIONS - START

MINIMUM OIL TEMPERATURE -30°C

MINIMUM BLEED AIR 40 PSI

MAXIMUM TGT < FUEL $+150^{\circ}\text{C}$

MAXIMUM TGT $+700^{\circ}\text{C}$

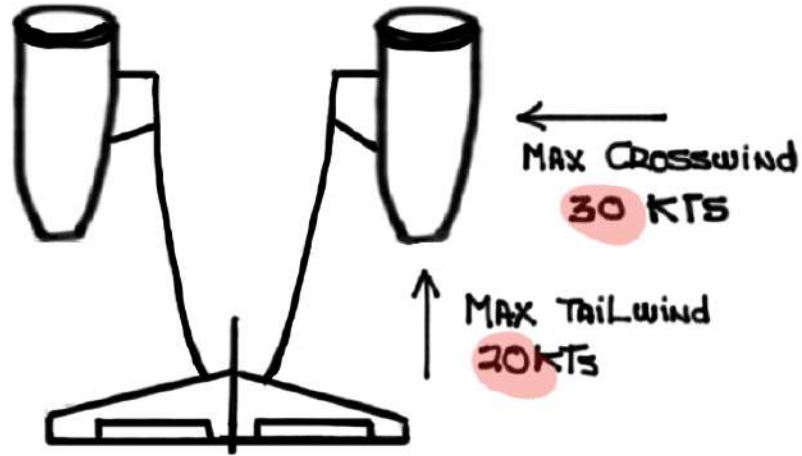

ENGINE START cycles $3\text{ MINUTES} / 15\text{ SECONDS}$
 $3\text{ MINUTES} / 15\text{ SECONDS}$
 $3\text{ MINUTES} / 15\text{ MINUTES}$

ENGINE ROTOR BOW $> 20\text{ MINUTES} < 5\text{ HOURS}$

ENGINE LIMITATIONS - KEEP OUT ZONE

$> 10\text{ SECONDS}$

$> \cancel{66-80\%}\text{ LP} <$

AUTOMATIC PROTECTION:
- PARKING BRAKE SET
- WHEN IN REVERSE THRUST

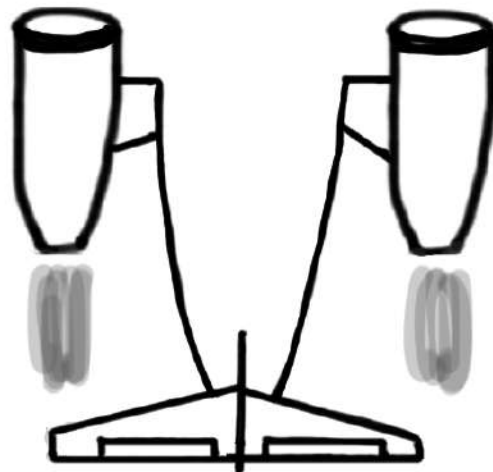

ENGINE LIMITATIONS - TAKEOFF

TAKEOFF in ALT mode (LP) is **Prohibited**

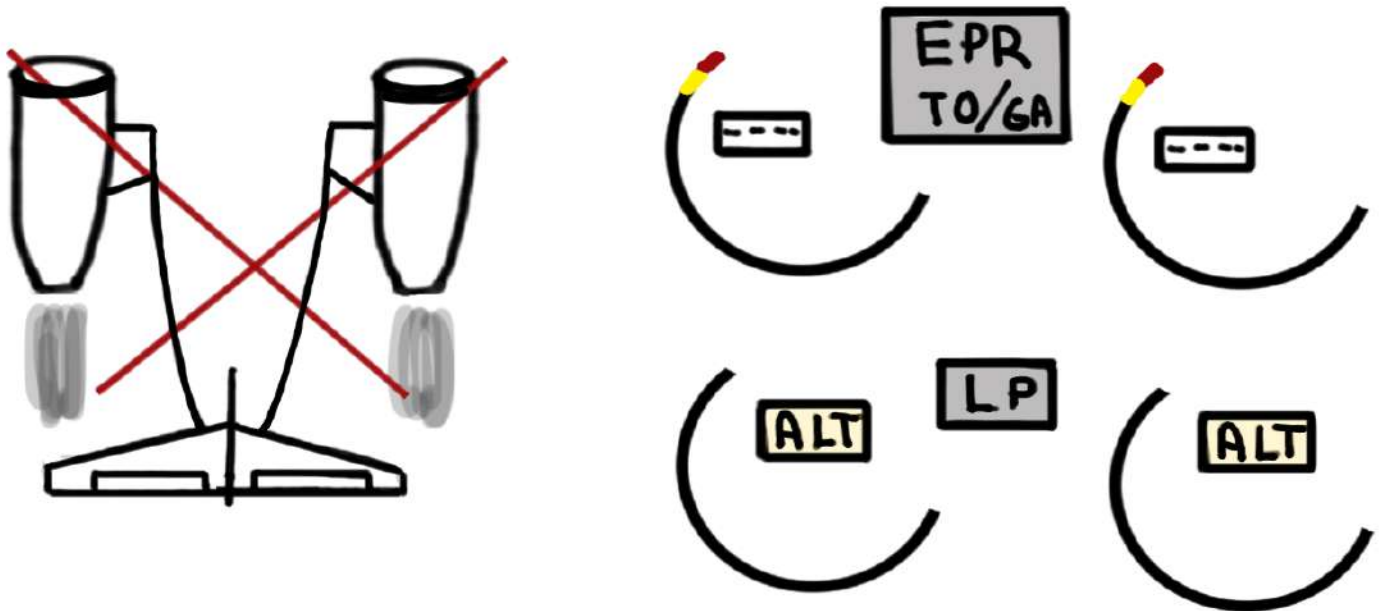

MINIMUM OIL TEMPERATURE FOR TAKEOFF: +20°C

MAXIMUM TGT: 900°C

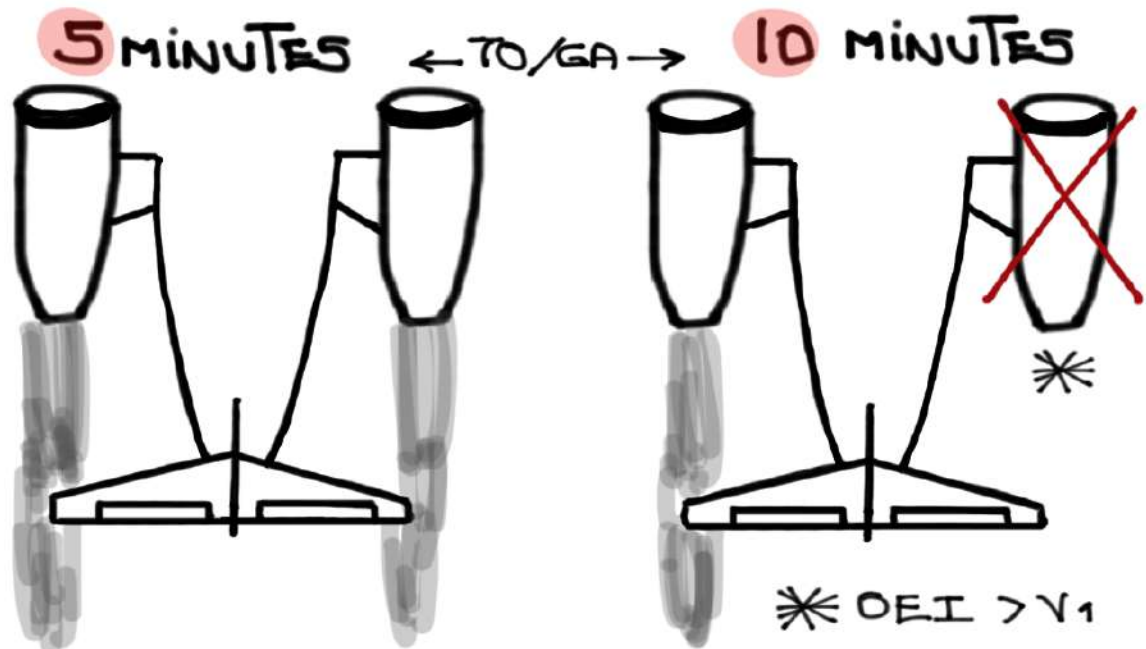

ENGINE BLEEDS OFF - TAKEOFF

- QRH - ALTERNATE NORMALS
BLEED OFF TAKEOFF PROCEDURE

NG-11

- APU BLEED AIR \nearrow 1,500' AGL

1.4% GROSS WEIGHT INCREASE

PERFORMANCE HANDBOOK

PA-47, NOTE 3

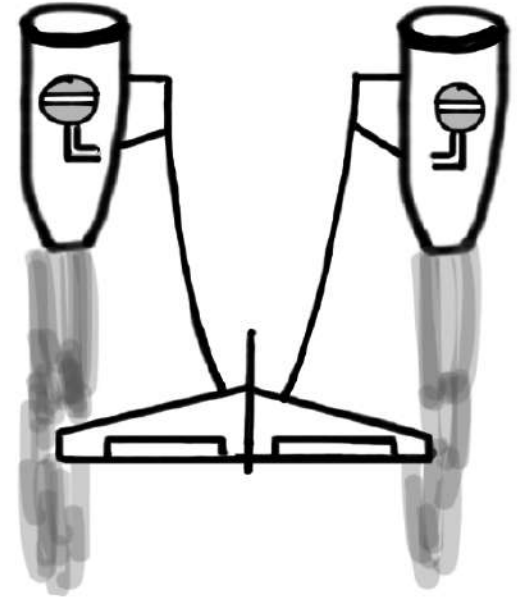

ENGINE LIMITATIONS - TAKEOFF

ENGINE X-WIND TAKEOFF LIMITATION

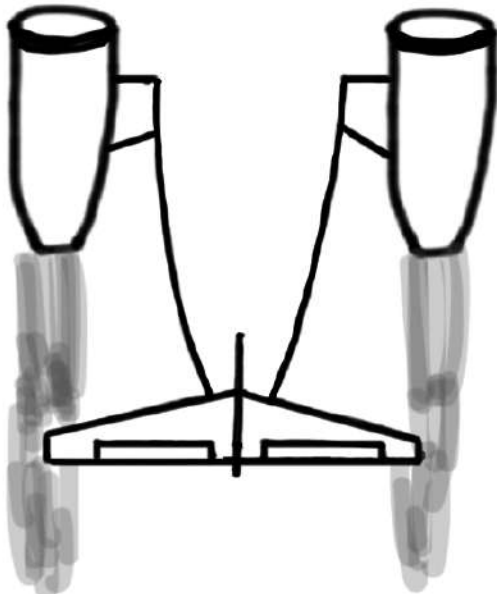

④ SLAM ACCELERATION
TO EPR (RATED OR PIEX)
(≤ 5 SECONDS)
AUTO THROTTLE OK

③ FORWARD SPEED ≥ 20 KTS

② $\leq 66\%$ LP RPM

①



≥ 20 KTS X-WIND

* Add 600' TO REQUIRED
FIELD LENGTH

ENGINE LIMITATIONS - Inflight

MAXIMUM CONTINUOUS THRUST (MCT) **860° C** TGT

START ENVELOPE

\leq **25,000'**

STARTER ASSIST Windmill START
 \leq **250** KCAS \geq **251** KCAS

MAXIMUM TGT **850** °C

NOTE: NO FADEC
PROTECTION

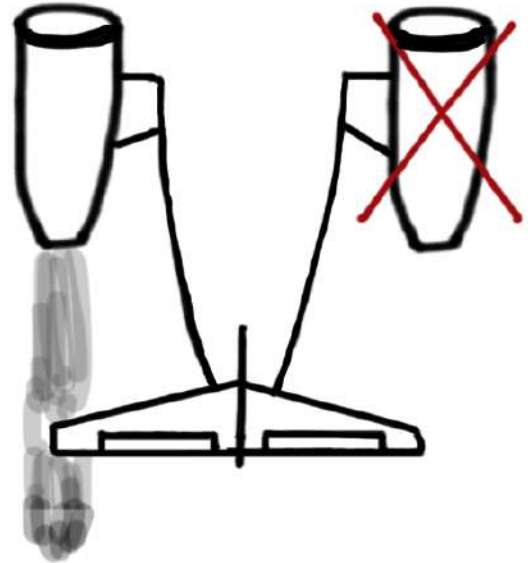

ENGINE LIMITATIONS - LANDING

THRUST REVERSERS

70% LP - **30** SECONDS

idle REVERSE by **60** KCAS

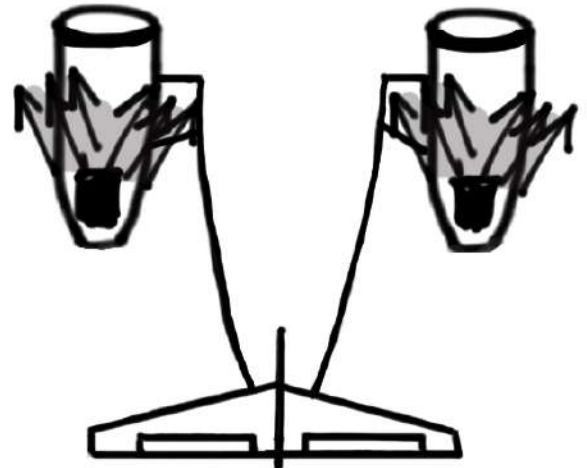

ENGINE LIMITATIONS - TAXI IN / SHUTDOWN

NOTE: IT IS RECOMMENDED TO OPERATE ENGINES AT IDLE FOR THREE (3) MINUTES BEFORE SHUTDOWN

ENGINE FAILURE

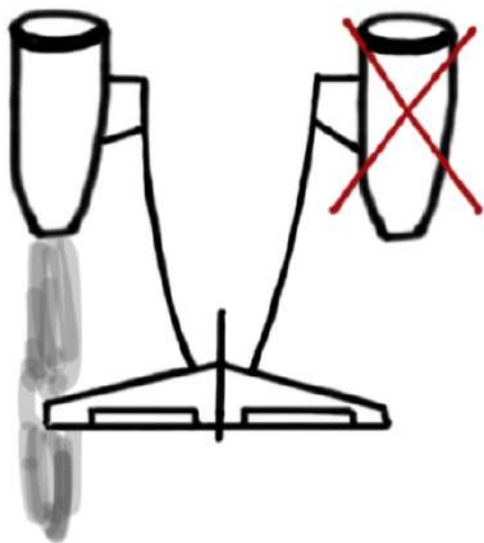

DO NOT ATTEMPT RESTART:

- FIRE
- FOD
- FROZEN

RESTART - YES OR NO?

YES ? $\left\{ \begin{array}{l} \text{AIRSTART - AUTOMATIC} \quad \checkmark\text{-list} \quad *$
AIRSTART - WINDMILLING $\checkmark\text{-list} \quad * \quad *$

* NO FADEC PROTECTION DURING START

* ICING CONDITIONS

NO ? ENGINE SHUTDOWN IN FLIGHT $\checkmark\text{-list}$

REMINDER: these system notes are intended for study purposes only. Always refer to official Gulfstream manuals and other approved references when operating your aircraft.

NOTE: these system notes are updated from time to time and what is posted on Code450.com will always be the most recent version.

Questions, comments or errors...please do send me an email:
ivan@code7700.com

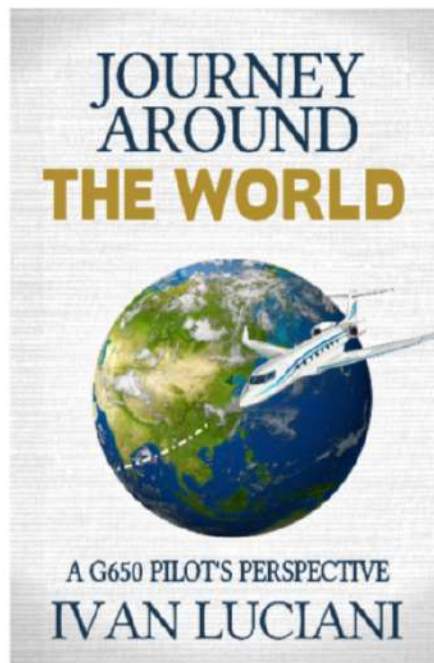
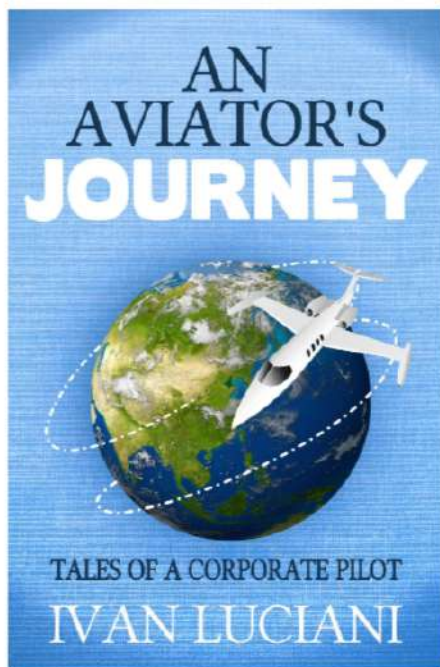

Thank you!