

G600 PNEUMATIC SYSTEM

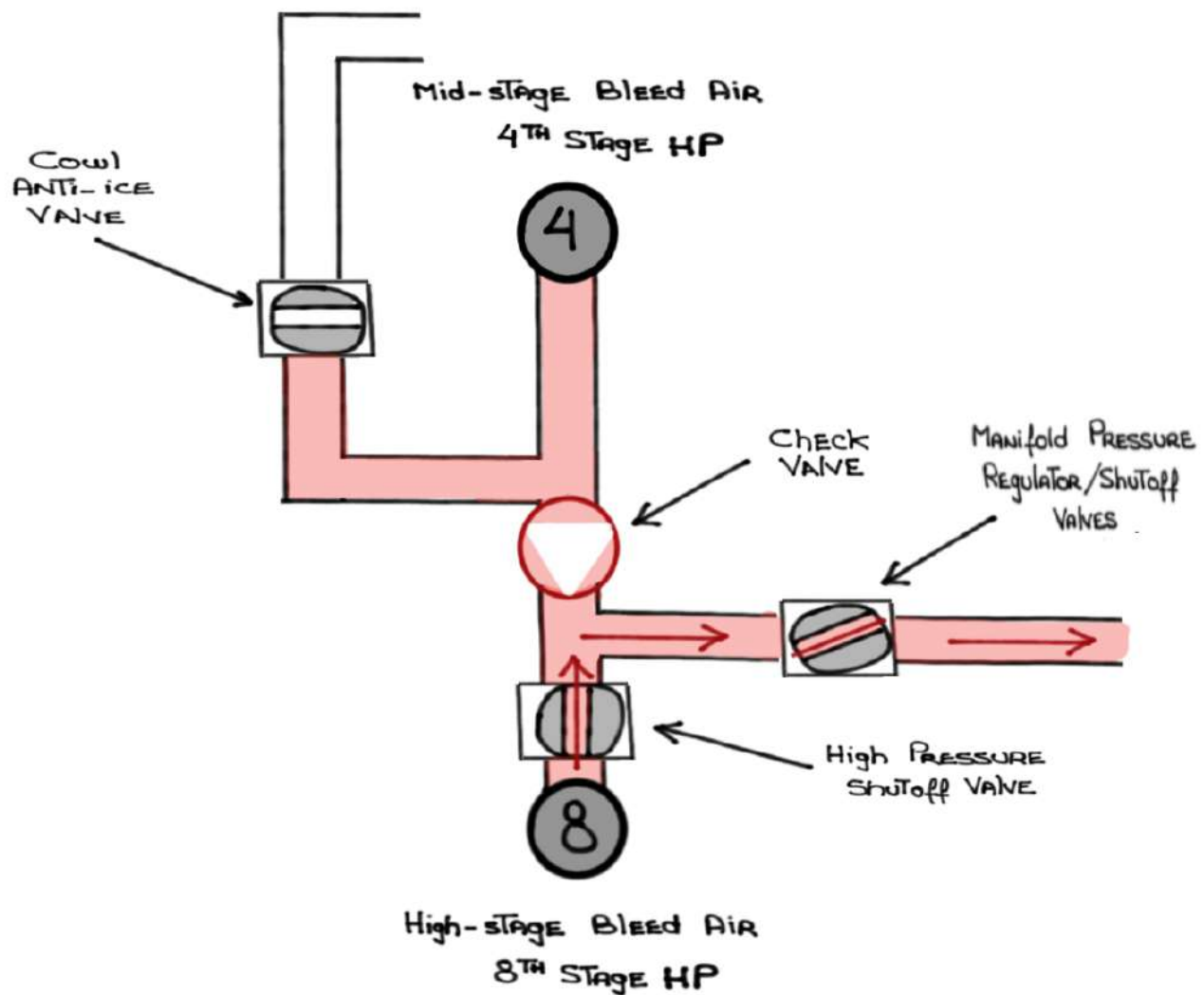

For study purposes only

The PNEUMATIC System is about The generation of High PRESSURE/TEMPERATURE Air from:

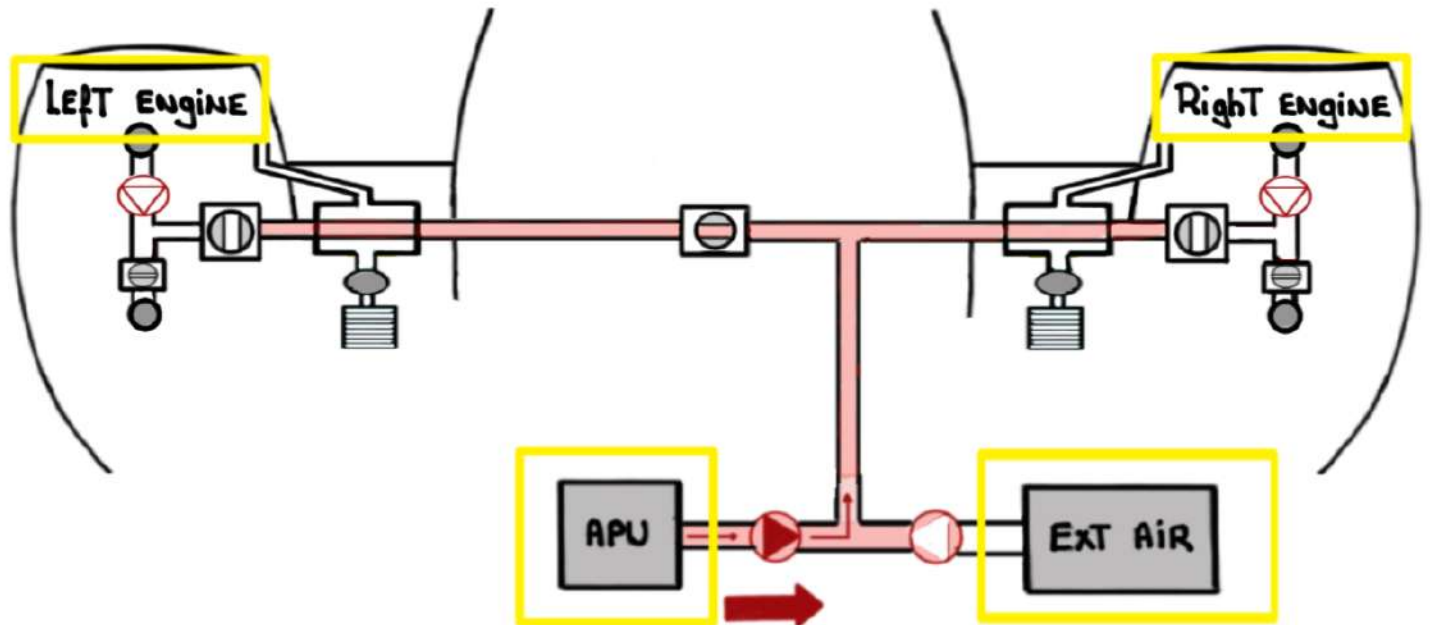

High PRESSURE/TEMPERATURE Air is utilized by:

- ENGINE STARTING SYSTEM
- Cowl/Wing ANTI-ICE SYSTEMS
- Air CONDITIONING/PRESSURIZATION SYSTEMS
- POTABLE WATER SYSTEM
- TAT PROBE AIRFLOW (ground only) To ELIMINATE RADIANT HEAT
- OTHER SYSTEMS

PNEUMATIC SYSTEM Sub-COMPONENTS

- BLEED AIR CONTROLLERS (BACs)

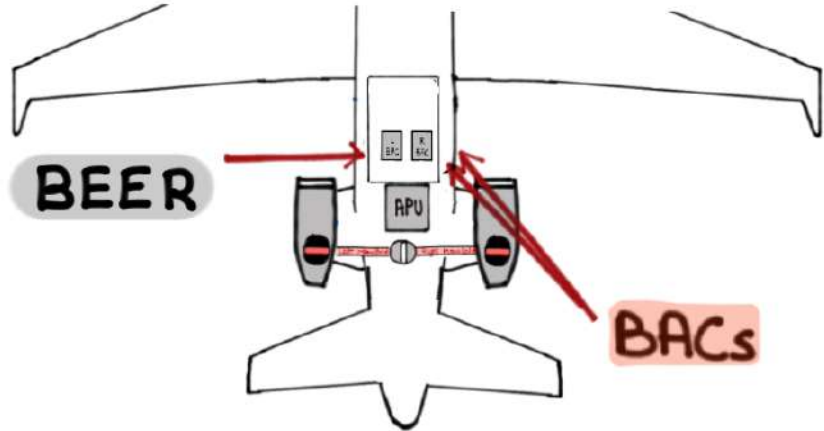
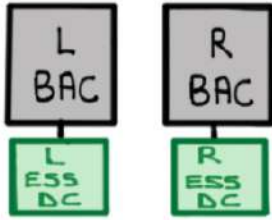

- ISOLATION VALVE

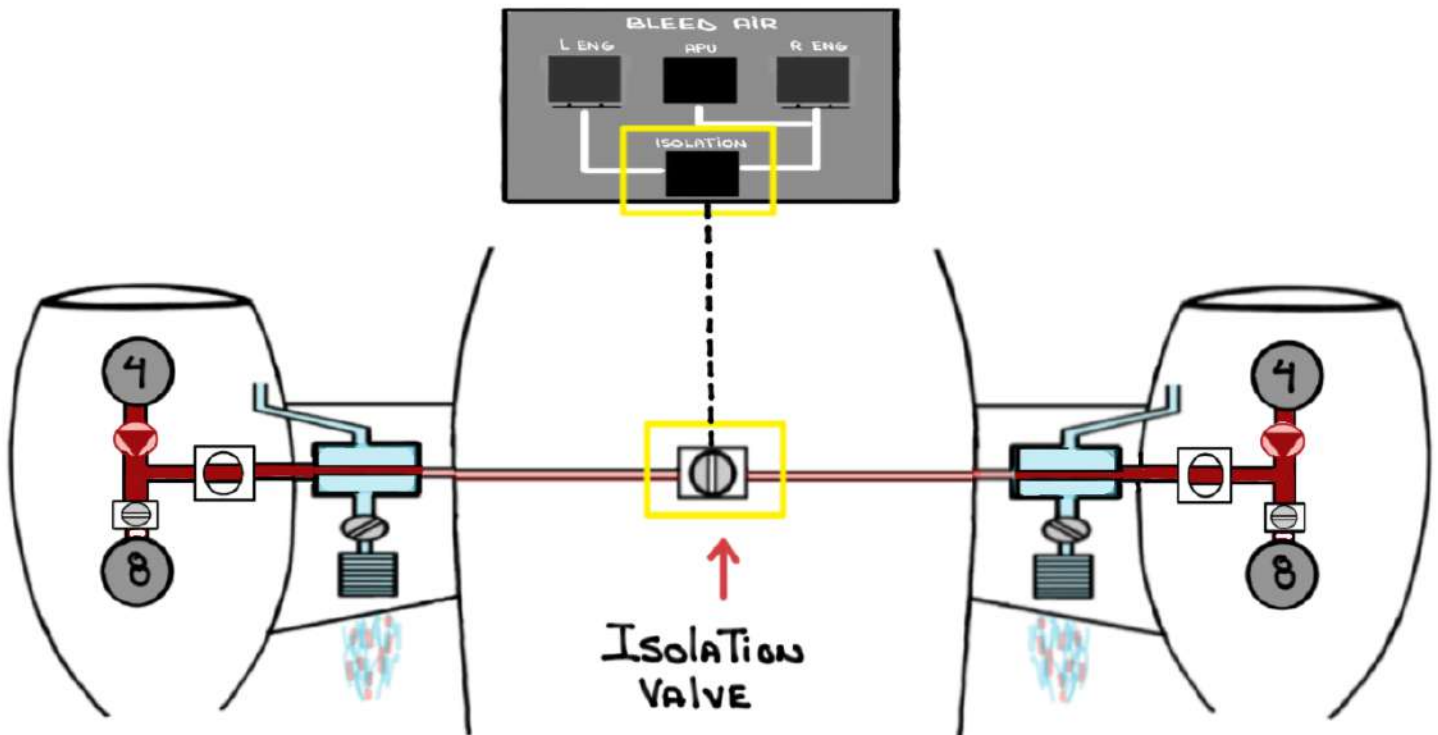

- PRESSURE REGULATING / SHUTOFF VALVES (PRSOV)

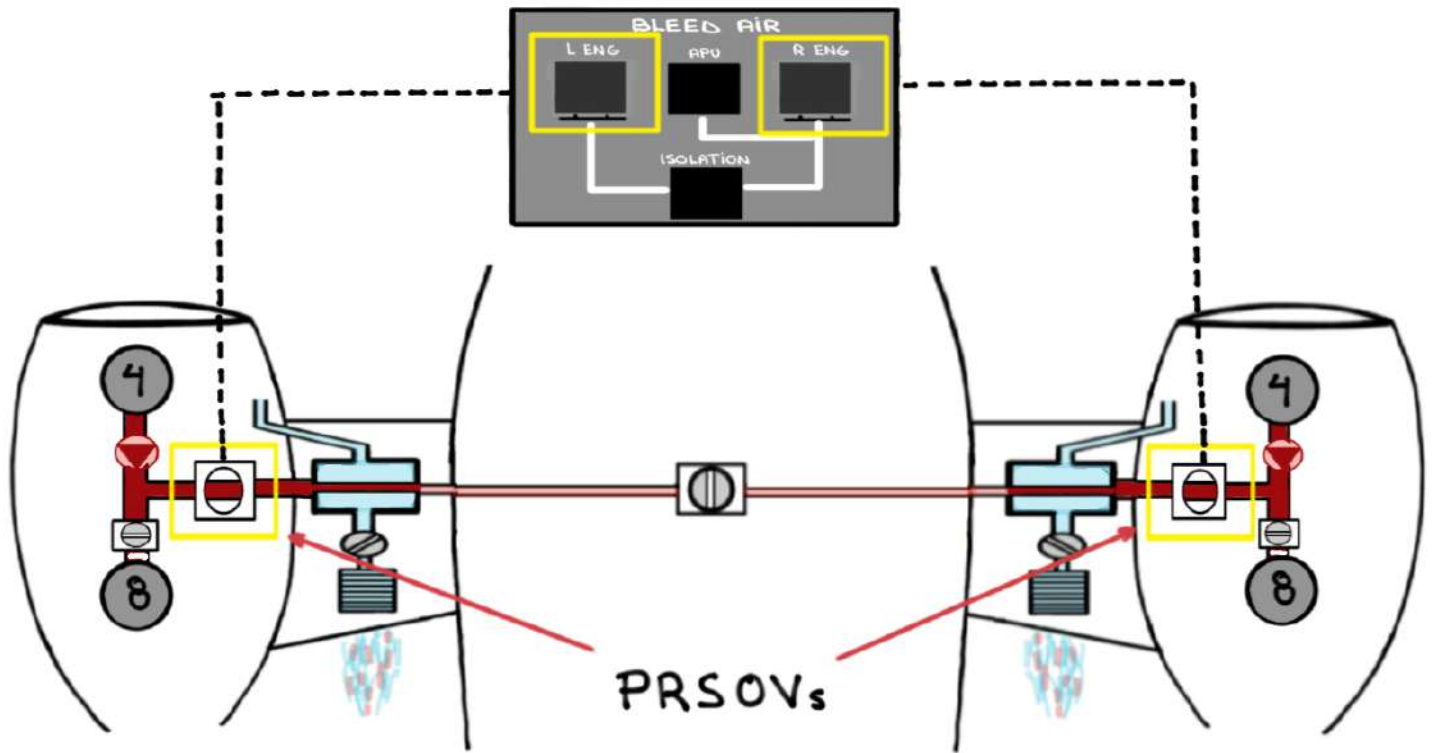

- High-PRESSURE SHUTOFF VALVES (HPSOV)

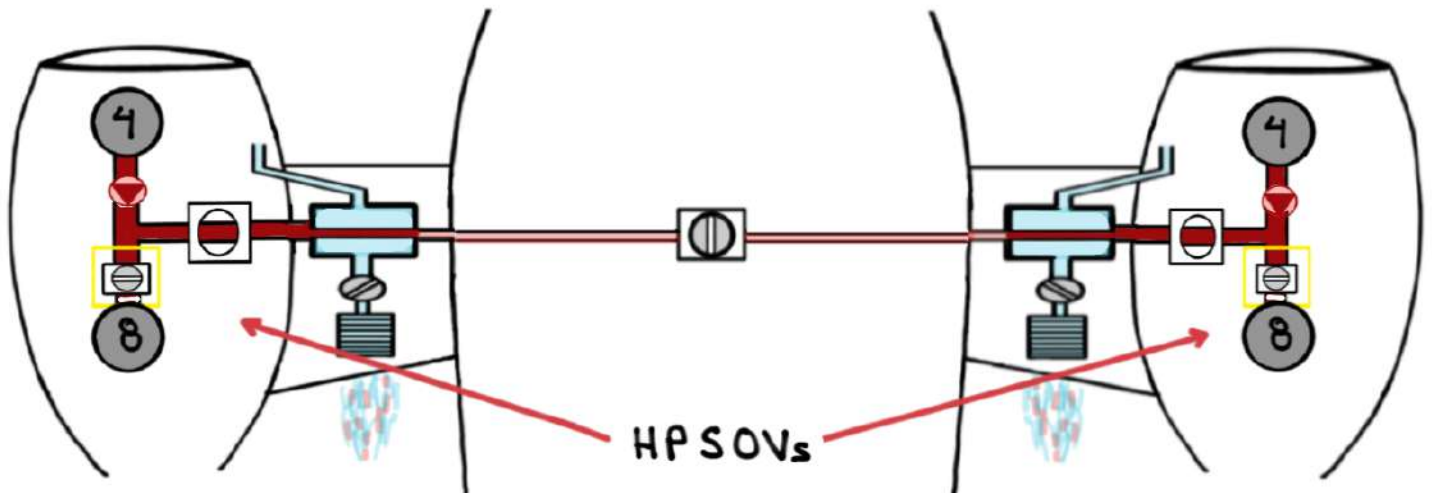

- FAN Air Valves

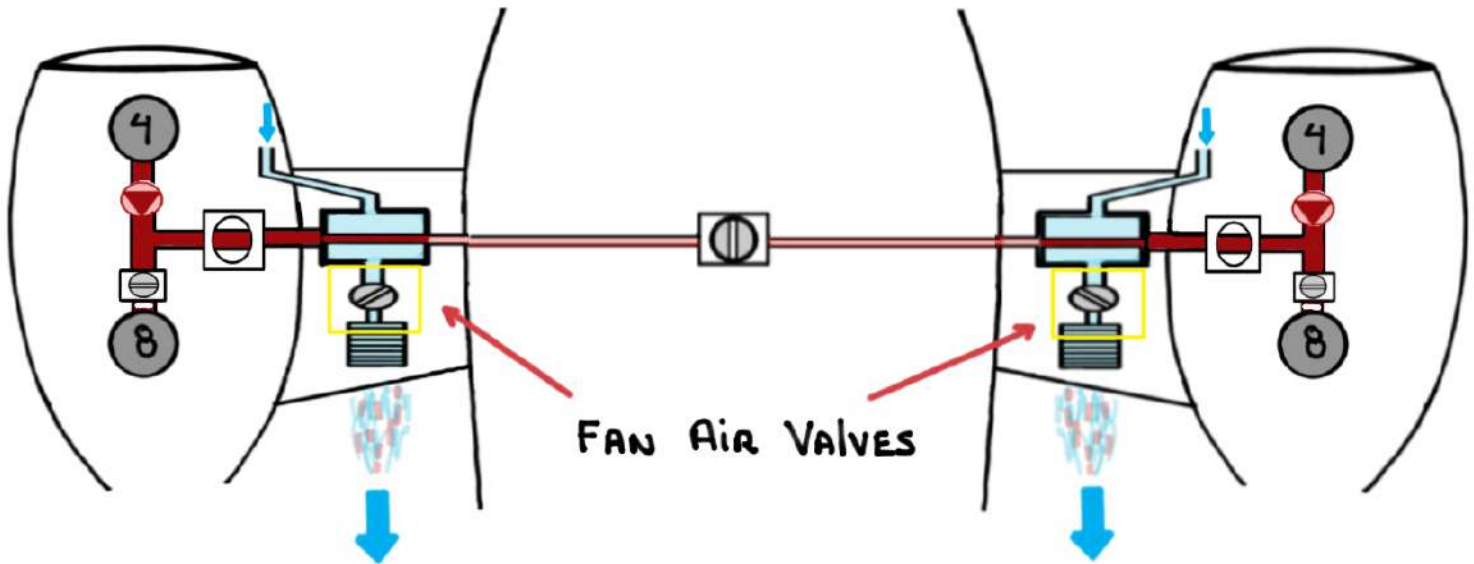

- PRESSURE/TEMPERATURE SENSORS

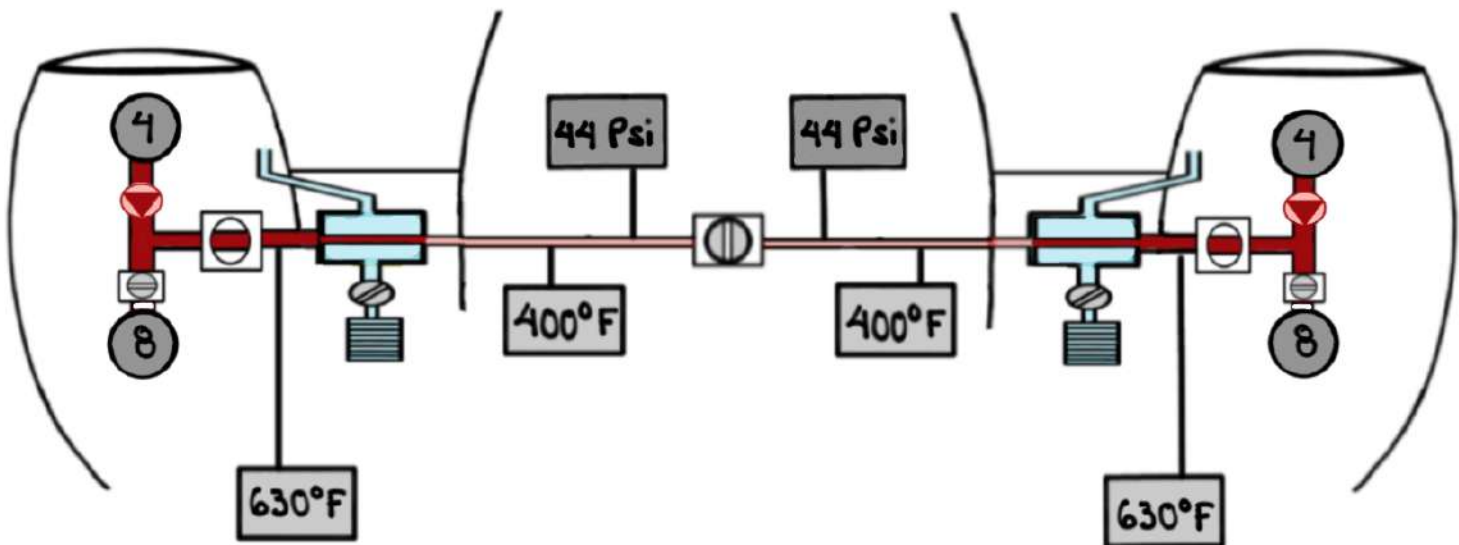

- Check VALVES (ONE-WAY flow)

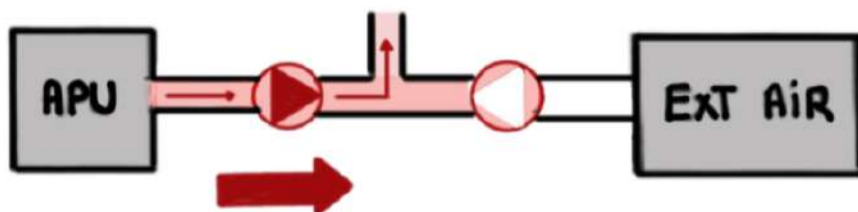
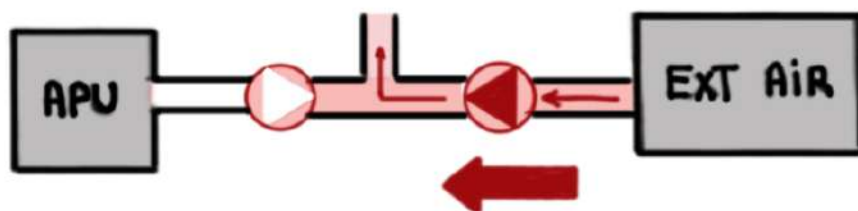

Mid STAGE Check VALVES (NON-RETURN VALVES)

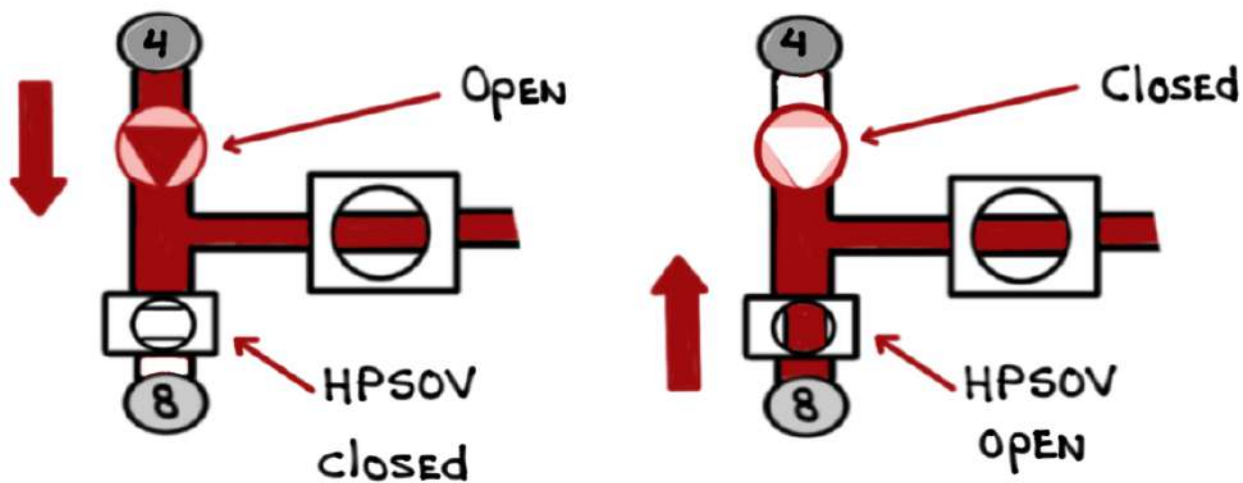

HPSOV, if OPEN, allows higher PRESSURE FROM THE 8TH STAGE PORT TO CLOSE THE 4TH STAGE CHECK VALVE

BLEED AIR CONTROLLERS (BACs)

The PNEUMATIC SYSTEM is REGULATED by two (2) IDENTICAL AND INTERCHANGEABLE MICROPROCESSORS

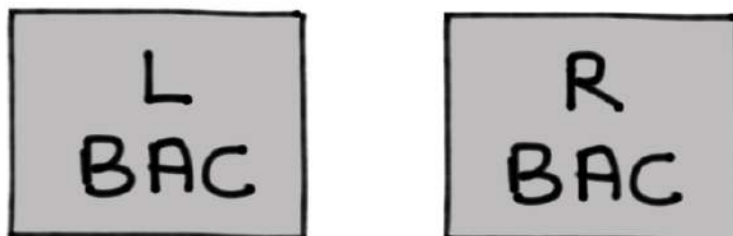

- THE BACs ARE THE BRAINS OF THE SYSTEM
- THE BACs CONTROL MOST PNEUMATIC FUNCTIONS VIA TWO (2) SEPARATE AND INDEPENDENT MANIFOLDS
- PNEUMATIC MANIFOLDS CAN BE CONNECTED BUT ARE NORMALLY OPERATED IN ISOLATION VIA AN ISOLATION VALVE

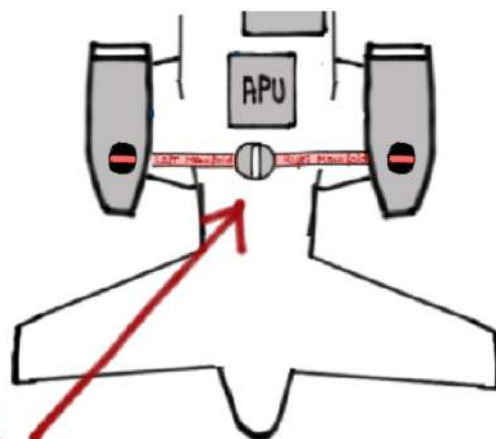
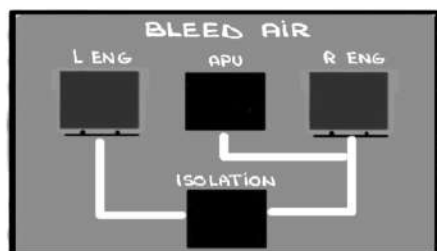

ISOLATION VALVE
CLOSED

- This design PREVENTS TOTAL loss of PNEUMATIC AIR IN THE EVENT of a LEAK in ONE of THE MANIFOLDS

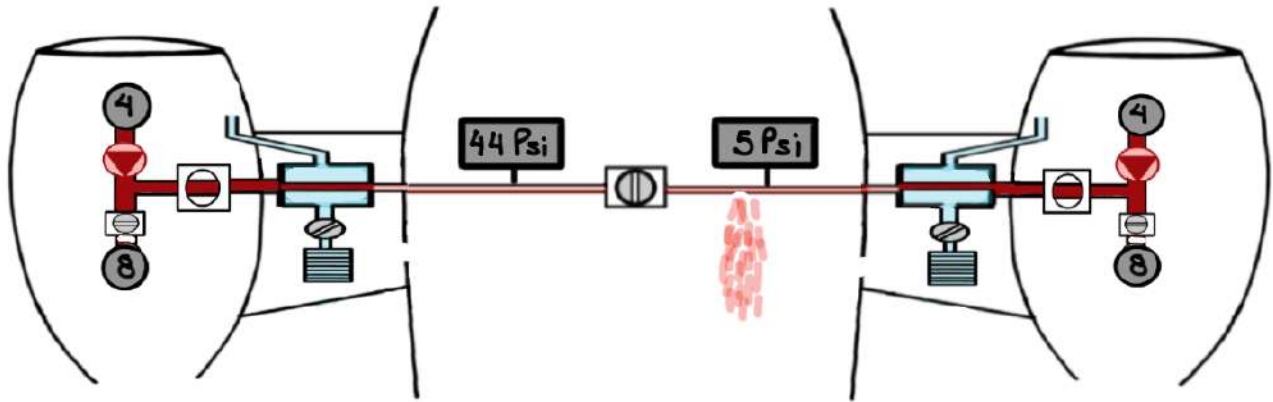

- The **L BAC** **R BAC** ARE LOCATED IN THE FORWARD RIGHT WALL OF THE BAGGAGE COMPARTMENT

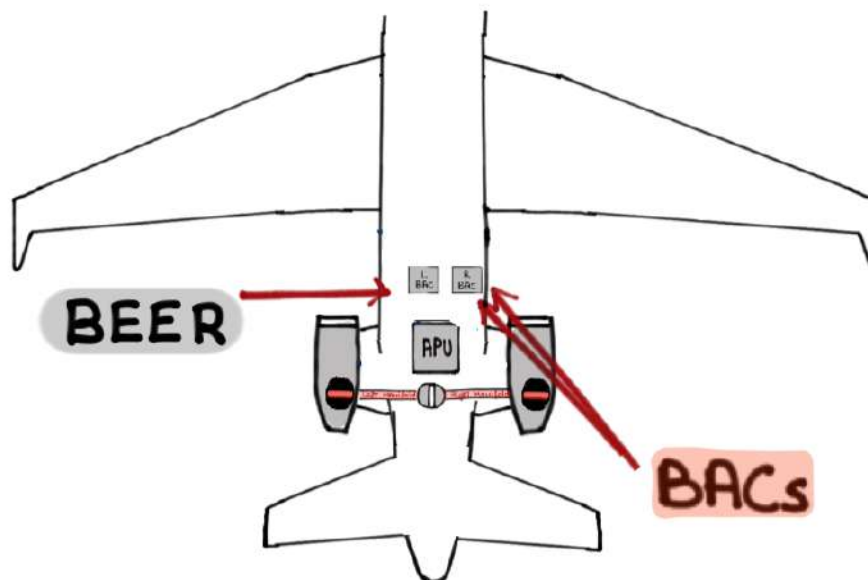

- The L
BAC R
BAC RECEIVE DATA AND Cockpit input
FROM THE following SOURCES:

DATA input:

- AIRCRAFT ALTITUDE
- STATIC AIR TEMPERATURE (SAT)
- ENGINE LP RPM
- PRECOOLER INLET TEMPERATURE
- PRECOOLER OUTLET TEMPERATURE
- BLEED MANIFOLD PRESSURE
- WING ANTI-ICE TEMPERATURE

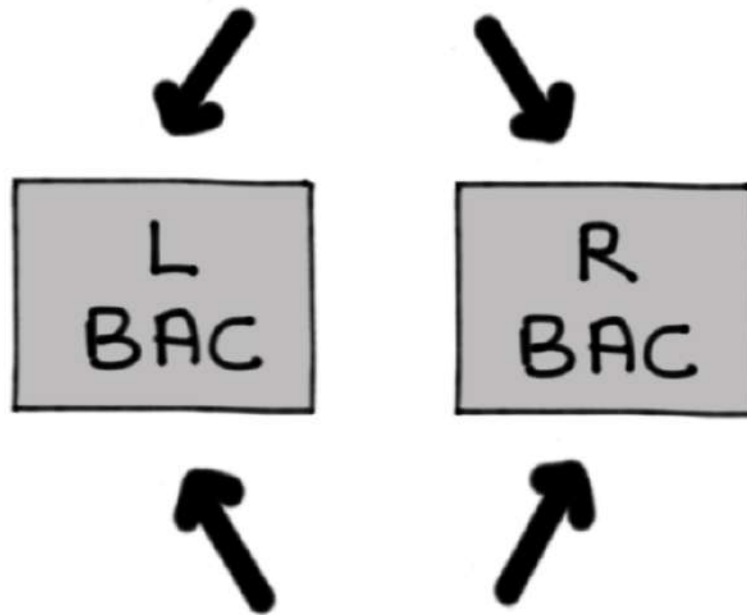

Cockpit input:

- L/R ENGINE BLEED SELECTION
- WING ANTI-ICE SELECTION
- L/R ECS PACK SELECTION
- ENGINE START SWITCH

- The L
BAC R
BAC PROCESS DATA AND Cockpit input
AND BASED ON SYSTEM REQUIREMENTS COMMAND
THE following VALVES TO MODULATE AS REQUIRED:



High-PRESSURE ShutOff VALVES (HPSOV)
∝
FAN AIR VALVES

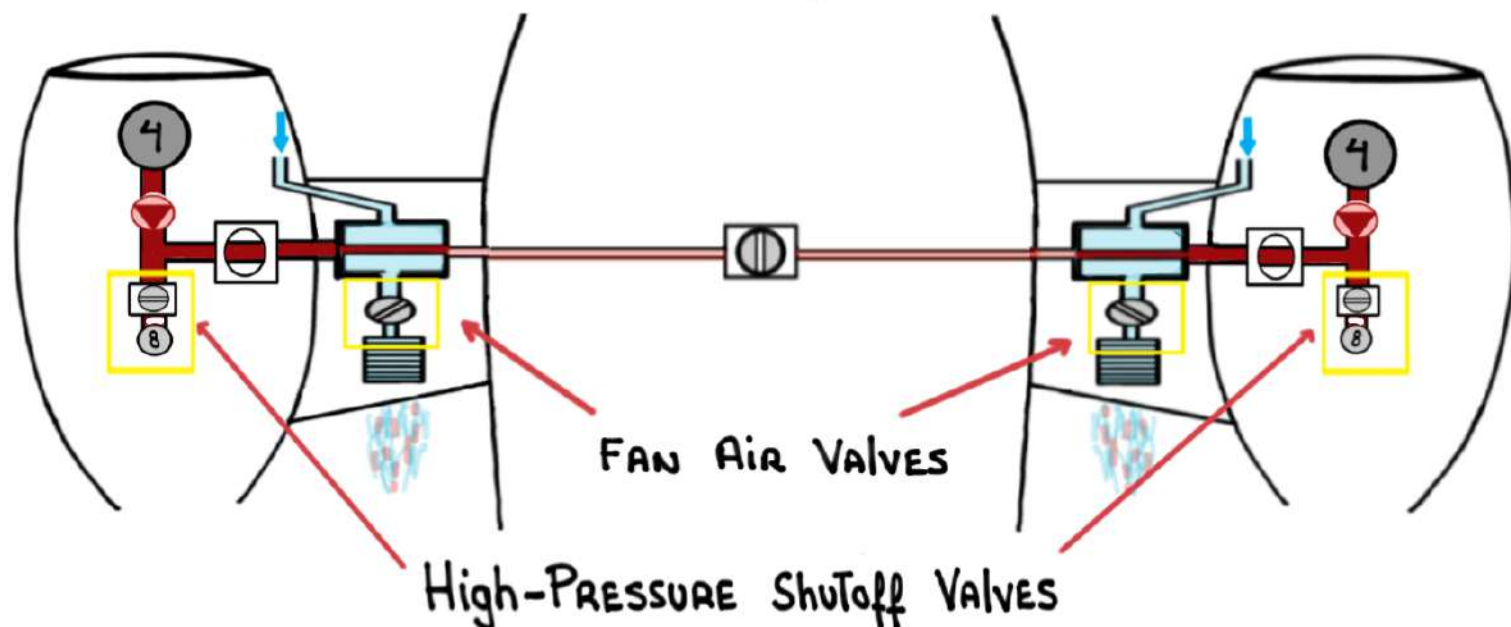

- The L
BAC R
BAC MODULATE THESE VALVES IN ORDER
TO PRODUCE PROPER AIR BASED ON SPECIFIC SYSTEM
REQUIREMENTS

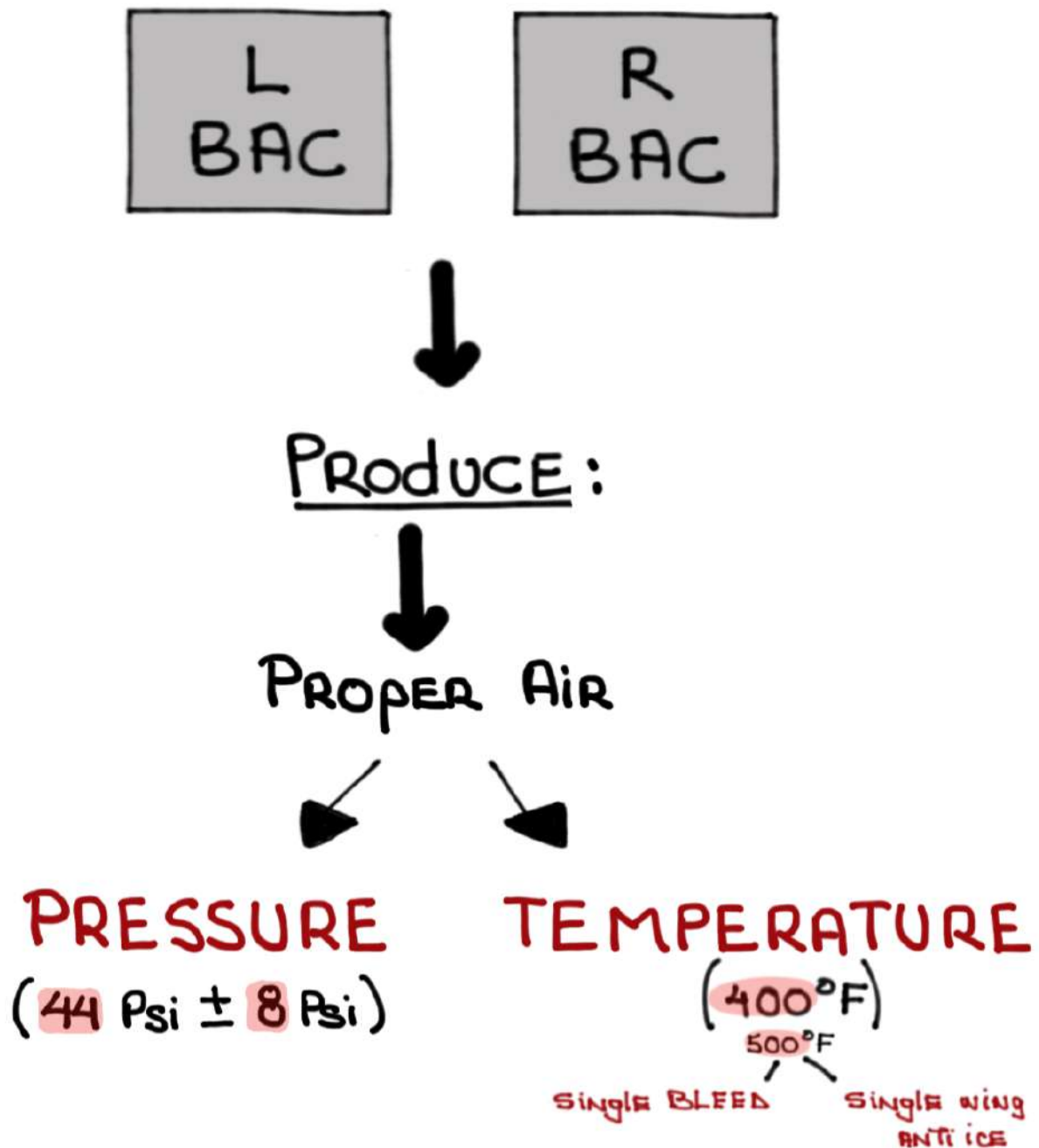

MAIN ENGINES BLEED AIR

① Mid-STAGE bleed air: 4TH STAGE of The HP COMPRESSOR.

If INSUFFICIENT, in TERMS of PRESSURE/TEMPERATURE,
it is AUGMENTED by 8TH STAGE bleed air

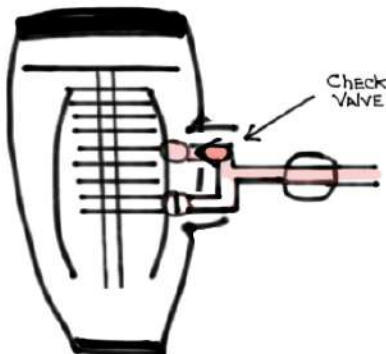
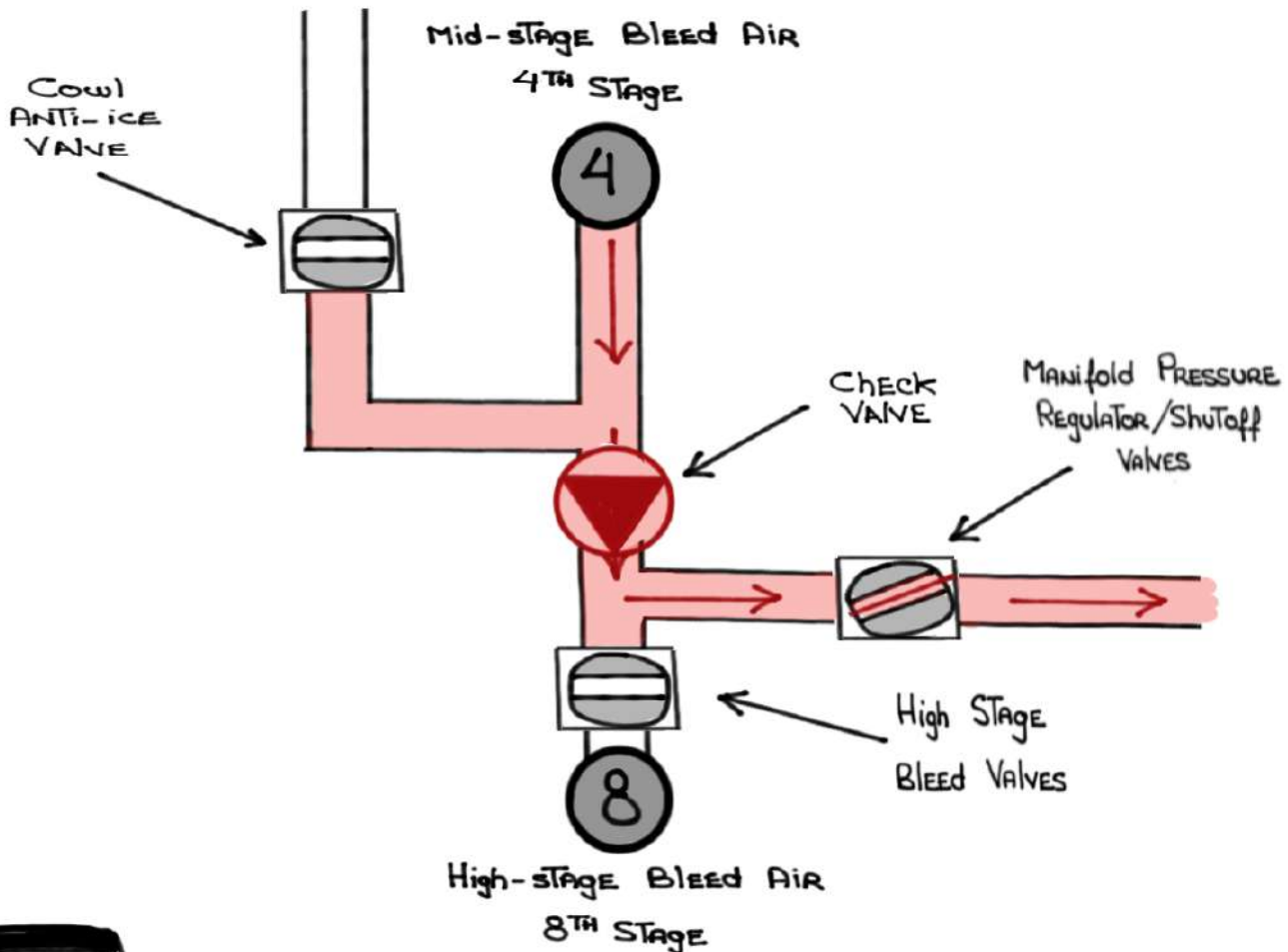

4TH STAGE check valve:

PREVENTS higher PRESSURE 8TH STAGE
bleed FROM ENTERING THE 4TH STAGE PORT

② High-Stage bleed air: 8TH STAGE OF THE HP COMPRESSOR

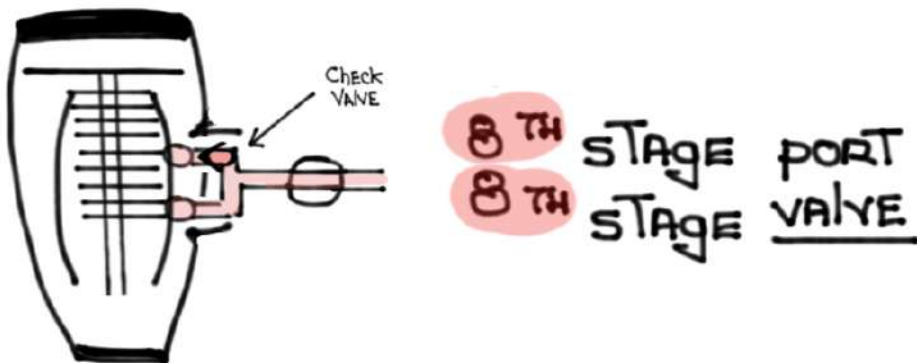
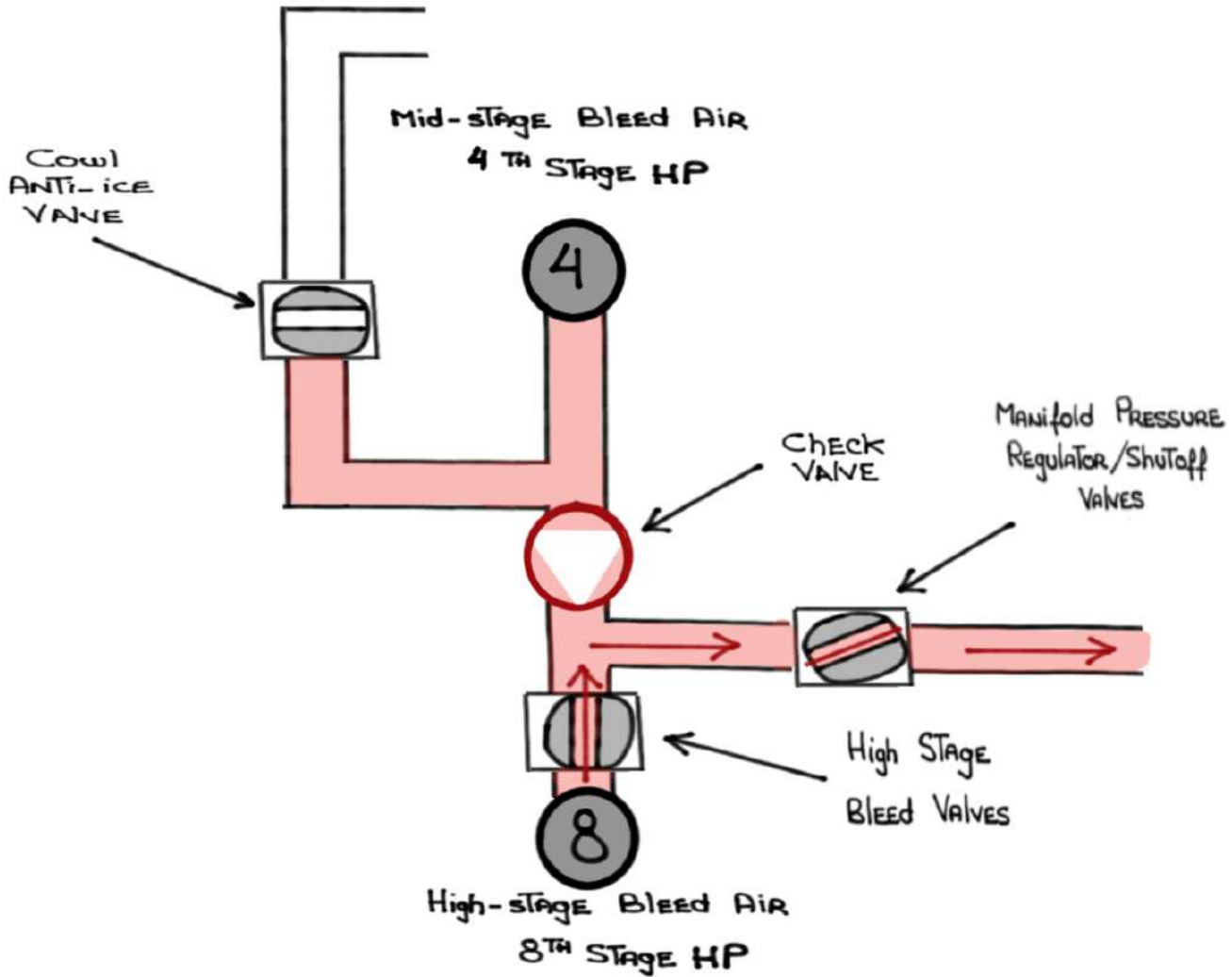

APU BLEED AIR

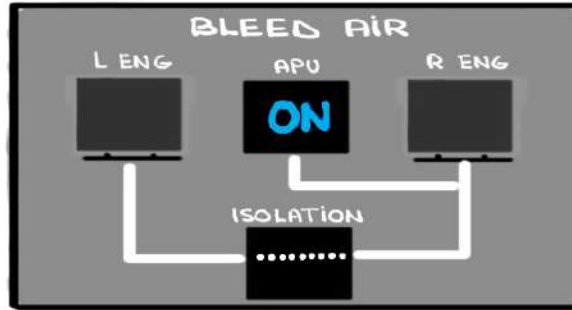

The APU's Load Control Valve (LCV) allows High PRESSURE/TEMPERATURE AIR INTO THE LEFT AND RIGHT PNEUMATIC MANIFOLDS

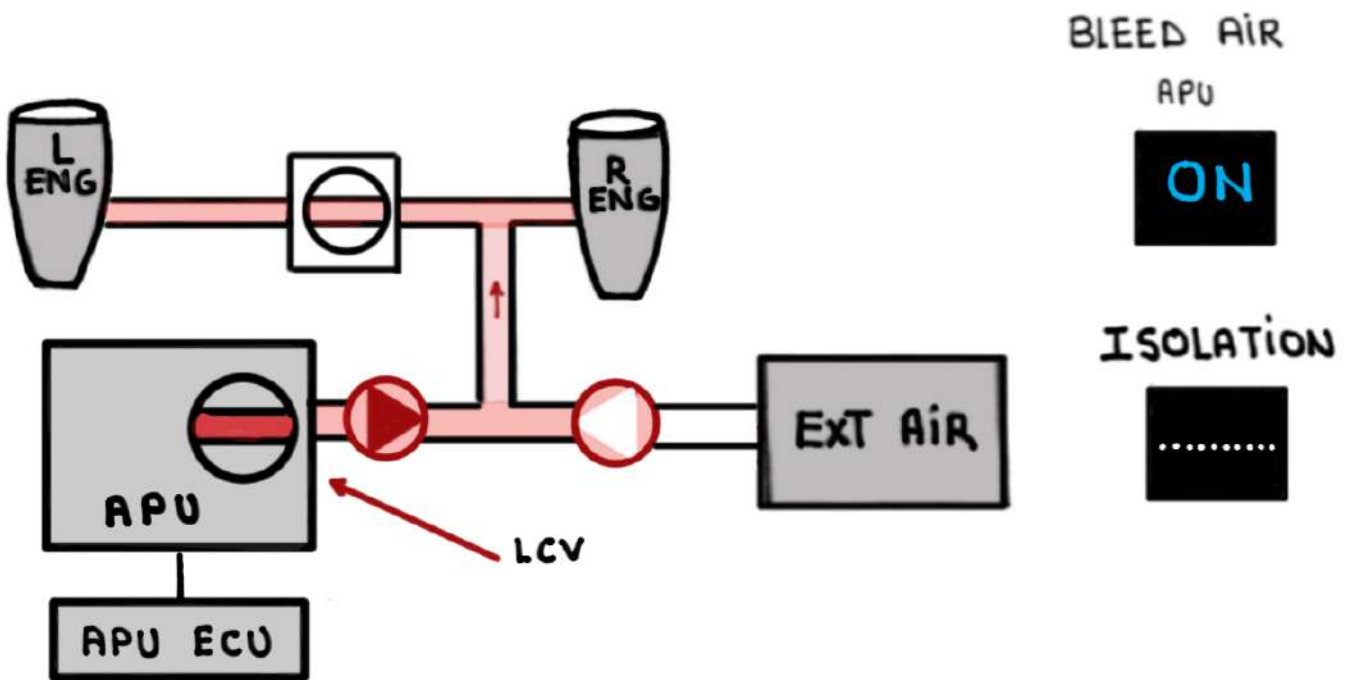

APU bleed air plumbing CONNECTS DIRECTLY TO THE **R** MANIFOLD

SELECTION OF APU BLEED AIR OPENS THE ISOLATION VALVE. THIS ALLOWS BLEED AIR TO ENTER THE L MANIFOLD

- WOW-**G**
- APU STABILIZED AT **100%** RPM
- ONE **(1)** MINUTE DELAY IF EGT < **149°C**

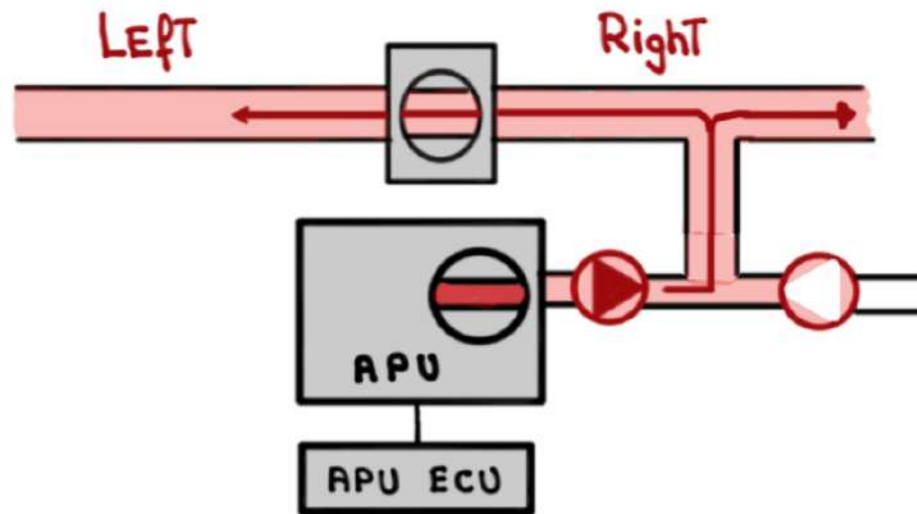

APU BLEED AIR IS AVAILABLE IMMEDIATELY TO RESTART AN ENGINE IN FLIGHT - WOW-**A**

A flapper-type check valve  OPENS WHEN APU OR EXTERNAL AIR PRESSURE IS GREATER THAN MANIFOLD PRESSURE. THIS ALLOWS THE APU OR EXTERNAL AIR SOURCE TO PRESSURIZE THE PNEUMATIC MANIFOLD

THE CHECK VALVE  PROTECTS THE APU FROM REVERSE FLOW ORIGINATING FROM THE ENGINE

EXTERNAL AIR *

- PROVIDES AIR FOR MAIN ENGINE START WHEN THE APU IS UNAVAILABLE
- CONNECTS TO THE **Right** BLEED AIR MANIFOLD

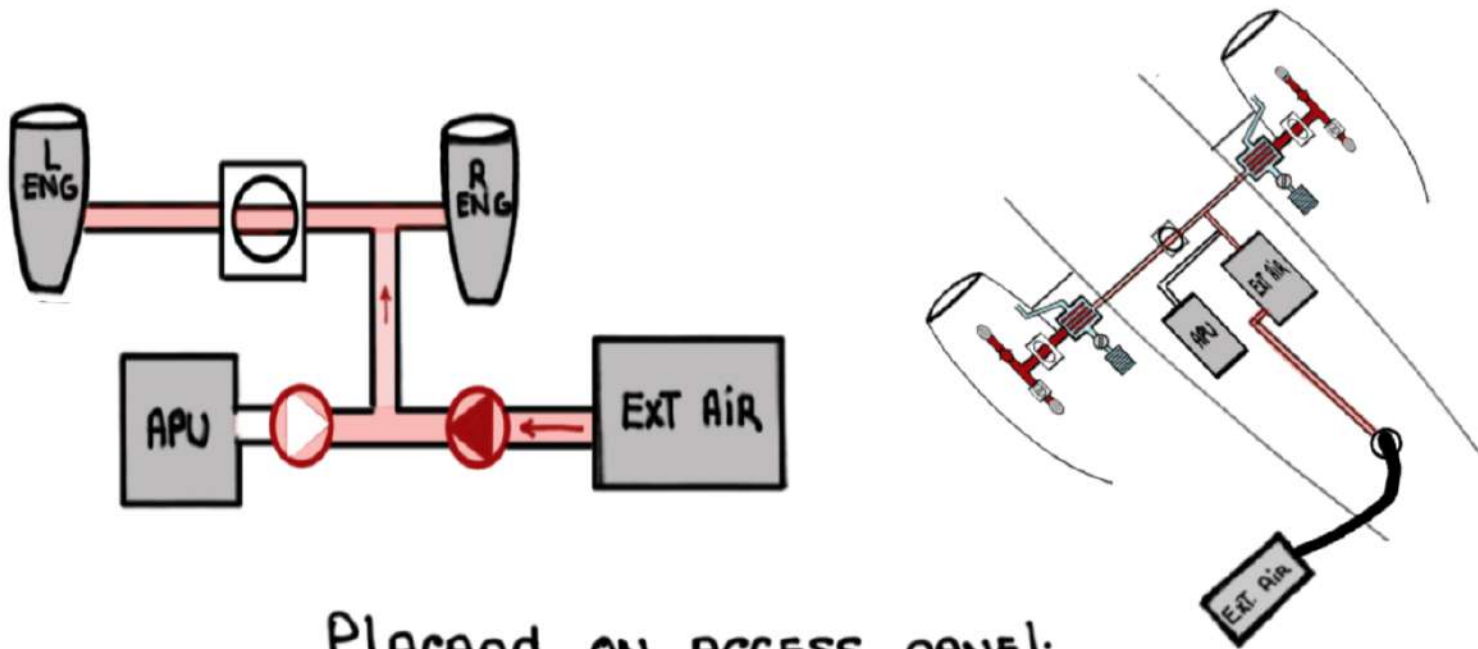

PLACARD ON ACCESS PANEL:

DO NOT CONNECT WITHOUT
ELECTRICAL POWER ON

- DC POWER IS REQUIRED TO OPEN THE ISOLATION VALVE AND THE **L PACK** **R PACK**
- PREVENTS DAMAGE TO THE PACKS DUE TO UNREGULATED AIR

ISOLATION VALVE

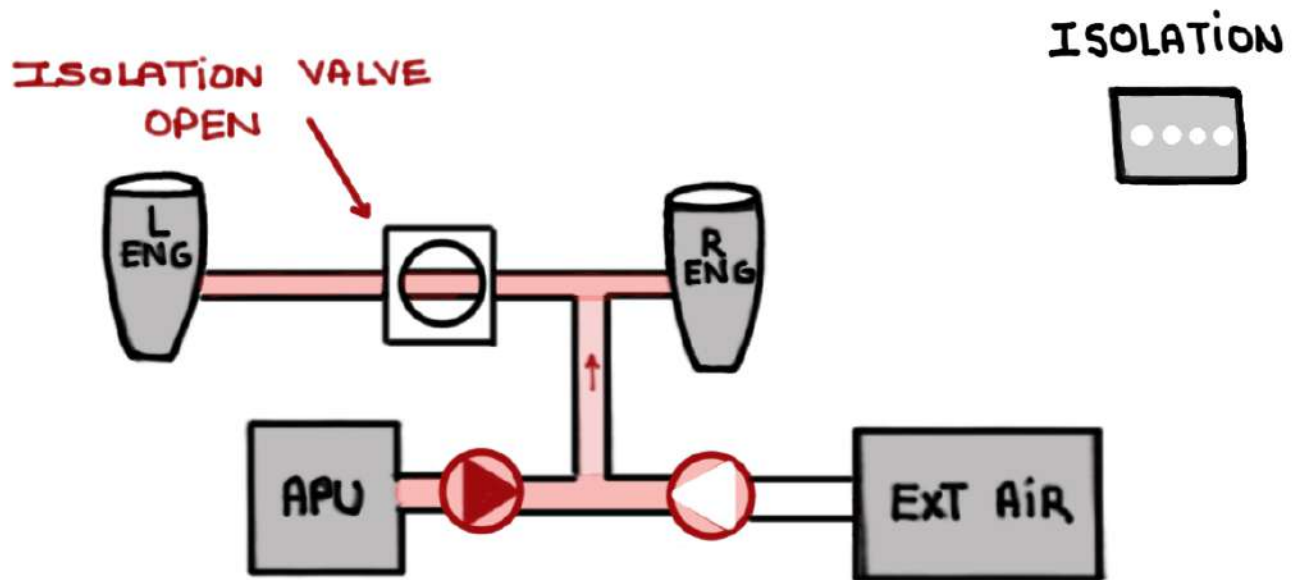

- POWERED by L
ESS
DC bus
- ELECTRO-PNEUMATIC VALVE. IT REQUIRES:
 - ELECTRICAL POWER TO OPERATE
 - PNEUMATIC PRESSURE TO OPEN
- FAILS FROZEN (i.e., its LAST position)

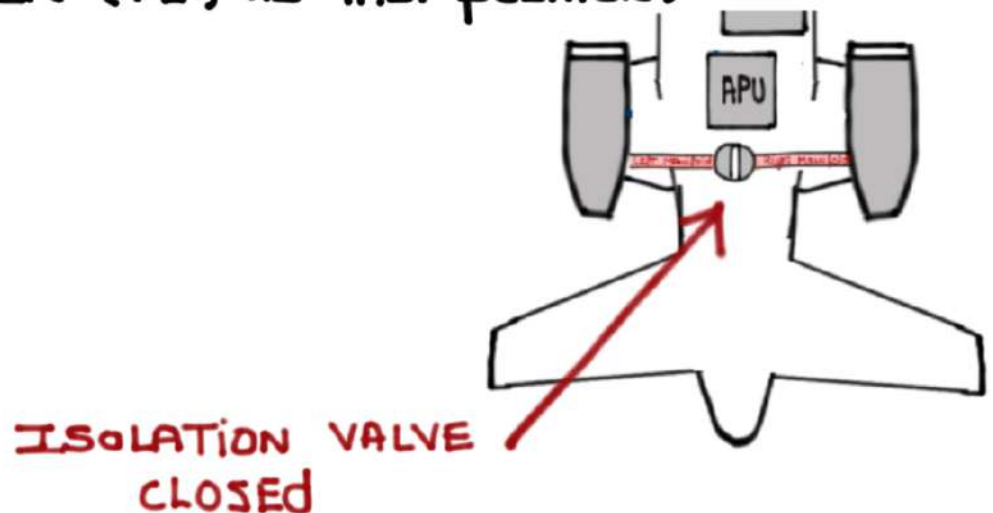

- Without L
ESS
DC bus power it will NOT OPERATE
- LOCATED IN THE TAIL COMPARTMENT

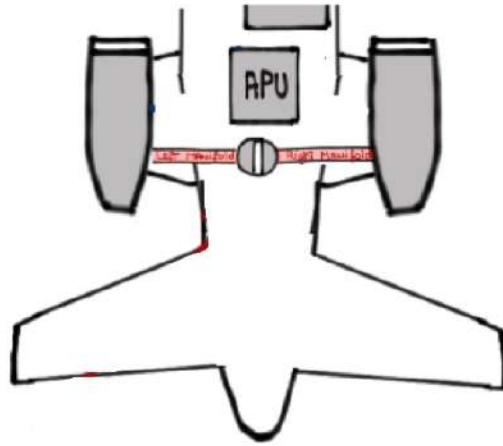

ISOLATION

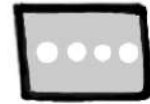

- OPENS :

①



② L/R CRANK switch ON (OHPTS)

③ APU BLEED AIR ON

④ MANUALLY SELECTED OPEN when directed by THE CHECKLIST

MANIFOLD PRESSURE REGULATOR / SHUTOFF VALVES

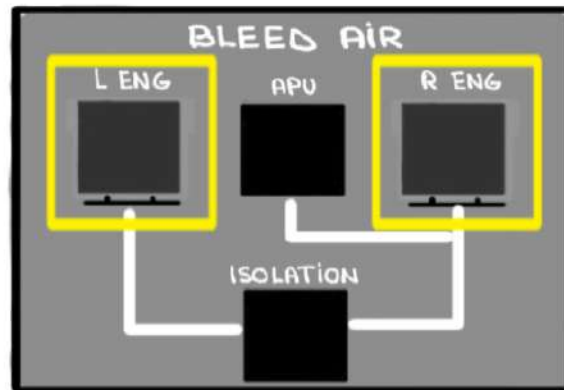

- ELECTRO - PNEUMATIC VALVES:
 - ELECTRICAL POWER TO OPERATE
 - PNEUMATIC PRESSURE TO OPEN
- CONTROLLED VIA THE LEFT AND RIGHT ENGINE SWITCHES
- FUNCTION AS **ON/OFF** VALVES TO THE PNEUMATIC MANIFOLD
- MODULATE AS NEEDED TO MAINTAIN **14-52** psi BASED ON DEMAND VARIABLES

- LOCATED ON EACH ENGINE

- Without L
ESS
DC R
ESS
DC bus POWER will NOT OPERATE

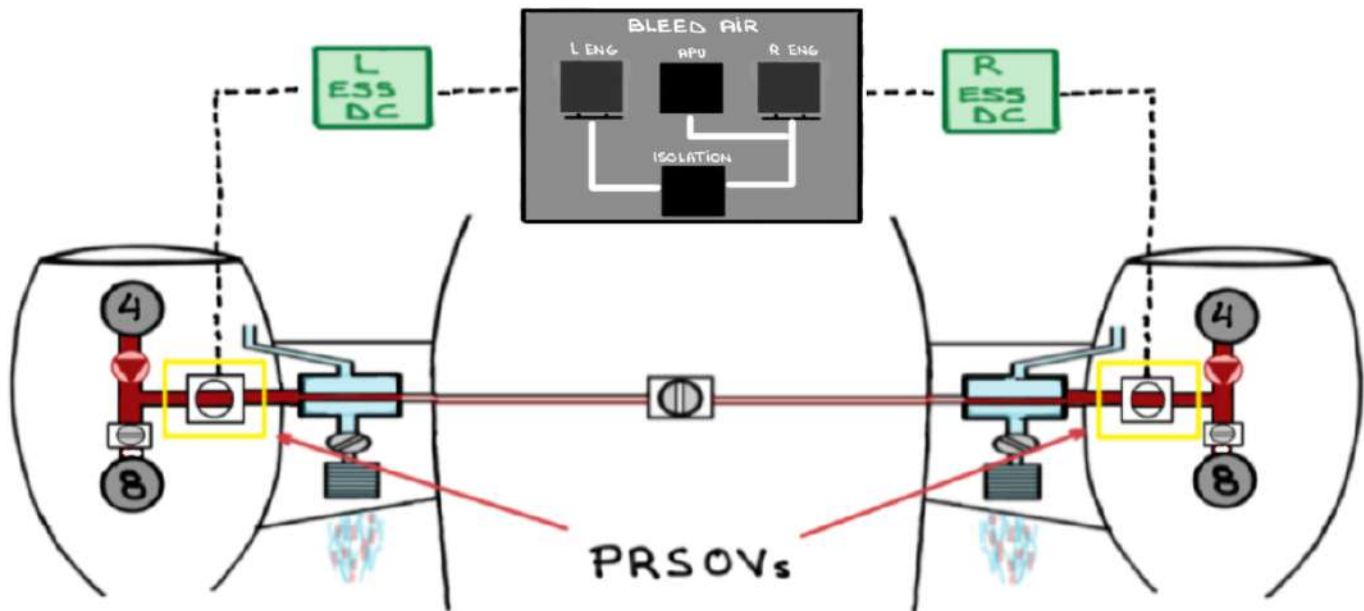

"TO MAKE SURE you don't HAVE
TOO MUCH PRESSURE"

High STAGE BLEED AIR VALVES

8TH STAGE HP COMPRESSOR

- LOCATED ON EACH ENGINE
- COMMANDED TO MODULATE AS NEEDED BY THE BACs WHEN MID-STAGE BLEED AIR (4TH) IS INSUFFICIENT
- Spring-loaded AND fail CLOSED

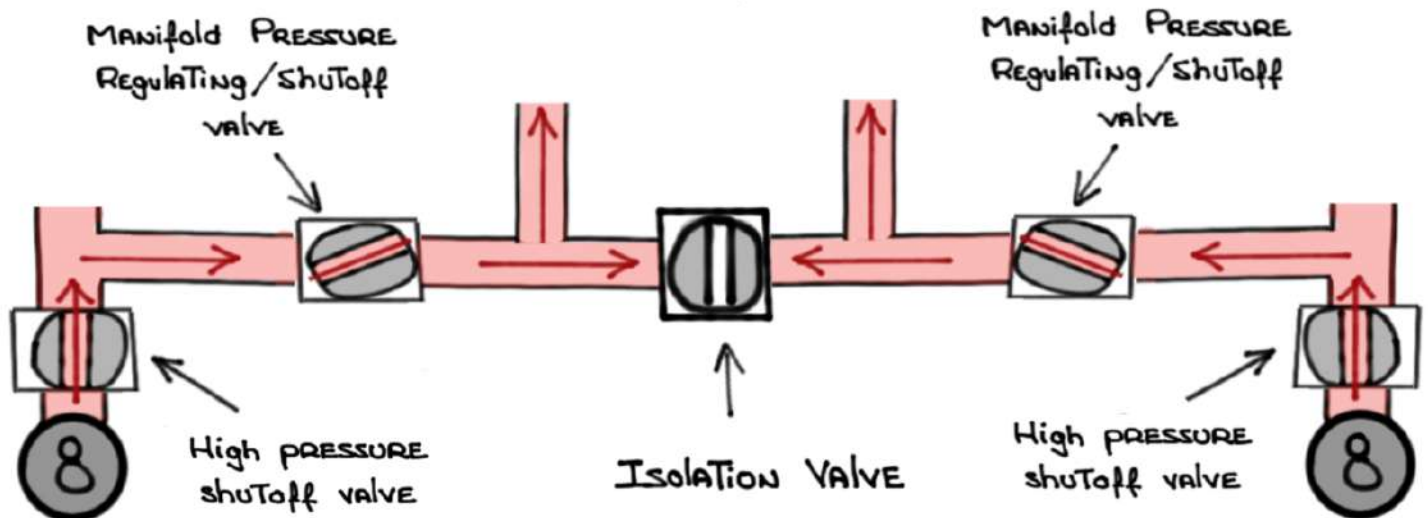
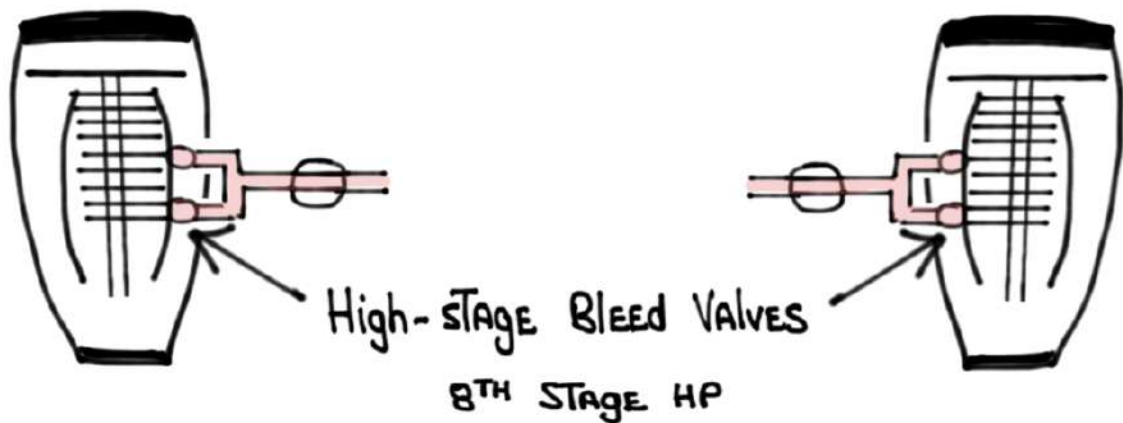
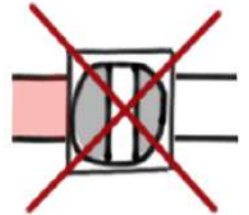

PRECOOLER HEAT EXCHANGER

- ENGINE BLEED AIR IS EXTREMELY **HOT** AND WOULD MELT ALUMINUM IF IT IS NOT COOLED
- THE PRECOOLER USES FAN AIR (LP) AND A HEAT EXCHANGER TO COOL ENGINE BLEED AIR DOWN
- THE PRECOOLER HEAT EXCHANGER IS LOCATED IN THE ENGINE PYLON

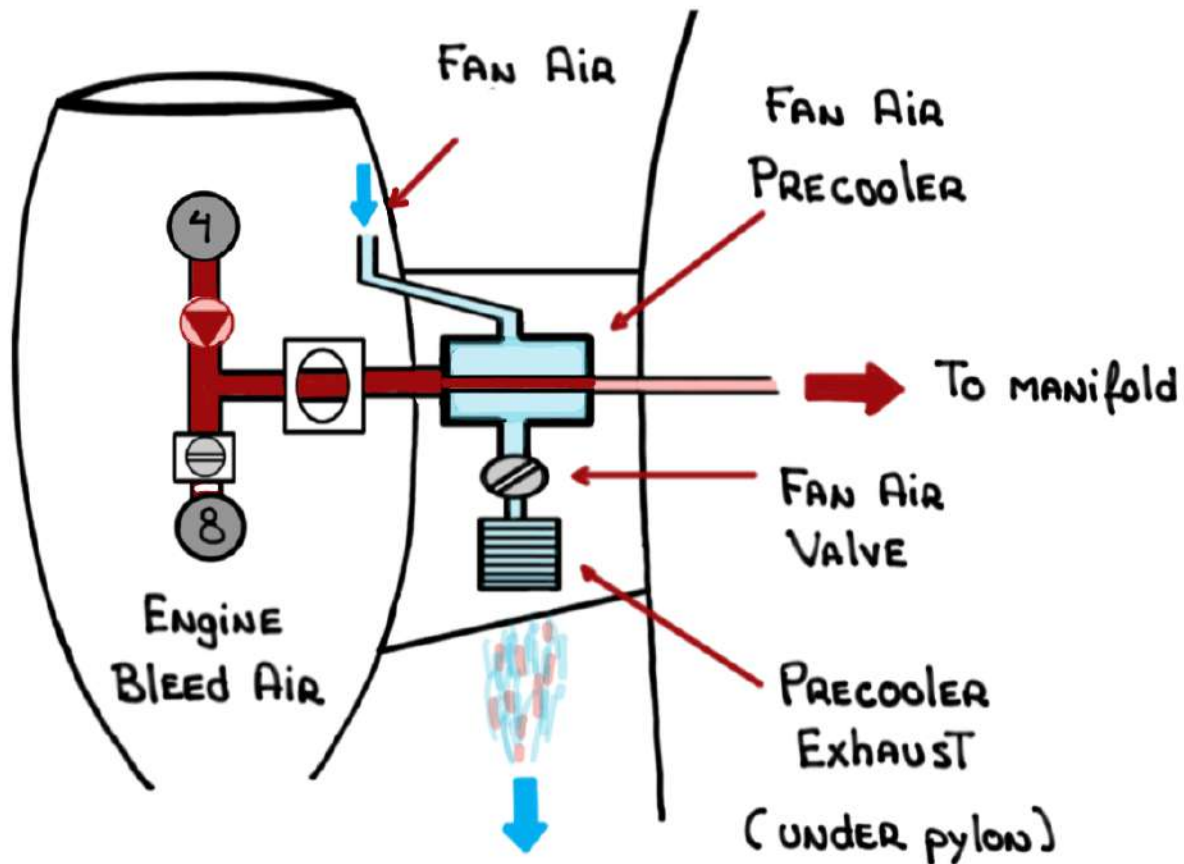

- The L
BAC R
BAC MONITOR PRECOOLER INLET AND OUTLET TEMPERATURE AND MODULATE THE OPENING OF THE FAN AIR VALVES AS NECESSARY

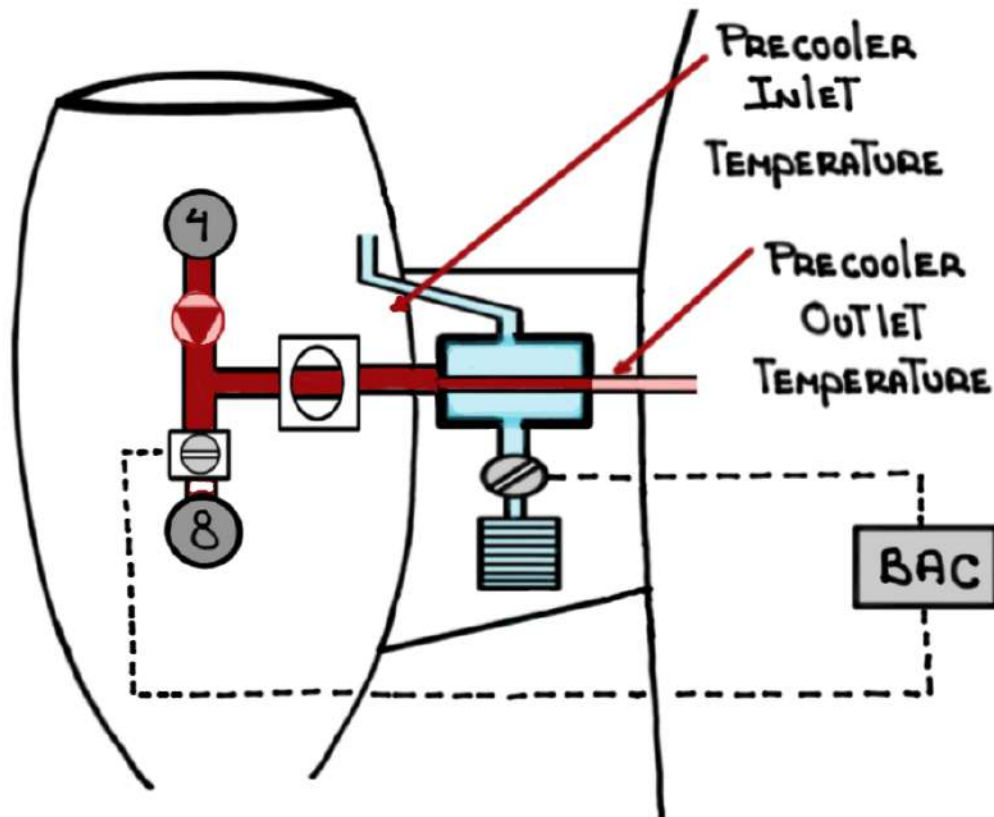

PRECOOLER INLET TEMPERATURE:

WHATEVER MID-STAGE (4TH) OR HIGH-STAGE (8TH)
IS PRODUCING

WHEN WAI IS ON THE 8TH STAGE VALVE IS
MODULATED FOR A MAXIMUM OF 700° F

PRECOOLER OUTLET TEMPERATURE:

- **400°F**

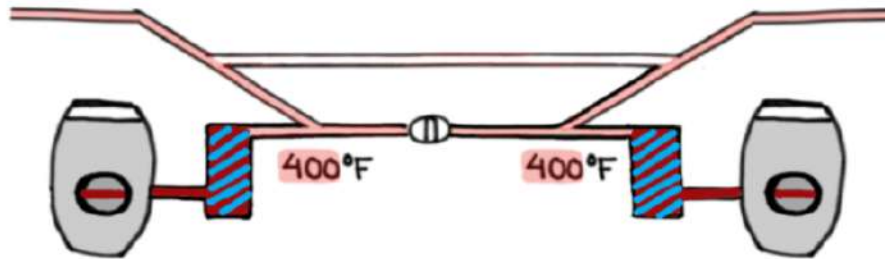

- **500°F** WHEN HOTTER AIR IS NEEDED TO TRAVEL THROUGH CROSSOVER DUCT (LONGER DISTANCE) DUE TO WING ANTI-ICE ON WITH A SINGLE BLEED SOURCE

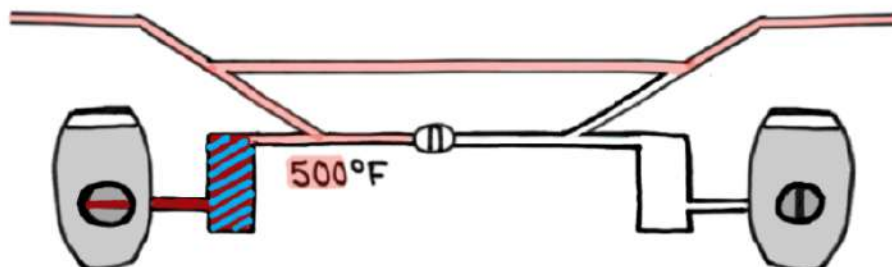
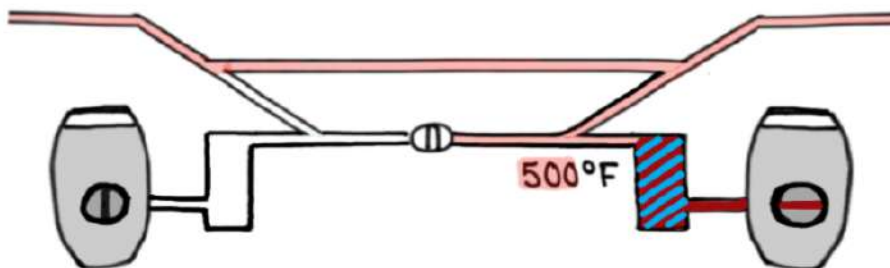

Wing ANTI-ICE SYSTEM

- Wing ANTI-ICE VALVES ARE ELECTRO-PNEUMATIC. THEY REQUIRE:

- ELECTRICAL POWER TO OPERATE
- PNEUMATIC PRESSURE TO OPEN

- IT USES **HOT** ENGINE BLEED AIR (MID OR HIGH-STAGE)

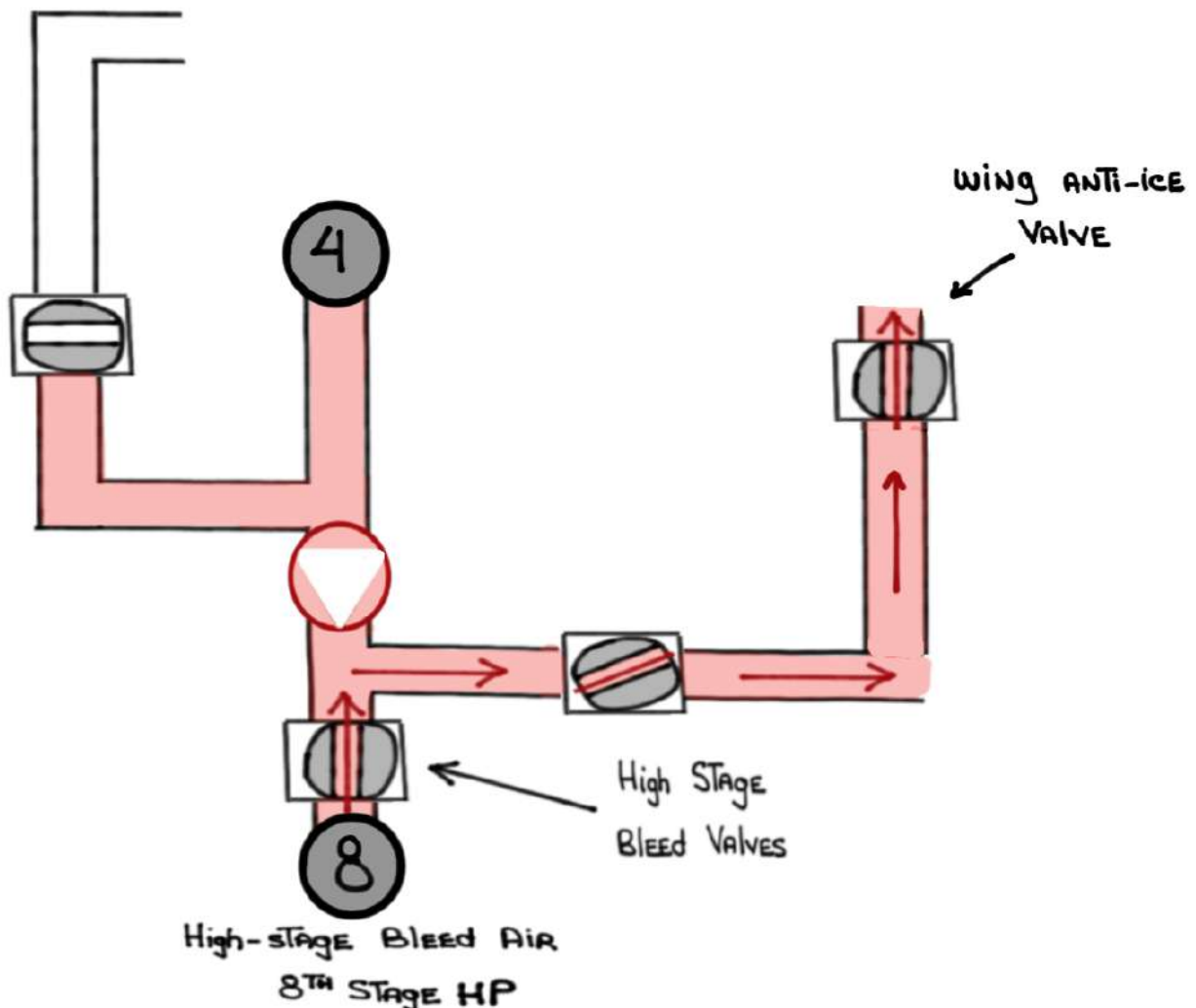

THE L
BAC R
BAC COMMAND:

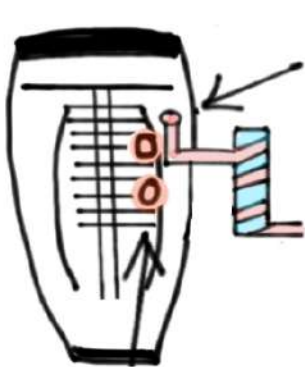

① FAN AIR VALVES TO MODULATE OPEN

② High-STAGE VALVES (8TH) TO OPEN
if Mid-STAGE (4TH) is INSUFFICIENT

WAI ON

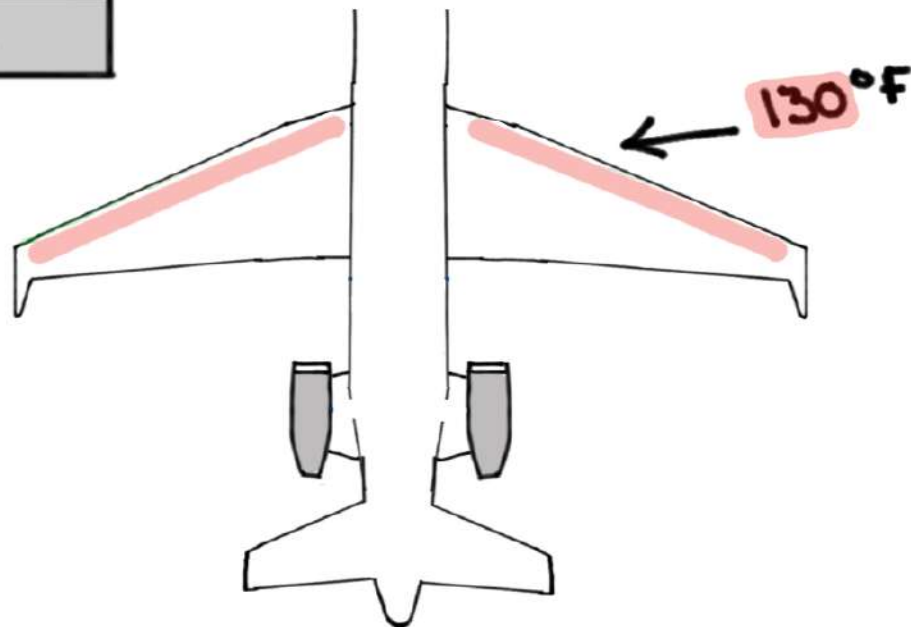

Cowl ANTI-ICE SYSTEM

- Cowl ANTI-ICE VALVES ARE ELECTRO-PNEUMATIC. THEY REQUIRE:

- ELECTRICAL POWER TO OPERATE
- PNEUMATIC PRESSURE TO CLOSE

- IT USES **HOT** ENGINE BLEED AIR (MID-STAGE only)

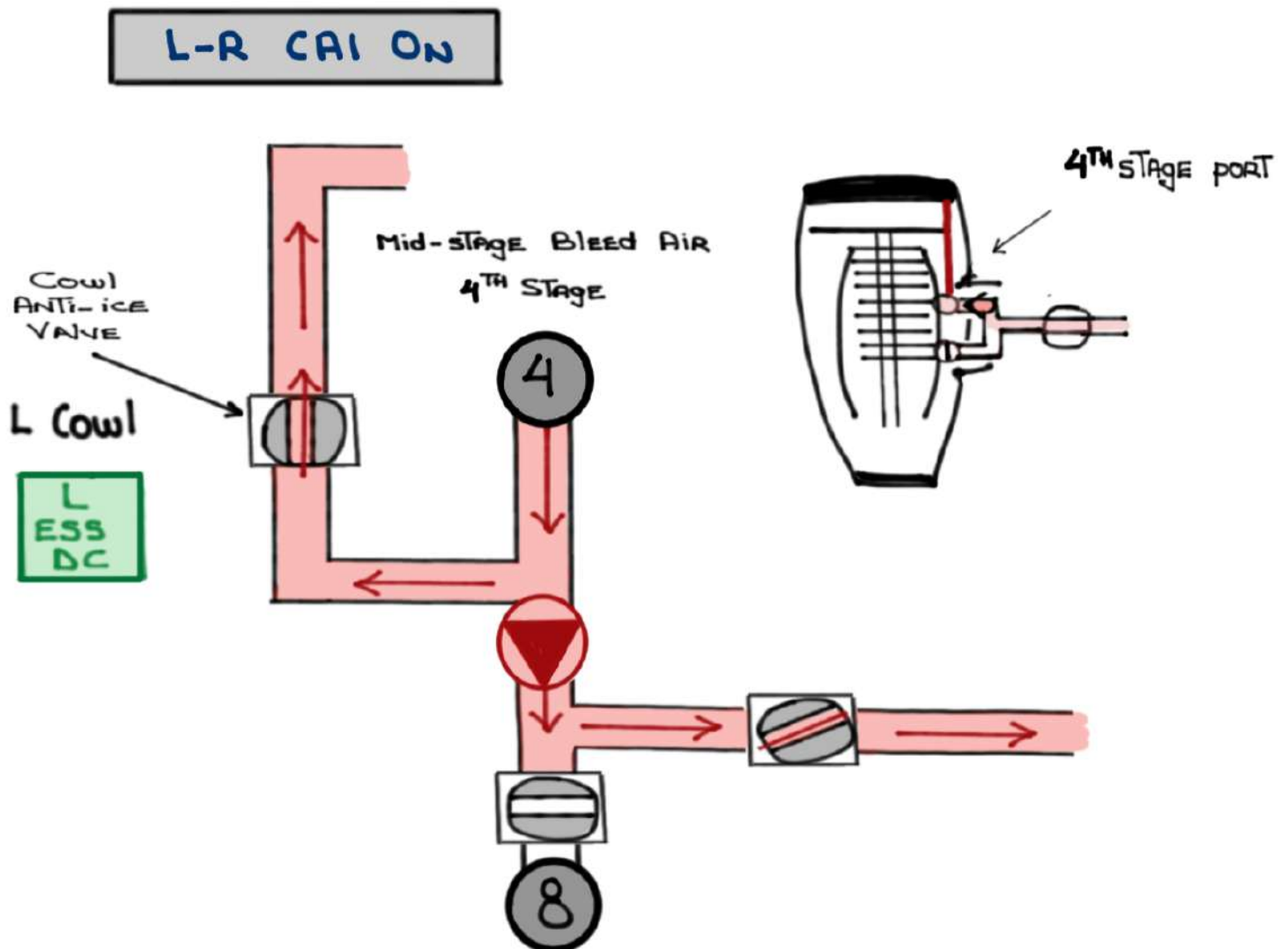

SET POINTS

SET POINTS ENSURE ADEQUATE PNEUMATIC **PRESSURE** AND **TEMPERATURE** AT VARIOUS POWER SETTINGS AND BLEED REQUIREMENTS

- Low power settings: 14-24 Psi
- Single ECS Pack ops: 35 Psi up to FL390
22 Psi above FL400

If Mid-Stage (4TH) is NOT ENOUGH THE BACs COMMAND THE High-Stage (8TH) VALVES TO MODULATE OPEN IN ORDER TO PROVIDE up to 44 ± 8 Psi

CONDITION	SOURCE	SET POINT (PSI)
Ground idle	8 TH	14
FLight idle	8 TH	24
THRUST > idle	4 TH	44 (400°F)
Wing ANTI-ICE (2) idle	8 TH (PRE-COOLER 700°F)	44 (500°F)
Wing ANTI-ICE (2) > idle	4 TH (PRE-COOLER 700°F)	44 (500°F)
Wing ANTI-ICE (1) > idle	4 TH (PRE-COOLER 700°F)	44 (500°F)
Single Pack	8 TH	35 ≤ FL390 22 > FL400

BLEED AIR PRESSURE SENSORS

> 75 Psi L BLEED PRESSURE High

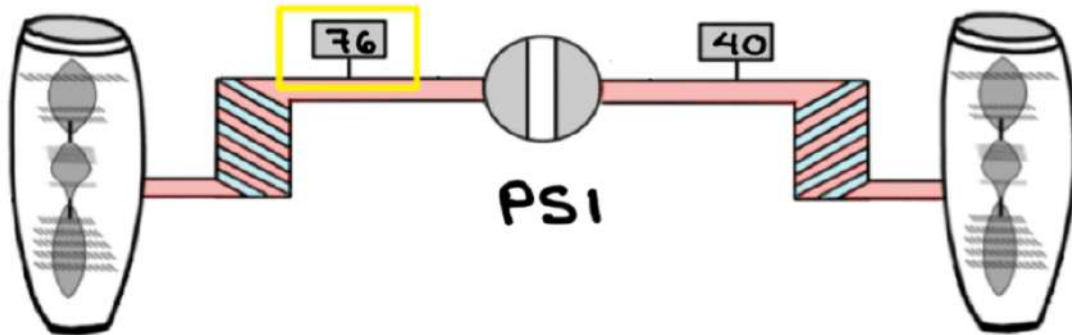

< 5 Psi ENGINE ABOVE idle R BLEED PRESSURE Low

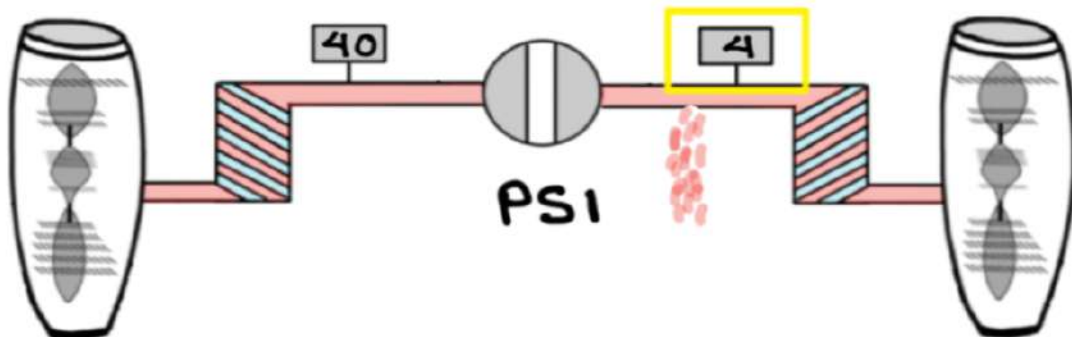

BLEED AIR TEMPERATURE SENSORS

L BLEED AIR HOT > 800°F INLET

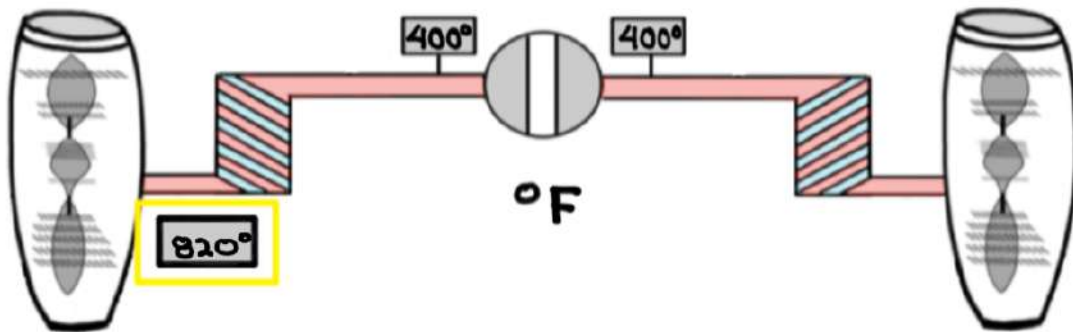

R BLEED AIR HOT > 550°F OUTLET

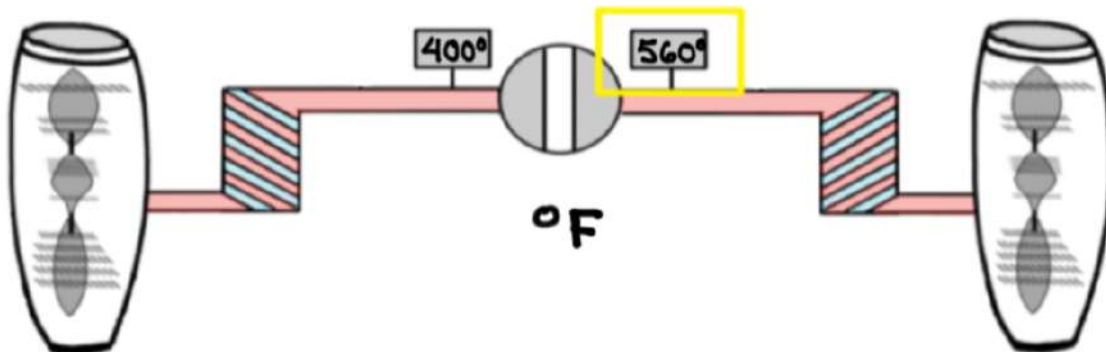

REMINDER: these system notes are intended for study purposes only. Always refer to official Gulfstream manuals and other approved references when operating your aircraft.

NOTE: these system notes are updated from time to time and what is posted on Code450.com will always be the most recent version.

Questions, comments or errors...please do send me an email:
ivan.luciani@gmail.com

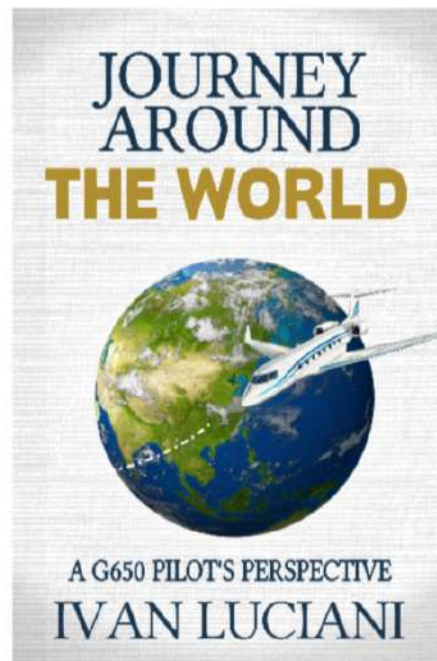
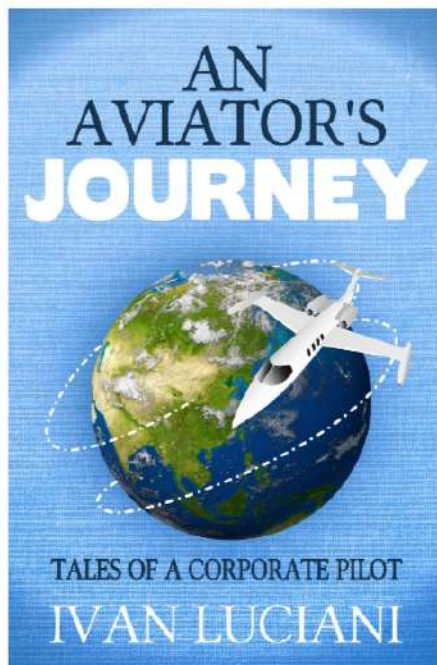

Thank you!