

G650 ICE & RAIN PROTECTION SYSTEM

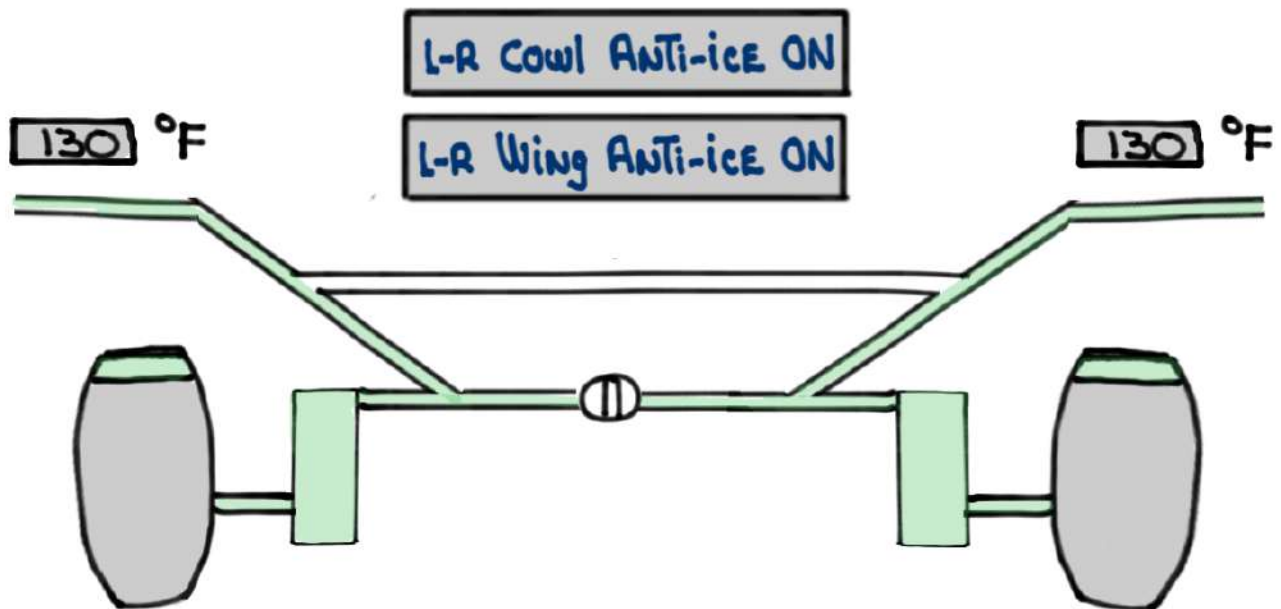

For study purposes only

The ICE AND RAIN PROTECTION SYSTEM IS ABOUT THE PREVENTION OR REMOVAL OF ICE FORMATION ON:

- ① ENGINE cowl inlets
- ② Wing LEADING EDGES

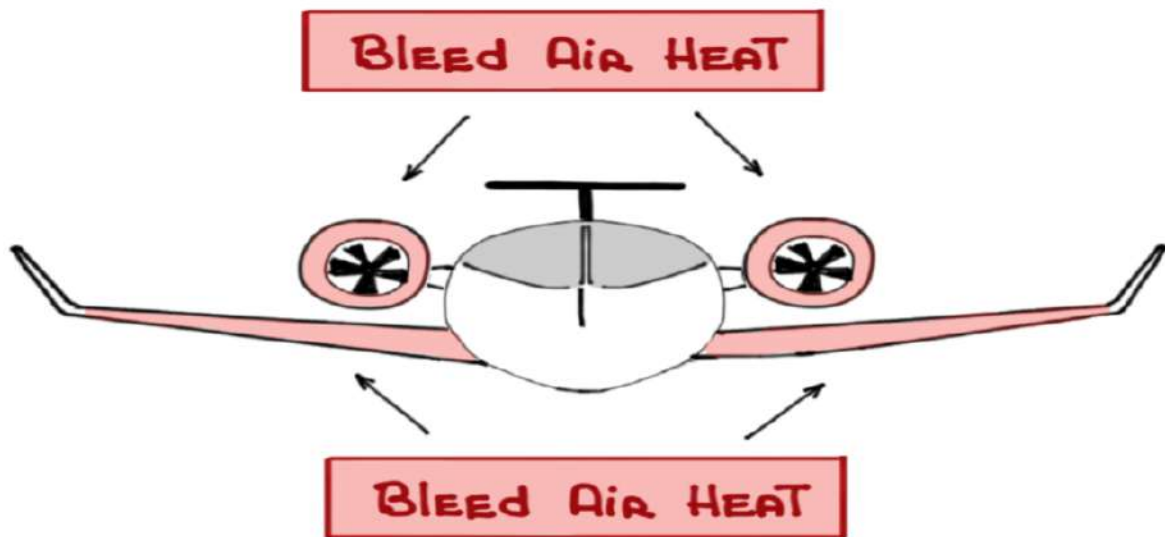

Through The USE of bleed air heat from The PNEUMATIC System

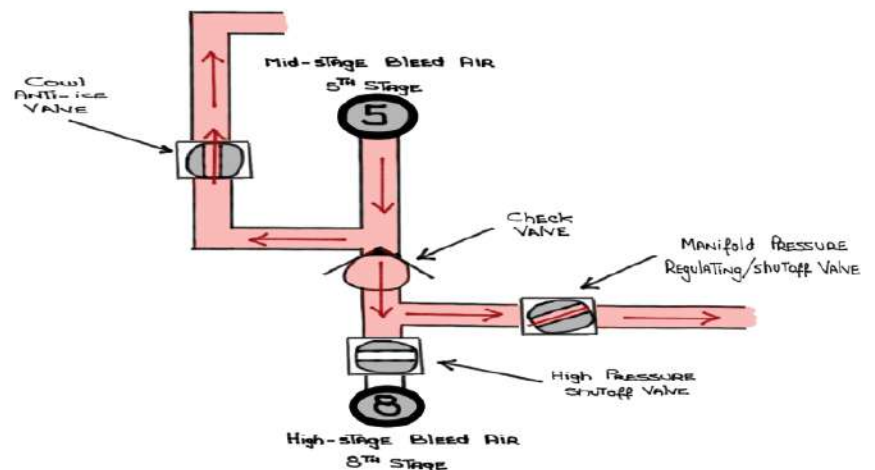

- ③ Air DATA PROBES (4)
- ④ TOTAL AIR TEMPERATURE (TAT) PROBES (2)
- ⑤ Windshield/cabin windows
- ⑥ EVS window

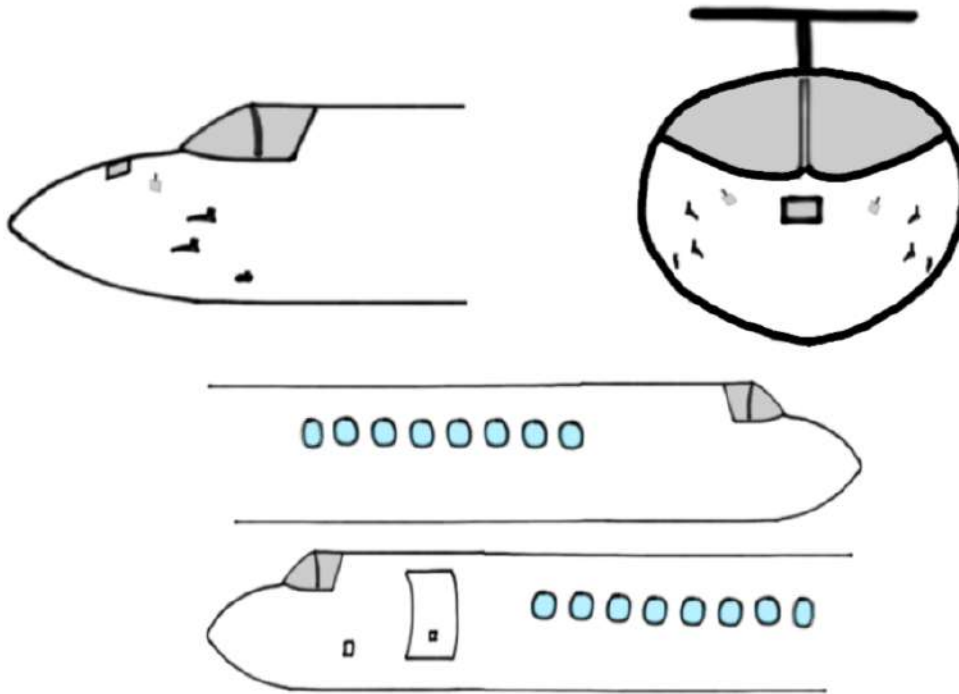

Through The use of power from The ELECTRICAL POWER SYSTEM

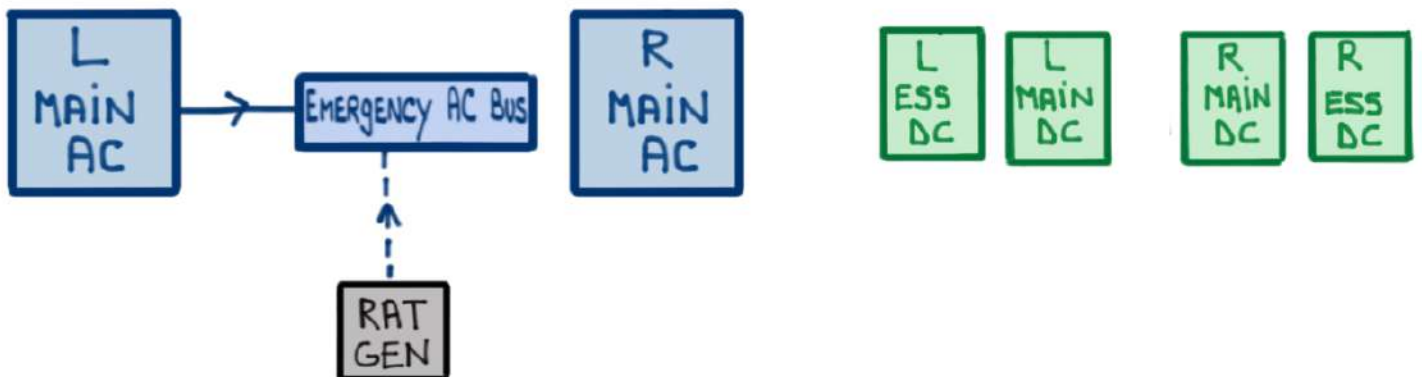

Icing Conditions

- Icing conditions exist when the static air temperature (SAT) on the ground or in flight is between +10 and -40°C and visible moisture is present in any form such as:
 - Rain
 - Snow
 - Clouds
 - fog with visibility < 1 sm
 - Sleet
 - Ice crystals
- Icing conditions also exist when the SAT on the ground and for takeoff is +10°C or below when operating on ramps, taxiways or runways covered with:
 - Surface snow
 - Ice
 - Standing water
 - Slush

These contaminants could be ingested or freeze on the engines, nacelles or engine probes

ICE DETECTION SYSTEM

- The ICE DETECTION SYSTEM consists of two (2) EXTERIOR PROBES located on both sides of the FUSELAGE below the pilot's and copilot's windows

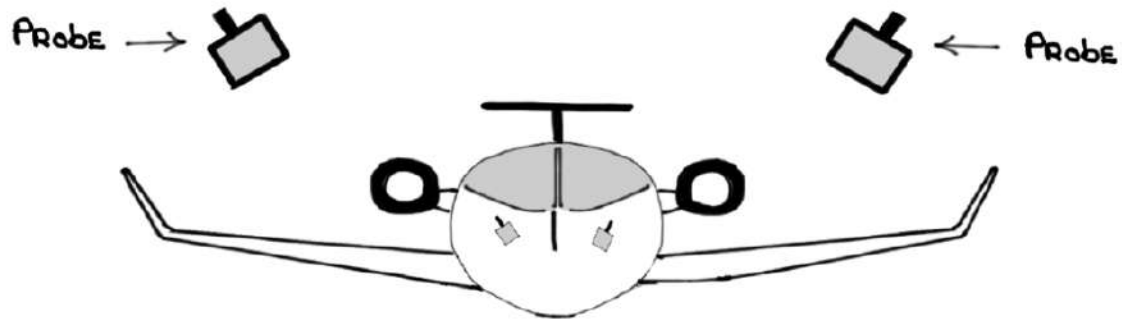

- ICE DETECTOR PROBES VIBRATE AT A FREQUENCY OF 40,000 Hz. ICE THICKNESS AFFECTS THE RESONATE PROPERTIES OF THE PROBES. ACTIVATION OF THE SYSTEM OCCURS WHEN PROBES ACCUMULATE 0.020 inches of ICE FORMATION. THIS DECREASES THE PROBE'S FREQUENCY BY APPROXIMATELY 130 Hz

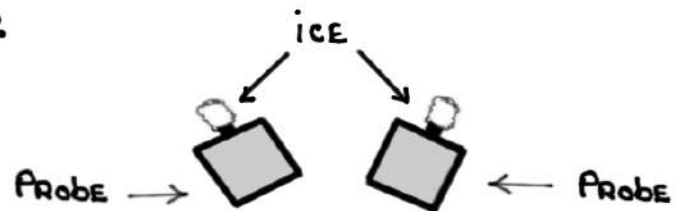

- When this happens the CREW is NOTIFIED OF THE PRESENCE OF ICE VIA A CAS MESSAGE

L-R ICE DETECTED

- The CREW IS THEN NOTIFIED:

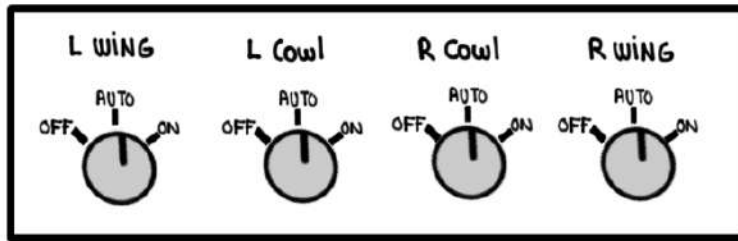

L-R Cowl ANTI-ICE ON

L-R Wing ANTI-ICE ON

- The PROBES ARE THEN HEATED TO MELT THE ICE AND ALLOW ITS VIBRATION FREQUENCY TO RETURN TO NORMAL SPEED - READY TO CONTINUE DETECTING MORE ICING. THE PROCESS CONTINUES UNTIL THERE IS NO MORE ICING

- When icing is no longer detected by the 

① **L-R ICE DETECTED** EXTINGUISHES AFTER ONE (1) MINUTE

② Cowl ANTI-ICE VALVES CLOSE AFTER THREE (3) MINUTES AND **L-R Cowl ANTI-ICE ON** EXTINGUISHES

③ Wing ANTI-ICE VALVES CLOSE AFTER FIVE (5) MINUTES AND **L-R Wing ANTI-ICE ON** EXTINGUISHES

- LEFT  =  Right  = 

Cowl ANTI-ice (CAI) SYSTEM

- THE CAI SYSTEM PROTECTS THE ENGINE COWL INLETS FROM ICE ACCUMULATION
- THE CAI SYSTEM CONSISTS OF TWO (2) SEPARATE AND INDEPENDENT SYSTEMS - ONE (1) FOR EACH ENGINE

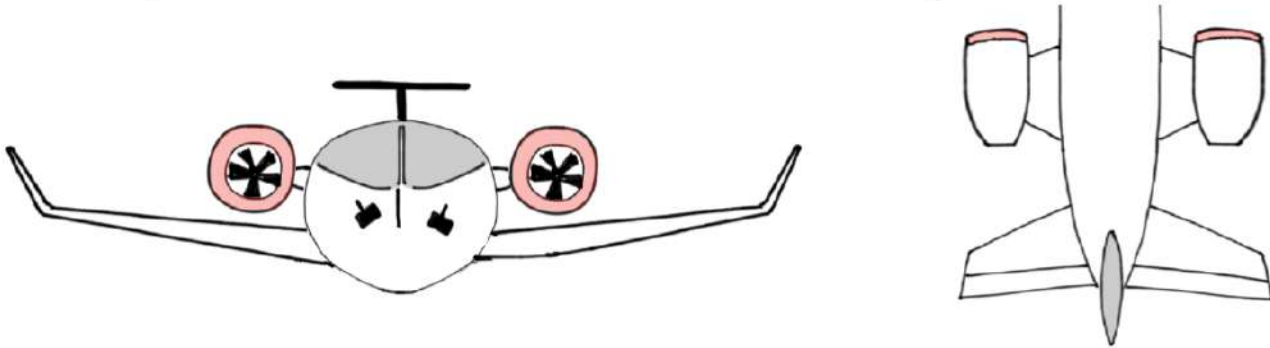

- IT USES **HOT** ENGINE BLEED AIR (MID-STAGE ONLY)

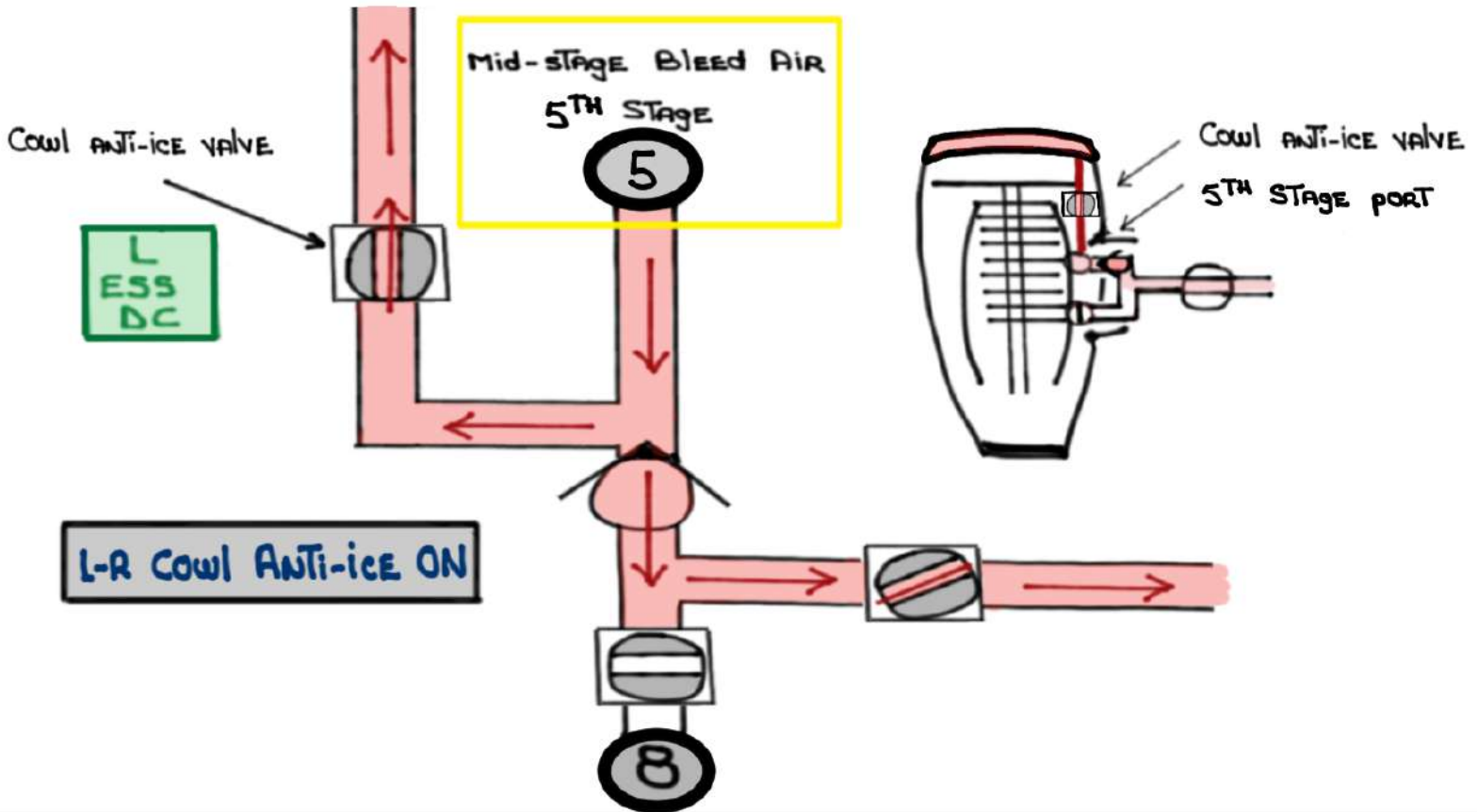

- CAI VALVES ARE ELECTROPNEUMATIC. They REQUIRE 28 VDC POWER AND PNEUMATIC PRESSURE TO CLOSE

ELECTRICALLY - CONTROLLED
PNEUMATICALLY - OPERATED > OPEN OR CLOSED

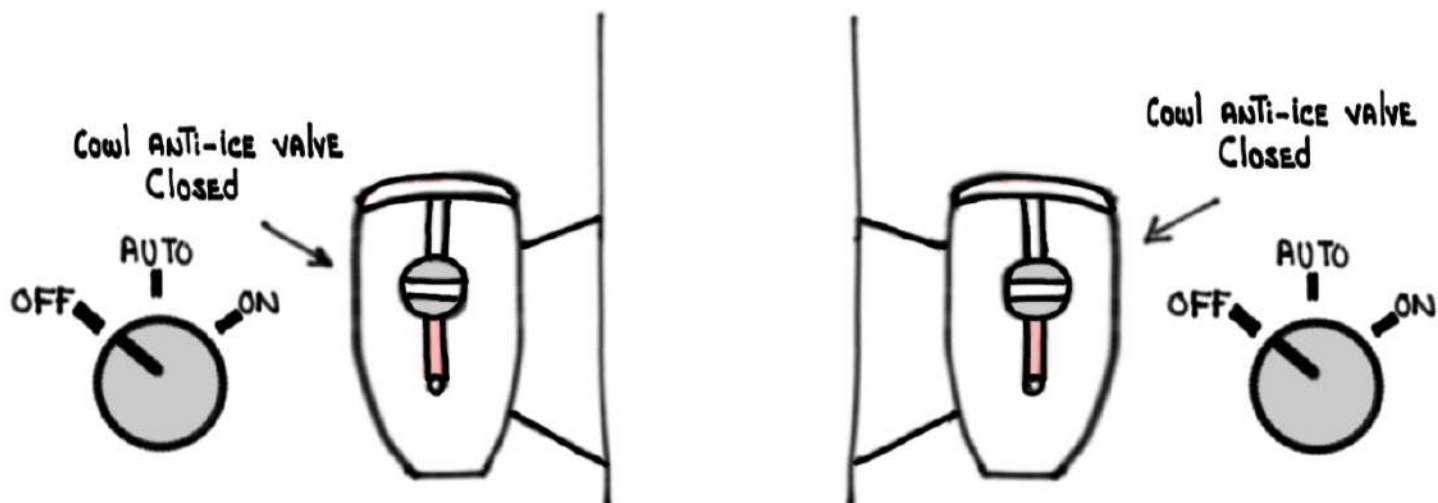

- CAI VALVES FAIL IN THE OPEN position

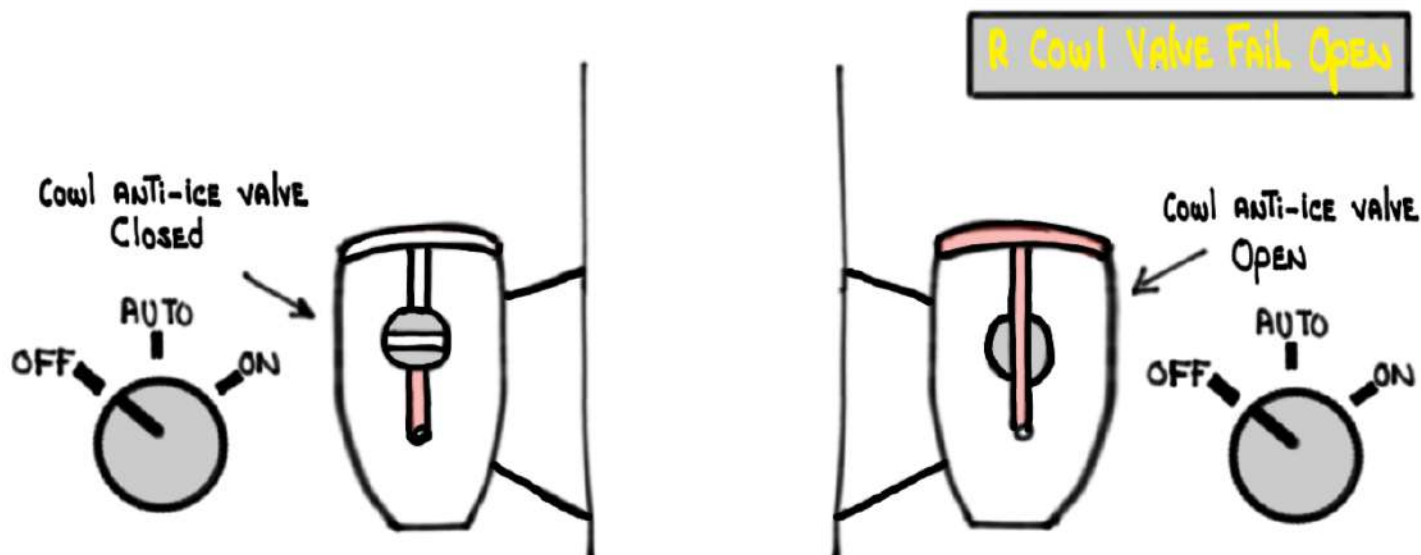

- CAI STATUS is indicated in PRESSURE (PSI) INSTEAD OF TEMPERATURE BECAUSE ENGINE BLEED AIR IS NOT MODULATED BY THE CAI SYSTEM. PRESSURE VARIES BASED ON ENGINE POWER

- **NORMAL** PRESSURE: 1.6 - 33 Psi

- **ABNORMAL** PRESSURE: < 1.6 > 33 Psi

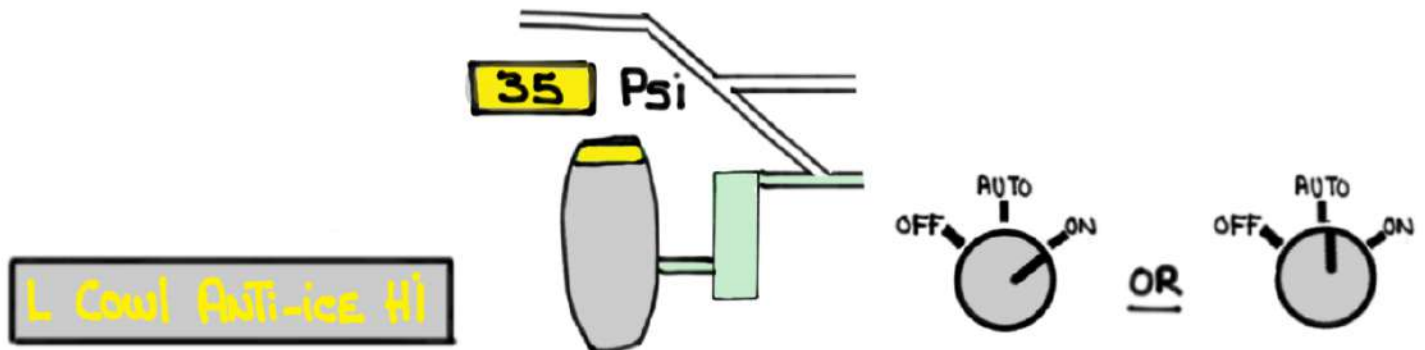

- MISCMPARE BETWEEN L AND R PRESSURES:



- AFTER PASSING THROUGH THE CAI SUPPLY DUCT, AND HEATING THE COWL LEADING EDGES, THE BLEED AIR IS EXHAUSTED OVERBOARD VIA VENTS LOCATED AT THE BOTTOM OF THE ENGINE COWLS

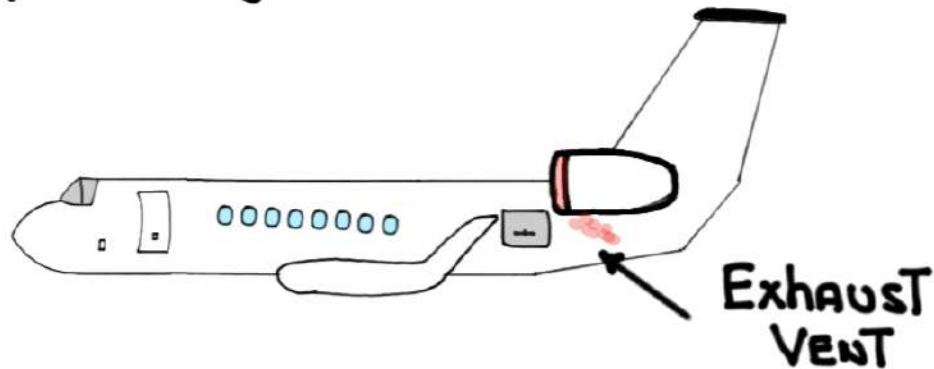

- THE ENGINE SPINNER HAS A PASSIVE DE-ICING DESIGN AND DOES NOT REQUIRE HEATING

THE TIP IS MADE OF RUBBER WHICH DISTORTS AND THIS SHEDS ANY ICE

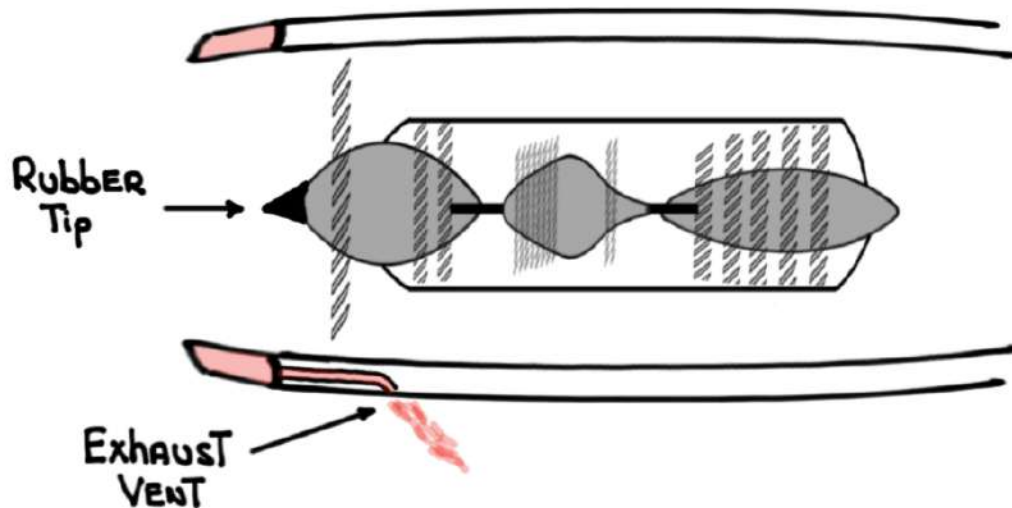

Wing ANTI-ICE (WAI) SYSTEM

- THE WAI SYSTEM PROTECTS THE WING LEADING EDGES AGAINST ICE ACCUMULATION
- THE WAI SYSTEM CONSISTS OF TWO (2) SEPARATE AND INDEPENDENT SYSTEMS - ONE (1) FOR EACH WING BUT JOINED BY A CROSSOVER DUCT
- IT USES **HOT** ENGINE BLEED AIR (MID OR HIGH-STAGE)

L-R Wing ANTI-ICE ON

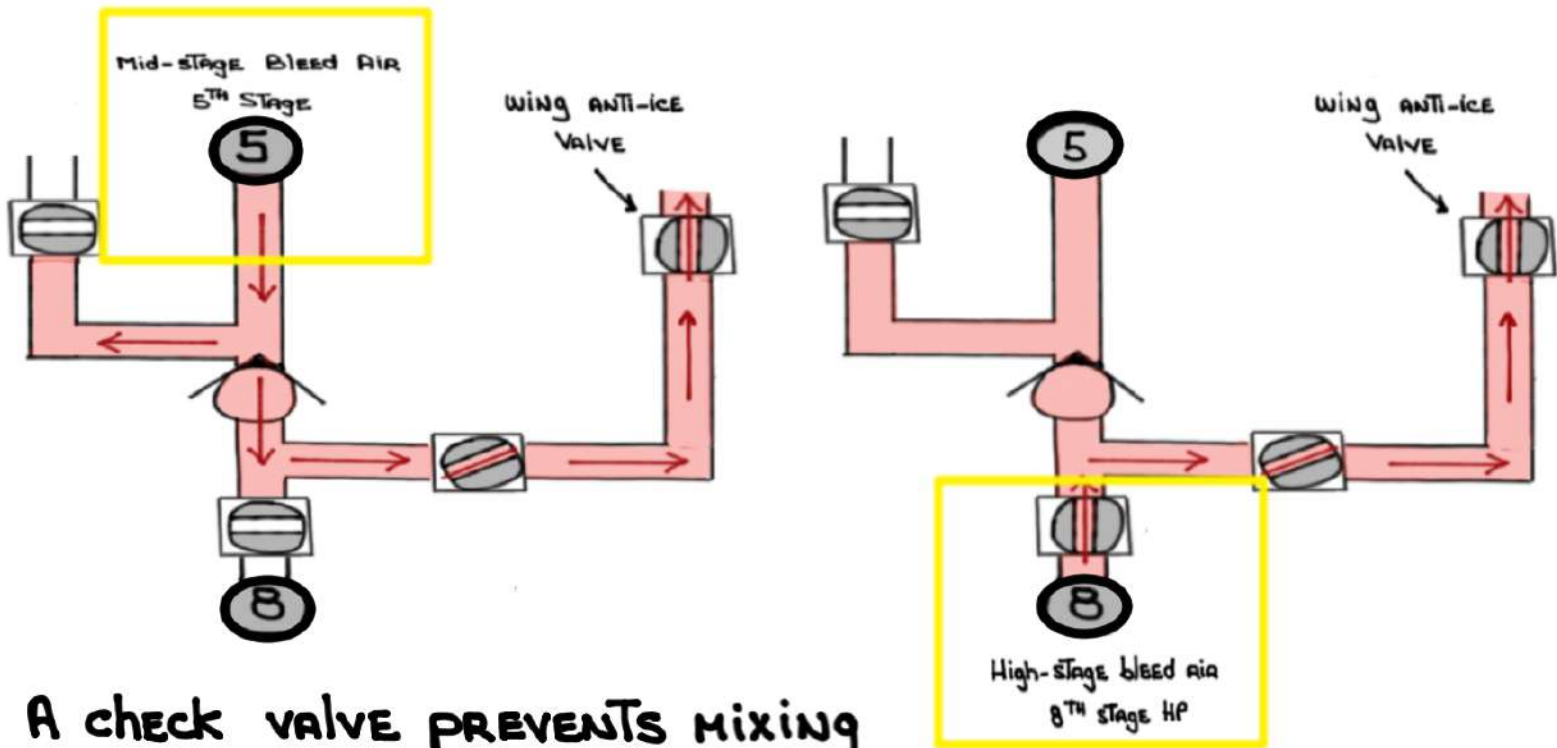

A check valve PREVENTS MIXING
BETWEEN 5TH AND 8TH STAGE
BLEED AIR

- AT low power settings, such as on descent, engine bleed air is extracted from the High-stage bleed air (8TH stage of the HP compressor)

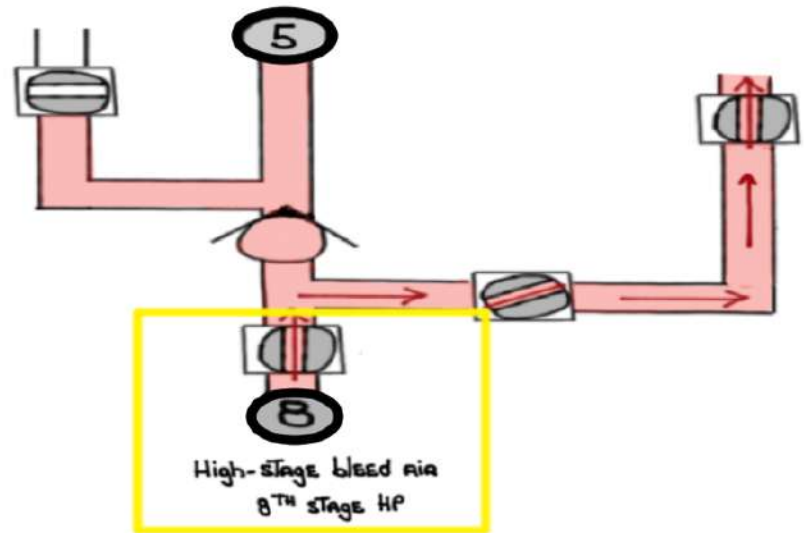

- The wing anti-ice valves are spring-loaded closed, pneumatically actuated, variable pressure regulator and shutoff valves
- Wing anti-ice valves fail CLOSED
- The WAIS, when required, should be selected ON AT LEAST TWO (2) MINUTES BEFORE TAKEOFF. THAT'S how long it takes for a fault to be ANNUNCIATED VIA A CAS MESSAGE:

L Wing Temperature Low

L Wing Overheat

- AT LEAST ONE (1) ENGINE BLEED AIR SWITCH MUST BE ON FOR WAI OPERATION

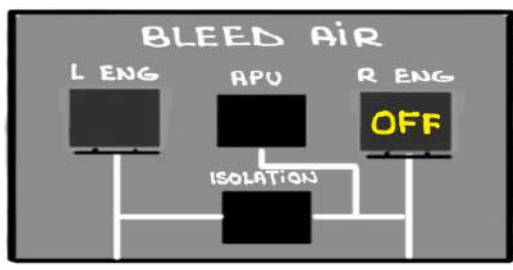

- Wing anti-ice usage is limited to 41,000' during single bleed air system or single WAIS operation
 - Wing anti-ice usage above 41,000' requires a minimum speed of 0.85 M in order to prevent an ECS pack over-temperature condition
- **Hot** engine bleed air flows through WAI valves
- Two (2) WAI valves
 - Located in the tail compartment
 - Butterfly-type valves
 - Spring-loaded closed (fail close)
 - Pneumatically actuated
 - Variable pressure regulator and shutoff valves
 - Provides regulated **Hot** air to its respective wing leading edge

- The wing ANTI-ICE VALVES MODULATE IN ORDER TO MAINTAIN A **130°F** TEMPERATURE TARGET

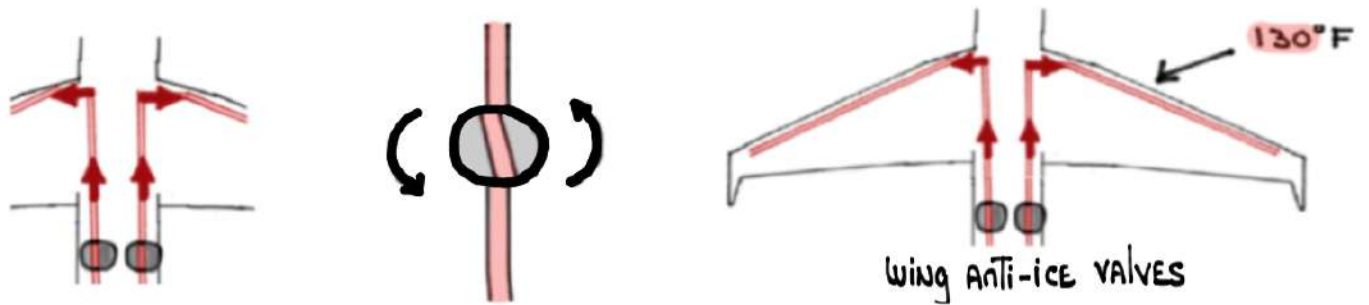

- The **HOT** ENGINE bleed air THEN PASSES THROUGH THE MAIN WHEEL WELL BEFORE EXITING OVERBOARD

- IN CASE OF ENGINE FAILURE A CROSSOVER DUCT ALLOWS BLEED AIR FROM THE OPERATING ENGINE TO HEAT UP THE INOPERATIVE SIDE'S LEADING EDGE

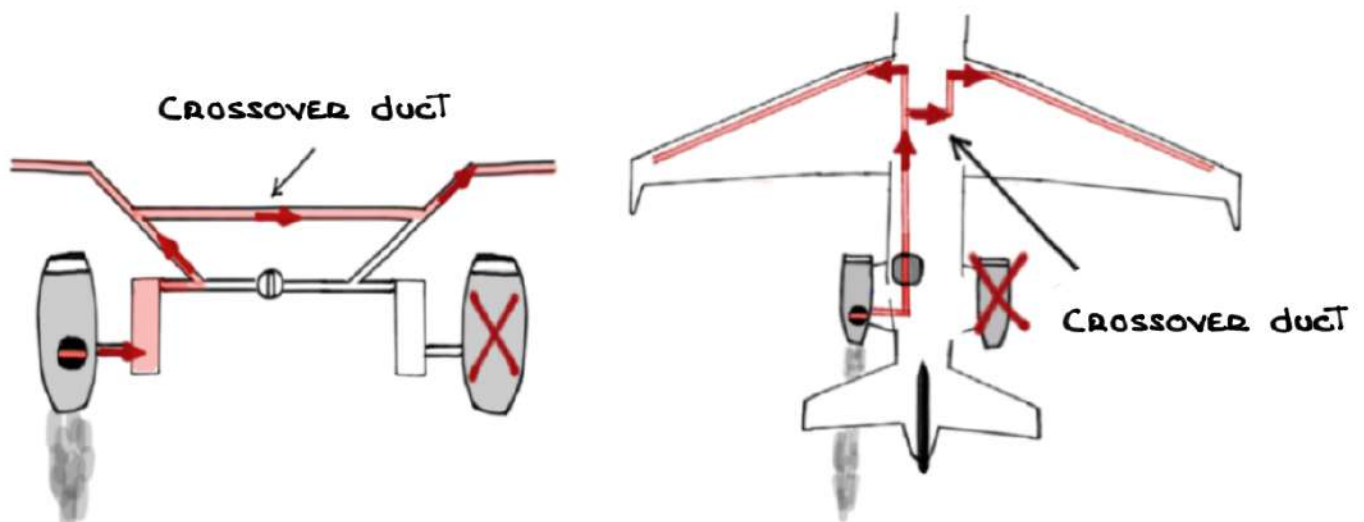

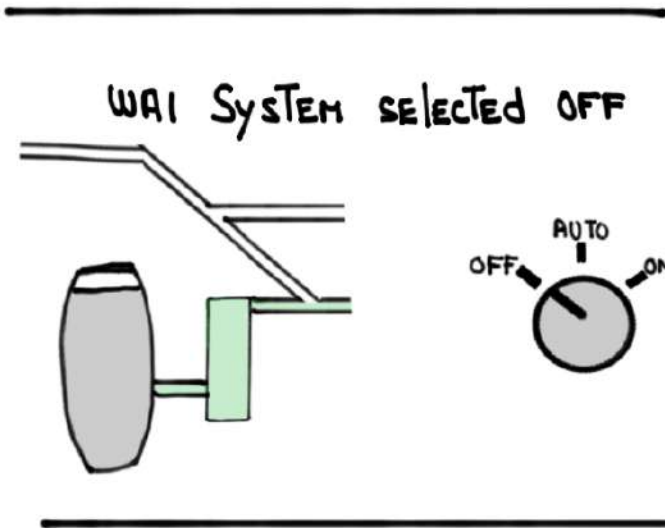
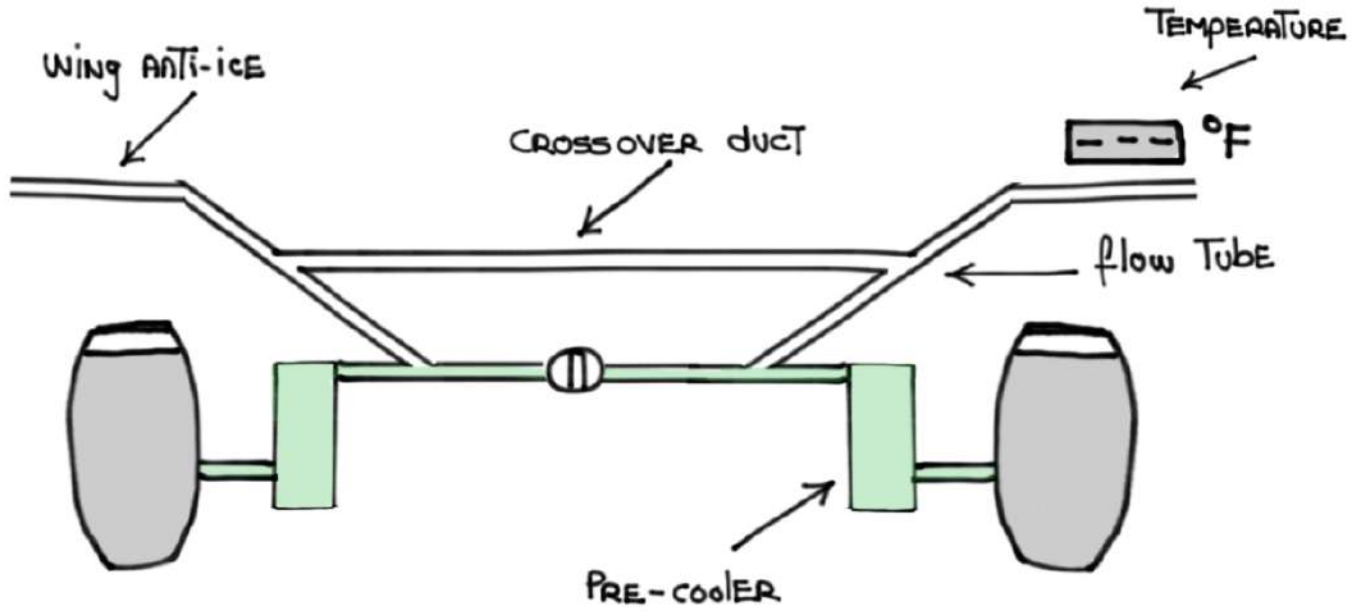

WAI SYSTEM SELECTED ON
TEMPERATURE INCREASING

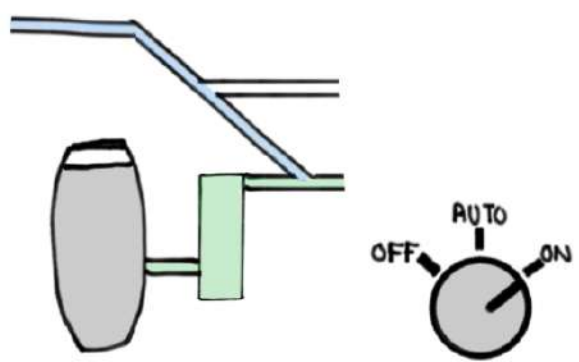

WAI SYSTEM SELECTED ON
TEMPERATURE $\geq 100^{\circ}\text{F}$ $< 180^{\circ}\text{F}$

OR

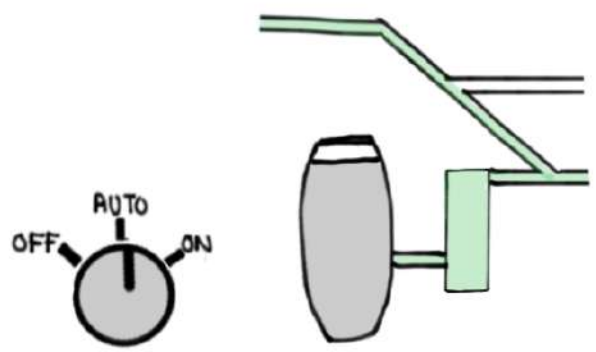

WAI SYSTEM SELECTED ON

> 2 MINUTES: TEMPERATURE < 100°F

WAI SYSTEM SELECTED ON

TEMPERATURE ≥ 180°F

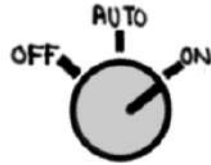
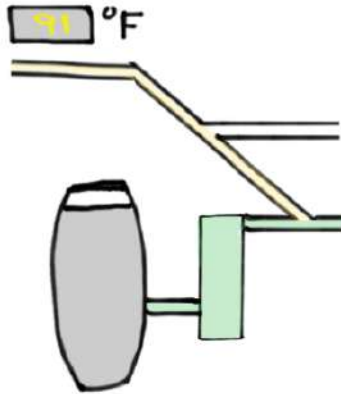

OR

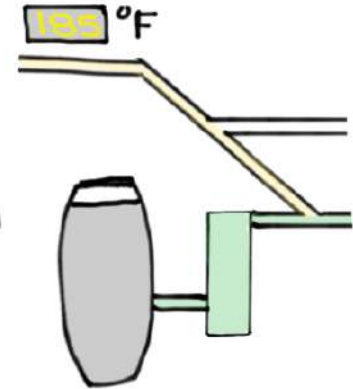
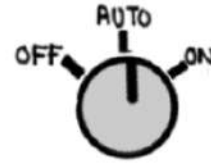

L Wing TEMPERATURE LOW

L Wing OVERHEAT

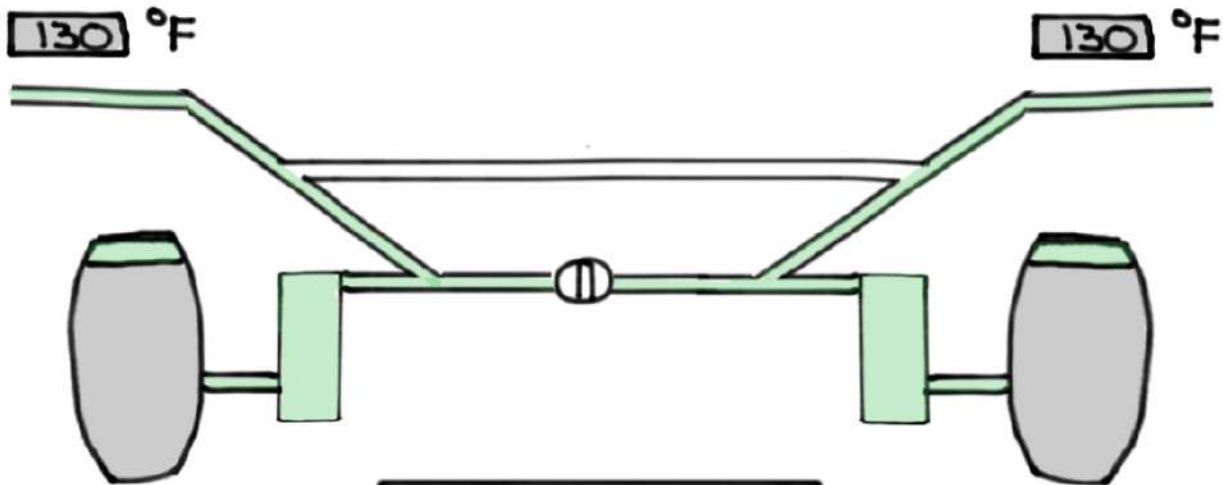

L-R Wing ANTI-ICE ON

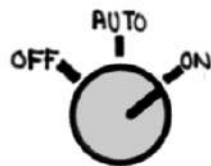

OR

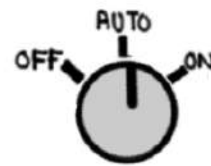

PRIOR TO ENTERING icing conditions, OR when icing is DETECTED by THE ICE DETECTION SYSTEM, THE CREW SHOULD SELECT WING AND COWL ANTI-ICE SYSTEMS TO ON

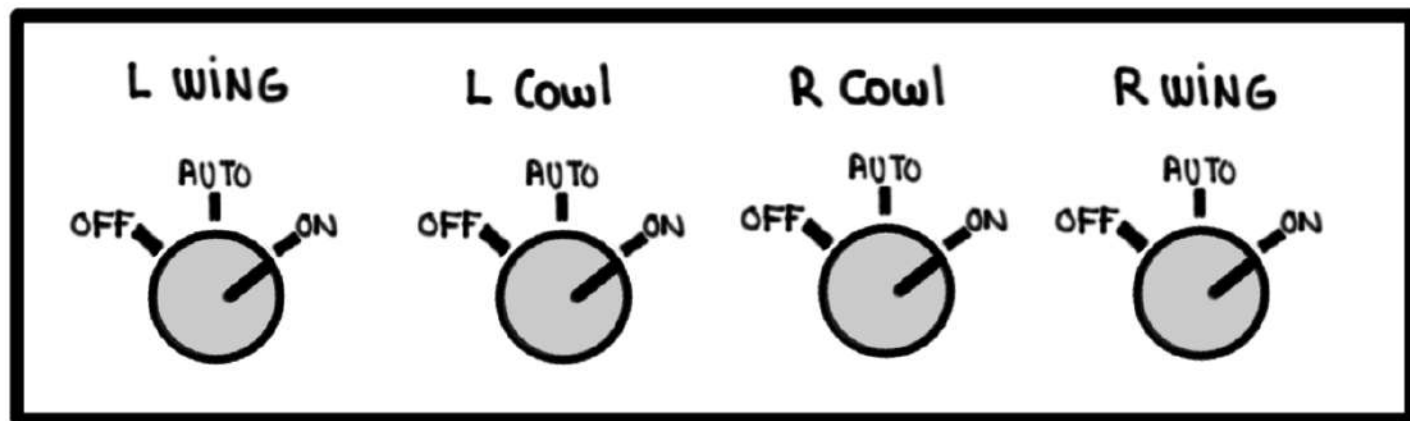

Holding in icing conditions:

- ① 180 KCAS MINIMUM
- ② Flaps 0° (UP)

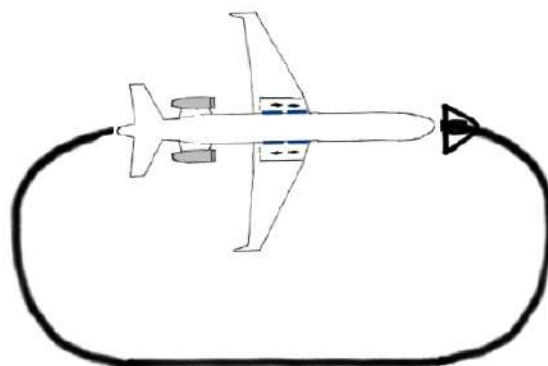

Use of flaps in icing conditions RESTRICTED TO:

TAKEOFF



APPROACH

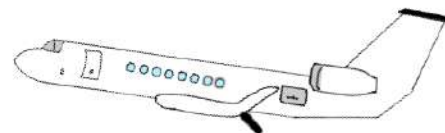

LANDING



- If The WAI SYSTEM is in AUTO The wing ANTI-ICE VALVES OPEN AUTOMATICALLY AND ALLOW **HOT** ENGINE BLEED AIR To HEAT up The wing LEADING EDGES

- If The CAI SYSTEM is in AUTO The cowl ANTI-ICE VALVES OPEN AUTOMATICALLY AND ALLOW **HOT** ENGINE BLEED AIR To HEAT up The ENGINES' cowl INLETS

FL350

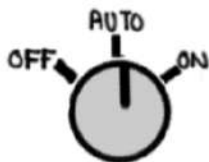

AUTO:



GROUND

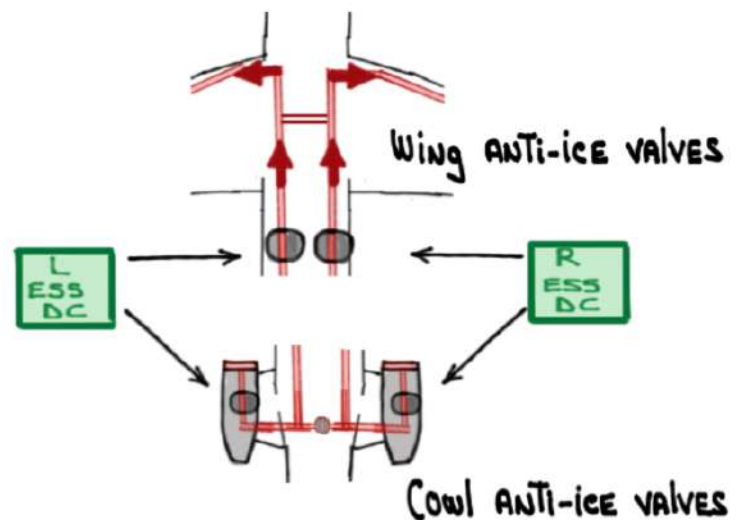
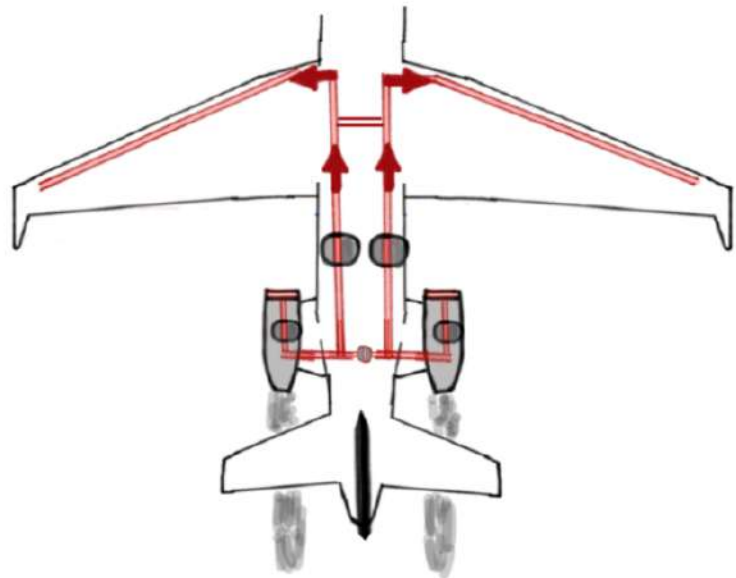

- Automatic activation of the WAIS is inhibited above **35,000'**. If already selected ON they'll remain ON
- **L-R ICE DETECTED** CAS is inhibited on the **ground** because **AMBER** CAS messages are considered "NO GO" messages
- BR725 ENGINE: if OAT is $< 10^{\circ}$ the use of WAIS/CAIS will NOT result in a decrease in takeoff thrust. FADEC maintains EPR even if automatic activation of anti-ice systems occurs during takeoff and climb segments
- Cowl and wing anti-ice switches must remain OFF during engine start. The AUTO function does NOT inhibit activation on the **ground** and, if activated during engine start, it would divert bleed air away and result in a **hot start**

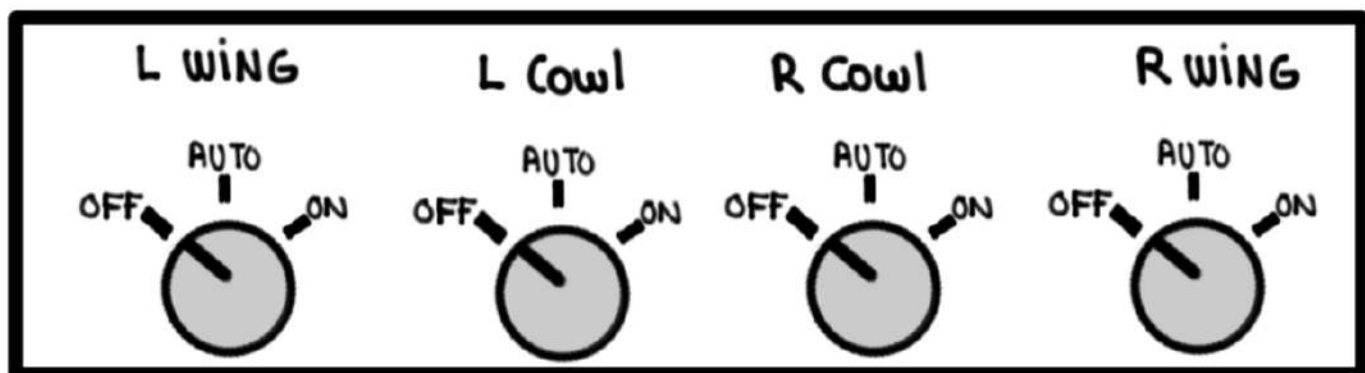

Air DATA PROBES AND TOTAL AIR TEMPERATURE (TAT) PROBES

- PROBES ARE ELECTRICALLY HEATED TO PREVENT ICE FORMATION

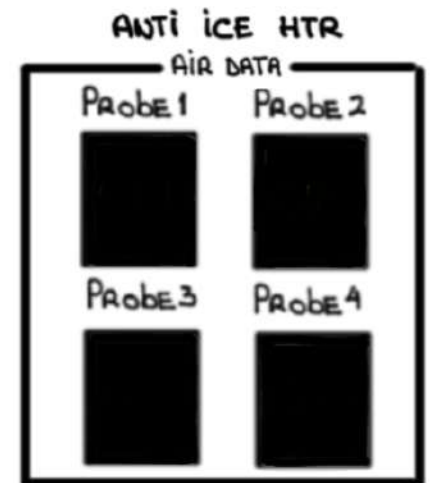
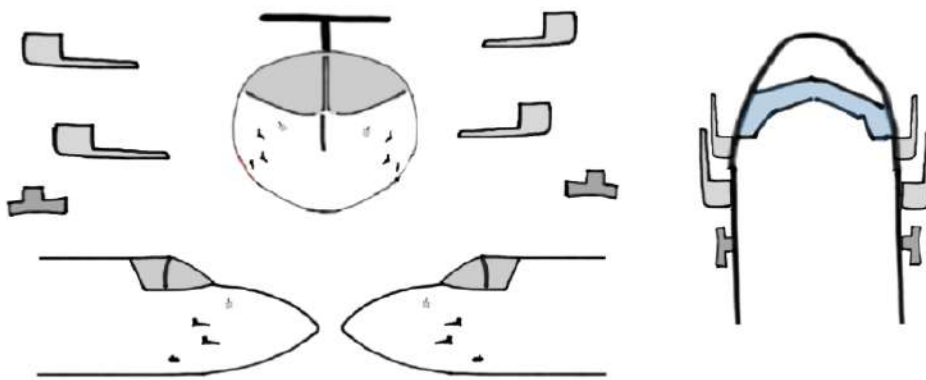

- PROBE HEATERS ARE TURNED ON AFTER ENGINE START
- Below 60 KTS Air DATA PROBES ARE HEATED TO 150°C
- Above 60 KTS Air DATA PROBES ARE HEATED TO 300°C
- TAT PROBES ARE ONLY HEATED ABOVE 60 KTS, OR WHEN BOTH THRUST LEVERS ARE ADVANCED BEYOND 30°

Air DATA PROBES HEATERS AND FLIGHT CONTROLS

AFTER SELECTING ANTI-ICE HEATERS TO ON WAIT FIVE (5) SECONDS BEFORE MOVING THE FLIGHT CONTROL SURFACES TO PREVENT **FCC1** **FCC2** FROM REVERTING TO **DIRECT** MODE

FCC ALTERNATE Mode

NORMAL

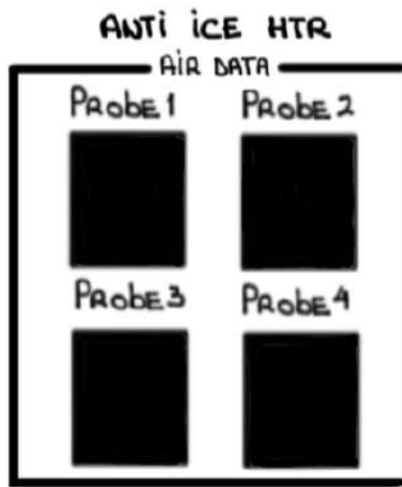

+ 5 SECONDS =

OK



OK



Windshield HEAT

- PROTECTS pilot AND copilot front/side windshields FROM ICE ACCUMULATION AND fogging
- ELECTRICALLY-POWERED HEATING ELEMENTS WITHIN EACH windshield
- HEATS windshields slowly TO AVOID RAPID TEMPERATURE CHANGES
- Windshield HEAT cycles ON AND OFF TO ENSURE A WINDOW TEMPERATURE BETWEEN 104° - 114° F

Windshield HEAT

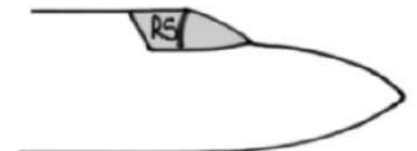
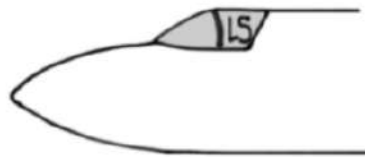
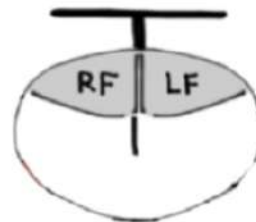

- IN THE EVENT OF A DUAL IDG AND APU GEN FAILURE THE RAT GEN CAN POWER THE HEATING ELEMENTS FOR THE SIDE WINDOWS ONLY

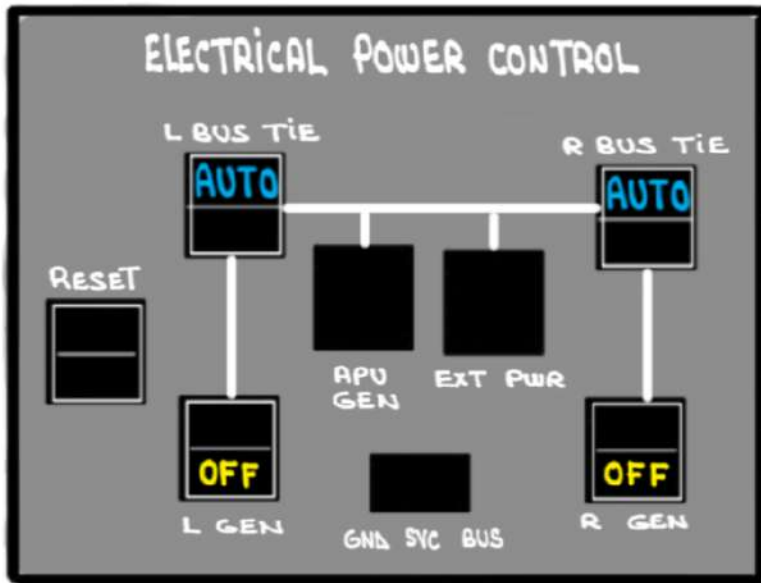

L-R AC POWER FAIL

L-R AC POWER FAULT

APU POWER FAIL

RAT GENERATOR ON

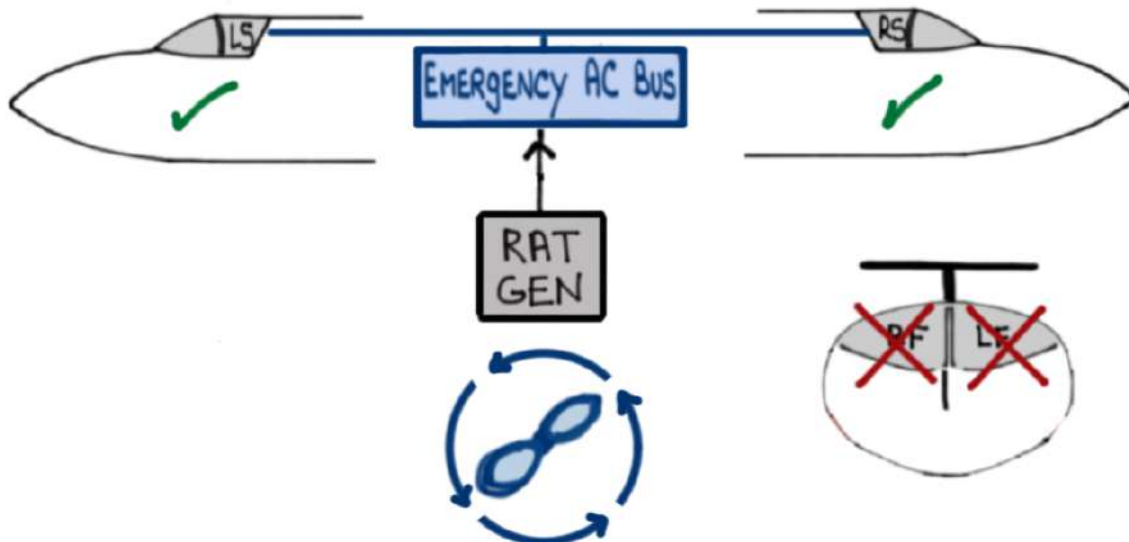
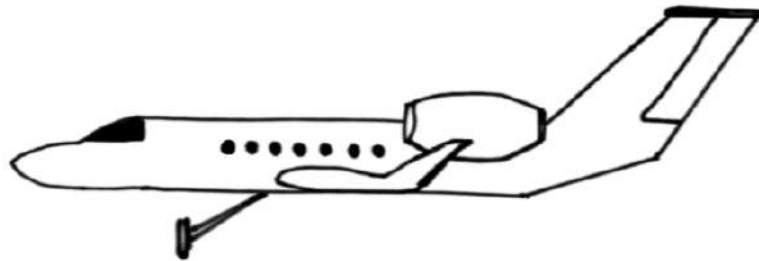

Cabin Window HEAT

- PROVIDES ELECTRIC HEAT TO SIXTEEN (16) CABIN WINDOWS
- PREVENTS THE FORMATION OF CONDENSATION
- POWER TO THE CABIN WINDOW HEATERS IS APPLIED WHEN THE CABIN WDO HT pushbutton in THE COPLOT OVERHEAD PANEL (COP) IS ON AND:
 - AIRCRAFT IS AIRBORNE, OR
 - MAINTENANCE IS BEING PERFORMED, OR
 - CABIN WINDOWS NEED TO BE DEFROSTED WHILE AIRCRAFT IS ON THE GROUND

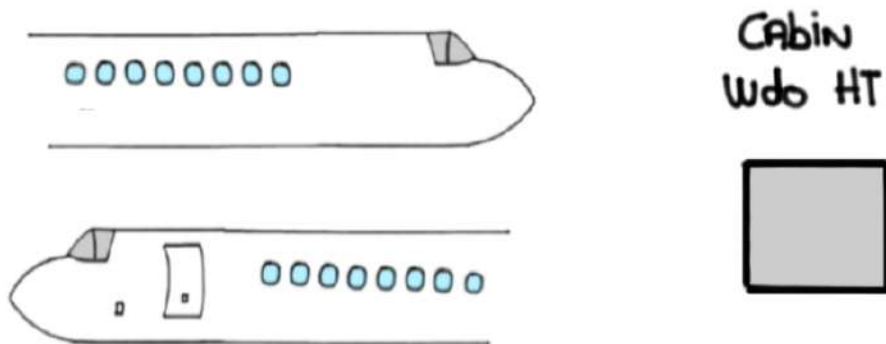

- MANUAL OVERRIDE CAPABILITY GROUND ONLY - TEN (10) MINUTE LIMIT OR IRREPARABLE DAMAGE CAN OCCUR DUE TO LACK OF AIRFLOW

EVS Window HEAT

- Provides protection against ice accumulation on the EVS windshield

- Electrically heated (12-14°C)

- Modes:

① MANUAL: Two (2) MINUTES ON

② AUTOMATIC:

- WOW Air / L-R Ice Detected /

- Cyclic HEAT applied To EVS windshield as follows:

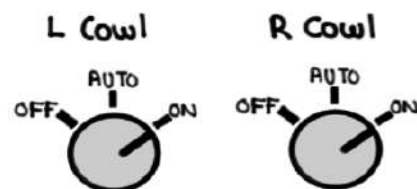
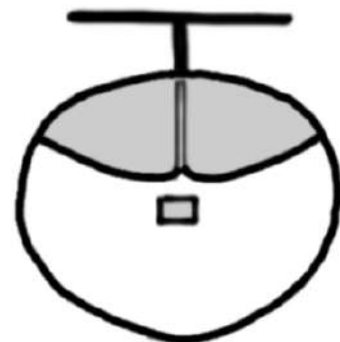

• GEAR UP: ONE (1) MINUTE ON / SEVEN (7) MINUTES OFF

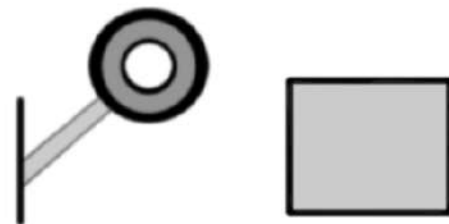
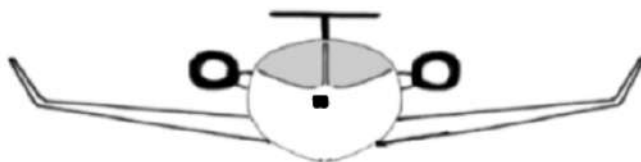

• GEAR DOWN: CONTINUOUSLY

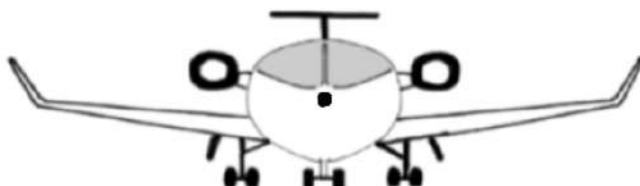

REMINDER: these system notes are intended for study purposes only. Always refer to official Gulfstream manuals and other approved references when operating your aircraft.

NOTE: these system notes are updated from time to time and what is posted on Code450.com will always be the most recent version.

Questions, comments or errors...please do send me an email:
ivan@code7700.com

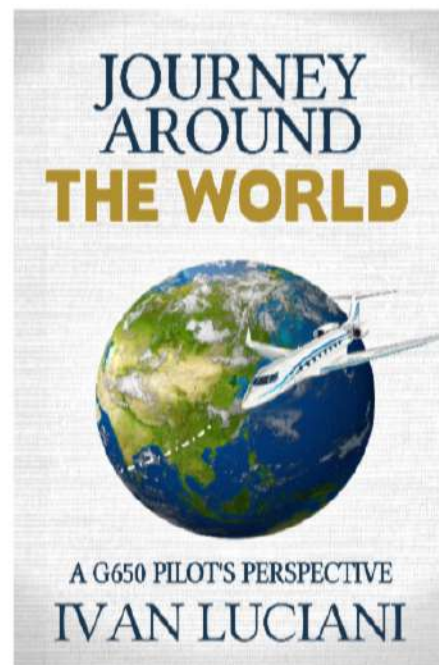
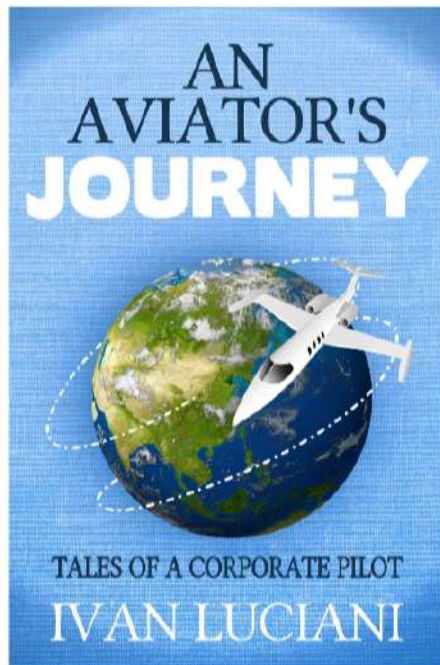

Thank you!